



TERMO
Trench heaters



About the Company

Trademark ISAN represents a traditional Czech manufacturer of heating bodies with a history and experience stretching back more than 60 years. ISAN Radiátory s.r.o. has been developing and manufacturing trench heaters for more than 18 years. Top-notch technological procedures and the progressive thinking of our designers and developers always guarantee high technical and aesthetic parameters of the products, thanks to which the products have become popular on the Czech and foreign market. We export 90% of our production into the countries of the European Union.

Our prime objective is the satisfaction on the customer's part and service. Ecological processing with maximal consideration for the environment goes without saying. The production is controlled by ISO 9001:2016 system. Moreover, all heating bodies comply with certification requirements applicable for current legislative regulations of individual states in a way that corresponds to the strictest standards. The certification process for the Czech Republic took place in Testing Institute for Mechanical Engineering in Brno, notified body ES1015.

The complete ISAN portfolio consists of a wide range of radiant trench heaters and lamella-fitted radiators ISAN EXACT, trench heaters with a lamellar heat exchanger ISAN ECOLITE, trench heaters ISAN TERMO, column radiators ISAN ATOL, ribbed-tube radiators ISAN SPIRAL, glass radiators ISAN JOY and, last but not least, bathroom radiators ISAN MELODY, in which case the company was the first manufacturer of this type in the Czech Republic.

A speciality of ISAN Radiátory s.r.o. is creating made-to-measure radiators based on the requirements of our customers.

Basic Information 1–19

	About the Company	8	Self-standing trench heaters
2	Basic Information	9	Peripheral ledge
3	EC technology	10	Atypical trench heaters
3	Construction	13	Acoustics
4	Overview components TERMO	14	Accessories TERMO
6	Grilles		

TERMO electric trench heaters 20-27

20	TERMO – ELECTRIC TRENCH HEATER
24	WITH FAN, HEATING FET - Electric trench heaters with fan
25	NATURAL CONVECTION, HEATING FEK - Electric trench heaters with natural convection
26	FET, FEK - outputs and acoustic parameters
27	Trench heating wiring diagram

TERMO -trench heaters for heating systems 28-131

28	TERMO WITH FAN	102	TERMO NATURAL CONVECTION
32	WITH FAN, HEATING FRT - Fan-assisted trench heater with lamellar heat exchanger, heating, dry environment	106	NATURAL CONVECTION, HEATING FRK - Trench heater with lamellar heat exchanger, heating, dry environment
84	WITH FAN, HEATING / COOLING FRC, FRD - Fan-assisted trench heater with lamellar heat exchanger, heating and cooling, dry environment	124	NATURAL CONVECTION, HEATING, HUMID ENVIRONMENT FRM - Trench heater with lamellar heat exchanger, heating, humid environment
94	WITH FAN, HEATING, HUMID ENVIRONMENT FRB - Fan-assisted trench heater with lamellar heat exchanger, heating, humid environment		TECHNICAL INFORMATION
98	WITH FAN AND POWER SUPPLY 24 V DC FRZ, FZC, FZD - Fan-assisted trench heaters with installed power supply 24 V DC	126	Heat exchanger - Hydraulic resistance
		129	Electric connection of trench heaters with fan
		130	Electrical diagram

The coding 132-133

132	The coding of trench heaters TERMO
-----	------------------------------------



marking of an environmentally friendly product with low consumption, economical operation, working on the basis of safe direct current voltage of 24 V DC

- | | | | |
|---|--|--|--|
| All-electric trench heater | Cooling, convector with cooling in summer | Power input for trench heaters with fan | 2 pipe (single circuit heating / cooling system) |
| Trench heater with fan, increased output with forced convection | Trench heater for wet environment | The convector includes an Al-Cu lamellar heat (cold) exchanger | 4 pipe (double circuit heating / cooling system) |
| Heating, a trench heater for hot water heating system with forced circulation | Acoustic power parameters of trench heaters with fan | 24 V DC power supply installed in the trench convector | suitable for heat pumps and low-temperature gradient systems |

We reserve the right to changes and misprints.

Basic Information about TERMO

Use

Trench heaters are suitable for places with large glass walls. They are installed in commercial and administrative buildings, commercial centres, entrance halls and other public spaces. They are also common in residential buildings, in which they are used to heat living rooms, corridors, halls and indoor gardens.

Placement

Trench heaters are installed in the floor and therefore do not occupy any space suitable for furniture and do not interfere with the interior the way traditional heating bodies do. The final look of the trench heater depends on the upper design grille. Available grilles are made of anodized aluminium, wood and stainless steel.

Operation

The trench heaters with fan are controlled with a digital thermostat with continuous control. This secures comfortable and economical operation at optimal thermal comfort and low noise level. All parts of the trench heaters work on the basis of safe direct voltage of 24 V DC. (with the exception of the heating unit in all-electric heaters)

The low volume of water in heat exchangers secures fast warming up to operating temperature. The trench heaters provide heating at the moment when it is necessary without a delay during start-up and without inertia when the requirement is cancelled. By generating their own heat, electric heat exchangers also eliminate any potential heat loss in piping.

Function

A “thermal screen” is created in front of a glazed surface, which separates the cold surface from the indoor environment. At the same time air flow prevents condensation of air humidity on the surface. The trench heaters are installed in the floor with the heat exchanger nearer to the window. The vertical and horizontal distribution of temperatures in the heated space is even and favourable conditions are created to secure thermal comfort.

Air flow is comparable with heat transmission provided by traditional heating bodies located on the wall under the window. The reversed arrangement in the floor is possible (the heat exchanger towards the room's centre, the ventilator at the window).

Low temperature heating systems

High performance models with modern tangential ventilators 24 V DC EC allow for the implementation into low temperature heating systems making use of thermal pumps and other ecological heating sources.

BMS

Trench heaters with the EC fans technology combined with a modern digital thermostat can easily be incorporated into building management systems (BMS). Communication with the superior system either directly or through a thermostat with an output for communication with the KNX protocol. For other systems it is possible to use protocol converters.



EC technology

This technical advancement affects all areas of human activity and enables the requirements for low energy consumption and safety of devices to be met. Modern 24 V DC fans with electronically commutated (EC) motors are among the most important elements of the trench heaters.

Properties of 24 V DC EC FANS

- › Safe voltage of 24 V DC
- › Remarkably low energy consumption, calculated in units of watts
- › Comfortable continuous speed control using a voltage of 0...10 V DC
- › Pulse to start the motor at low speeds
- › Protection function when the rotor is stopped by an outside influence
- › Synchronization of fan speeds
- › Long service life of the motor with electronic control
- › Simple implementation into complex control systems



The fans in TERMO trench heaters with their rotors cover the entire length of the exchanger. Even at low speeds they achieve optimum performance and a quiet operation.

Trench heater design

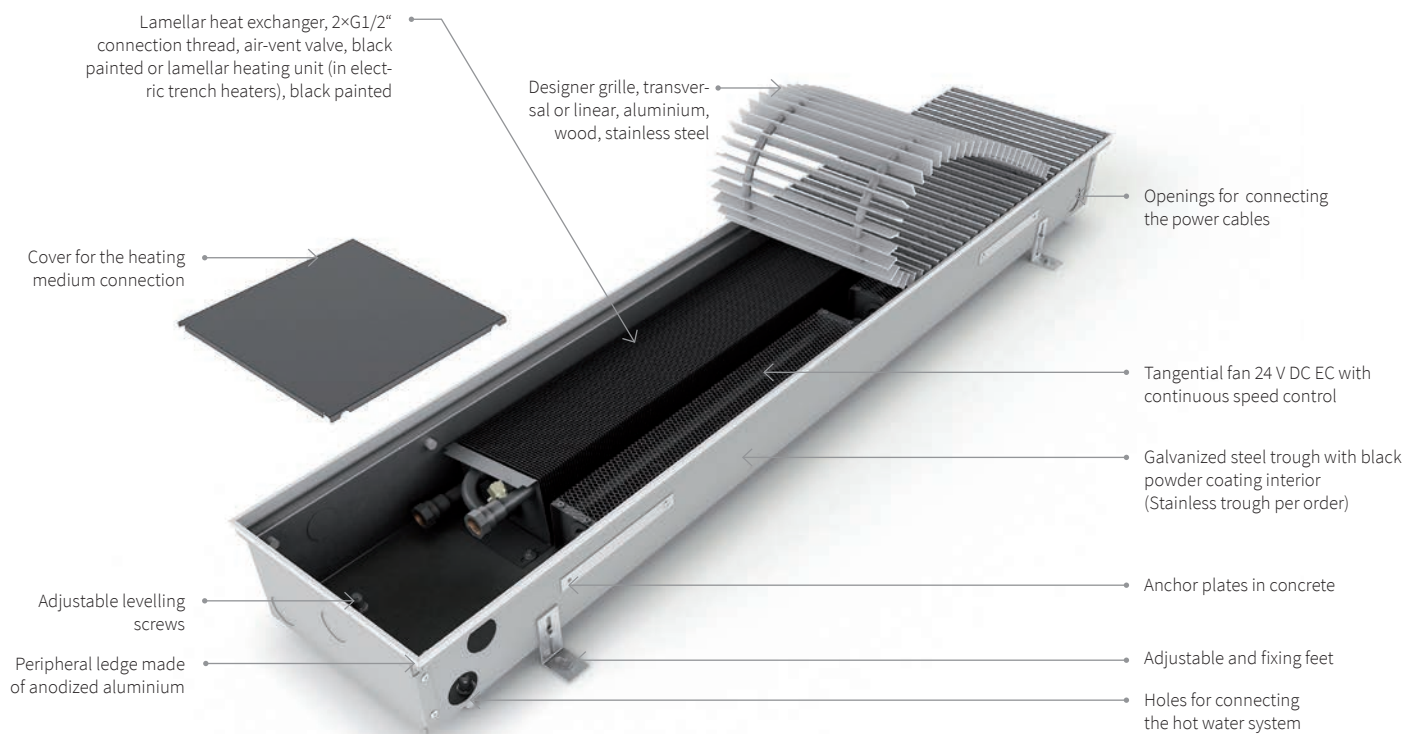

Note: FET and FEK electric trench heaters are also equipped with an electronic regulator to control the heating unit and the fan; see page 22 for more details.

Overview of TERMO trench heaters

Trench heaters with fan

FET

PURE ELECTRIC

Electric trench heater with a lamellar heating unit, fan and regulator, **heating**, dry environment

More details → page 24



FRT

FOR HEATING SYSTEM

Fan-assisted trench heater with **lamellar** heat exchanger, **heating**, dry environment

More details → page 34



FRB

FOR HEATING / COOLING SYSTEMS

Fan-assisted trench heater with **lamellar** heat exchanger, **heating**, humid environment

More details → page 94



FRC, FRD

FOR HEATING / COOLING SYSTEMS

Fan-assisted trench heater with **lamellar** heat exchanger, **heating and cooling**, dry environment

More details → page 86



Trench heaters with natural convection

FEK

PURE ELECTRIC

Fan-assisted trench heater with **lamellar** heat exchanger, **heating**, humid environment

More details → page 25



FRK

FOR HEATING SYSTEM

Trench heater with **lamellar** heat exchanger, **heating**, dry environment

More details → page 108



FRM

FOR HEATING SYSTEM

Trench heater with **lamellar** heat exchanger, heating, **humid environment**.

More details → page 124



Trench heaters with fan and installed power supply

FRZ

24 V DC power supply installed in FRT heaters, safe installation with IP67 electrical protection

More details → page 98



FZC, FZD

24 V DC power supply installed in FRC and FRD heaters, safe installation with IP67 electrical protection

More details → page 100



Atypical designs and modifications of trench heaters

Continuous, corner and cranked



Preset connection of trench heater



With anti-vibration foil

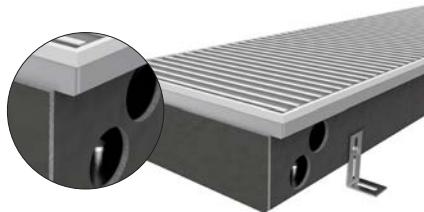

Conditioned air distribution around the trench heater

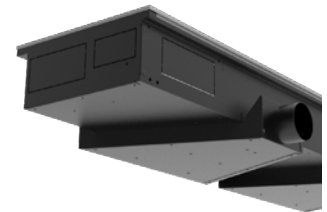

Conditioned air distribution through the floor unit



More details → page 10-13

Grilles

The lamellas in grilles are made of anodized aluminium. The surface is durable and resistant to abrasion and its colours are stable. The lamellas are supplied in the following colours: NATUR, BRONZE, BLACK and STAINLESS STEEL.

Aluminium low transverse grilles

For models FRT 0065 0175, FRT 0065 0200, FRT 0065 0250, FRT 0065 0300, FRT 0080 0175, FRT 0080 0200

The grille of the low trench heater type. It allows for installation into floor configuration with the heights of 65 and 80 mm. The aluminium lamellas are pressed into plastic longitudinal strips of black colour. The grille comes in 520 mm sections and an additional piece joined together at the installation site to form the required length.



NATUR - marking 15



BRONZE - marking 25



BLACK - marking 35

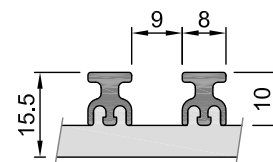

Grille's cross section

Low grilles can also be used for other types of convectors. Please, consult the ISAN Technical Department about this alternative.

Aluminium roll-up transverse grilles

Transverse lamellas are linked with a loaded spring and their limits are defined with distance rolls of hardened plastic. The rolling of the grille facilitates handling in the course of the installation and cleaning of the trench heater. The plastic rolls are assigned as follows based on the colour of the lamellas: NATUR – silver, BRONZE – black, BLACK – black. Aluminum grilles anodized to form a STAINLESS finish are fitted with stainless steel spacers. The lamellas may be provided with a surface finish of sprayed powder colour according to the RAL sample list.

Grilles suitable for electric trench heaters are marked with ⚡. These are non-roll grilles with a reduced distance between individual lamellas (as shown in the sectional view). Marking 17, 27, 37, 47.

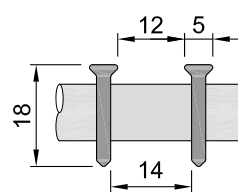

Grille's cross section

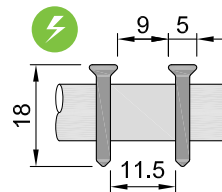

Grille's cross section

The maximal length of the grille in one piece is **6 500 mm**.

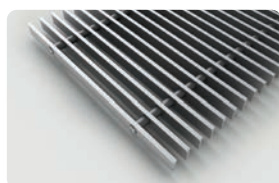

NATUR - marking 11

⚡ NATUR - marking 17



BRONZ - marking 21

⚡ BRONZ - marking 27

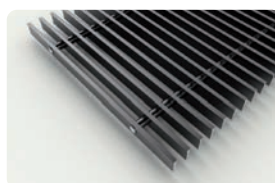

BLACK - marking 31

⚡ BLACK - marking 37

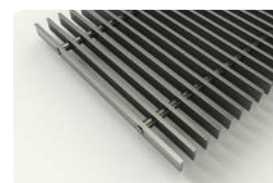

STAINLESS - marking 41

⚡ STAINLESS - marking 47

Note: the grilles cannot be used for trench heaters **FRT 0065 0175, FRT 0065 0200, FRT 0065 0250, FRT 0065 0300, FRT 0080 0175, FRT 0080 0200**.

Aluminium linear non-rolling grilles

Aluminium lamellas provided with holes along their length and joined with a steel supporting bar. The grille is divided into more pieces for easy handling. The span between the lamellas is defined by distance rolls of hardened plastic. The plastic rolls are assigned as follows based on the colour of the lamellas: NATUR – silver, BRONZE – black, BLACK – black. Aluminum grilles anodized to form a STAINLESS finish are fitted with stainless steel spacers. The lamellas may be provided with a surface finish of sprayed powder colour according to the RAL sample list.

The maximal length of a single piece is **3 000 mm**. Greater lengths can be achieved by linking more pieces together.

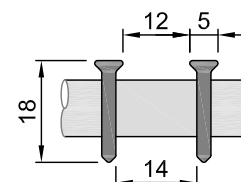

Grille's cross section



NATUR - marking 12



BRONZE - marking 22

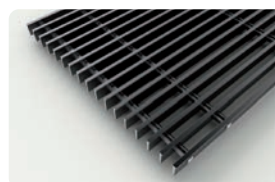

BLACK - marking 32



STAINLESS - marking 42

Note: the grilles cannot be used for trench heaters **FRT 0065 0175, FRT 0065 0200, FRT 0065 0250, FRT 0065 0300, FRT 0080 0175, FRT 0080 0200**.

Wooden roll-up grilles

The grilles are manufactured as a roll-up version, i.e. a transverse roll-up grille. The material used is beech and oak. It is possible to order grilles made of wood in natural state or of stained wood. The grilles are a suitable complement of interiors and can be harmonized with a wooden or floating floor. Additional surface modification may be used to increase the resistance and durability of the grille's material.

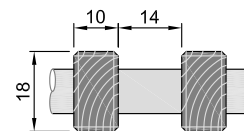

Grille's cross section

Surface finish NATUR – natural wood

Processed wood without an additional surface finish. The wood can be left in the raw state or provided with a surface finish to protect the wood. Based on the type of protection required and the external look (harmonizing with the interior) use staining, oil impregnation, waxing or varnish. The plastic rolls for the NATUR version are in black.



BEECH NATUR - marking 61



OAK NATUR - marking 63

Surface finish STAINED – stained wood

The wooden lamellas of the grille are stained with a penetrating dyestuff to secure a darker brown colour. This brings out the wood grain and provides a basic surface protection. The plastic rolls are in black.

The maximal length of the wooden grille in one piece is **6 500 mm**.



STAINED BEECH - marking 62



STAINED OAK - marking 64

Note: the grilles cannot be used for trench heaters **FRT 0065 0175, FRT 0065 0200, FRT 0065 0250, FRT 0065 0300, FRT 0080 0175, FRT 0080 0200**.

Transverse stainless steel grille

The grilles are made of 20 × 10 mm stainless steel profiles. This model features robust design, strength and rigidity. Individual grille lamellas have a brushed steel finish running lengthwise.

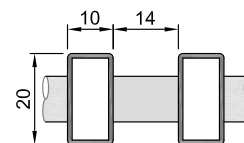

Grille's cross section

Car showroom

A fixed non roll-up grille with a rigid structure designed primarily for use in car showrooms. The grille lamellas are linked by steel rods and held apart by stainless steel spacers. A solid layer of concrete must be poured below the trench heater casing where the grille is to be placed.

The maximum length of 1 section of the stainless steel grille (51) is **2 000 mm**.

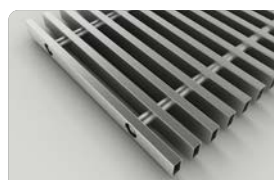

STAINLESS Car showroom - marking 51

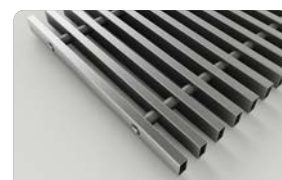

STAINLESS - marking 52

Design construction, roll up grilles

Interior design with spring-joined grille lamellas separated by grey hardened plastic spacers.

The maximum length of 1 section of the stainless steel grille (52) is **3 000 mm**.

Highly resistant grille

A special grille made of thick-walled stainless steel. Robust construction resistant to mechanical stress and wear. Ideal for installation in frequented areas (restaurants, cafés, entrance halls, business centers). Its rigid and compact design also ensures high resistance to concentrated loading (high heels). While the vents provide adequate air permeability, a 10% reduction in the trench heater output should still be expected.

The maximum length of one section is **1 000 mm**. The grille is composed of several sections of equal size to achieve the required length. The maximum width of the convector heater is **300 mm**.

Notes:

- The grilles are not suitable for convector heaters with a standard low grille: **FRT0065 0175, FRT 0065 0200, FRT 0065 0250, FRT 0065 0300, FRT 0080 0175, FRT 0080 0200**.
- grille is not suitable for heating / cooling trench heaters **FRC, FRD, FZC, FZD**



STAINLESS Solid - marking 95

Self-standing trench heaters

Its bottom supports make the trench heater a self-standing unit. The setting of the heating unit is final with no additional underlayment concrete required as with standard installations. The self-supporting components allow for height-adjustment in three positions: 0-35 mm, 10-70 mm and 60-300 mm. In this way, the trench heater can be installed in openings deeper than its height.

- › installation with the heater not resting on a firm base
- › the installation opening is deeper than the height of the planned trench heater unit
- › double floor structure (administrative buildings)

NOTICE:

- If this mounting option (self-standing) is selected, the heater acoustic parameters specified in the catalog cannot be guaranteed. Appropriate resonance absorption materials should be used.
- When using the self-standing supports, check the installation opening for adequate size to ensure that there is enough room to use the required tools.
- The specified self-standing types are suitable for the defined trench heaters. For any other types of trench heaters, please contact the ISAN Technical Department

Self-standing B

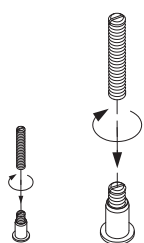

This type is compatible with FRK and FEK heating units only

In contrast with the standard design, this trench heater features more supporting screws located inside the heater casing. FRK trench heaters allow **0-35 mm** height adjustment.

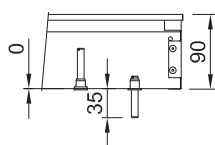

0-35 mm

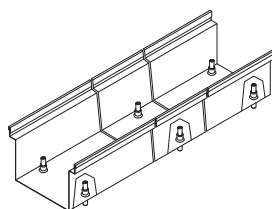

Heater with mounted legs

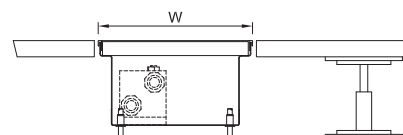

Installation view

Self-standing D

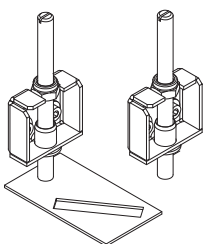

For trench heaters FRT, FRZ, FRC, FRD, FZC, FZD, FET, FRK, FEK

The trench heater is fitted with supporting legs and adjusting screws on the sides. The metal leg box is design for rough height adjustment, while the screw is used for fine tuning. Some legs come with a sheet metal base for attachment to the floor. Individual models have a different height adjustment range.

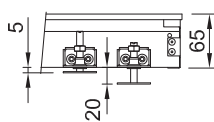

5-20 mm
FRT(FRZ) 0065

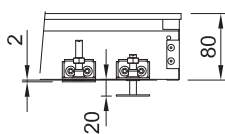

2-20 mm
FRT(FRZ) 0080, FRK 0080

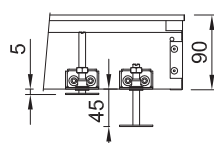

5-45 mm
FRT(FRZ) 0090, FRK 0090

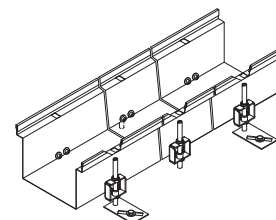

Heater with mounted legs

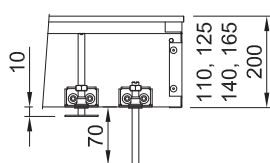

10-70 mm
FRT(FRZ) 0110, 0125, 0140, FET0110
FRK 0110, 0125, 0140, 0165, 0200, FEK 0140

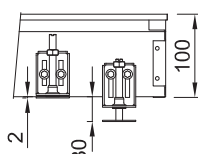

2-30 mm
FRC(FZC) 0100

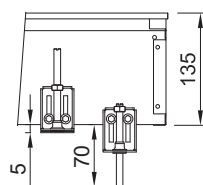

5-70 mm
FRC(FZC) 0135, FRD(FZD) 0135

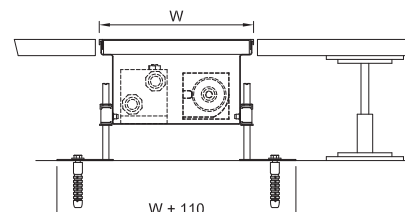

Installation view

Self-standing V

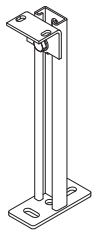

For trench heaters FRT, FRZ, FRC, FRD, FZC, FZD, FET, FRK, FEK

The trench heater is fitted with brackets and a metal box for mounting to the heater. The heating unit is set in the correct position by reducing the bracket height (following measurements at the installation site) and shifting the metal box attached to the heater body. Given the setting height of the heater, anchor the brackets firmly to the floor. The trench heaters allow **60-300 mm** height adjustment.

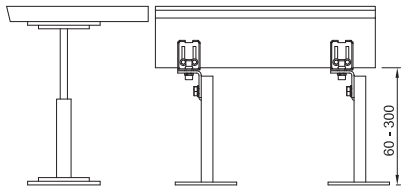

60 - 300 mm

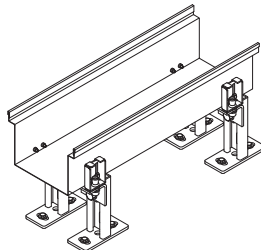

Heater with mounted legs

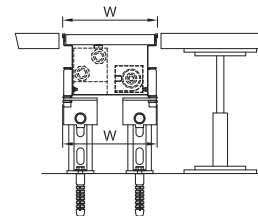

Installation view

Peripheral ledge

It forms the architectural and functional borders of the trench heater after its installation in the floor. The ledge of anodized aluminium is available in colours „NATUR“, „BRONZE“ and „BLACK“. The peripheral ledges may be provided with a surface finish of sprayed powder colour according to the RAL sample list. A trench heater without the peripheral ledge can be supplied for the hidden installation of the trench heater in the floor. In such case this should be written down in the form of a note (a different width of the grille)

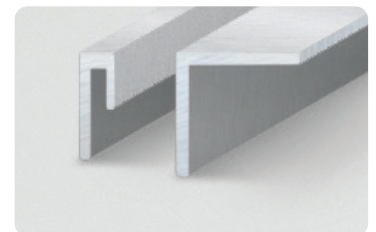

The ledge of anodized aluminium

Ledge „J“

A standard ledge that forms an architectural frame alongside the perimeter of the trench heater. Used for installation into floors that fit closely to the trench heater's body. Suitable for paving, architectural concrete, polished concrete floors, stone floors, lino, cork, ... The ledge is permanently installed during the manufacture of the trench heater.

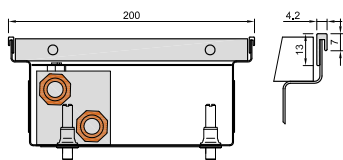

Peripheral ledge J-profile

Ledge „L“

A peripheral ledge with an overlap. The L cross section 15x15x1.5 enables the covering of the expansion gap with the width of up to 10 mm. The ledge is put besides the trench heater. It is installed after the final floor is completed. It is glued onto the inner edge of the trench heater. When installing the trench heater should be installed in a way so it does not exceed the level of the final floor. Suitable for wooden floors, plywood floors, laminate flooring, vinyl. It can be used in cases when the technology of the floor laying requires an expansion gap. The length and width of the trench heater is greater by 21 mm than the dimensions presented in the catalogue.

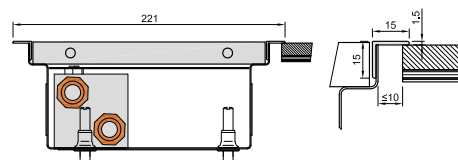

Peripheral ledge L-profile

Atypical trench heaters

Continuous, corner and cranked

Use broken-line trench heaters to cover heat losses from glassed-in surfaces copying irregular ground plans of rooms. We supply both acute and obtuse angles and multiple cranked trench heaters.

Continuous trench heaters comprising from multiple units can be installed in front of long glassed-in surfaces. The trench heater is equipped with a grille from one or multiple pieces which looks like a single long piece at the first sight. Specification of the trench heater location and approval of the design documentation by the customer are required before the start of the production.



Aluminium

transverse grilles
TYPE: 15, 25, 35

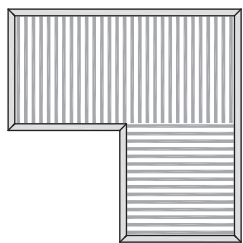

90° angle only

transverse roll-up grilles
TYPE: 11, 21, 31, 41

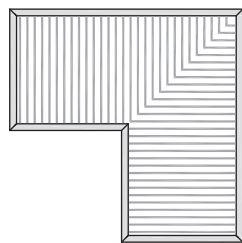

angle 40° - 320°

linear non-rolling grilles
TYPE: 12, 22, 32, 42

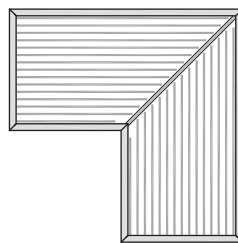

angle 40° - 320°

Wood

roll-up grilles
TYPE: 61, 62, 63, 64

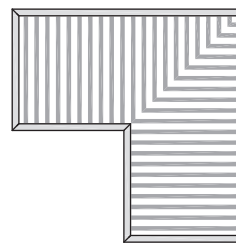

angle 40° - 320°

Stainless

roll-up grilles
TYPE: 51, 52

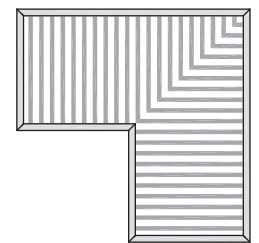

90° angle only

more about grilles on page 6

Examples

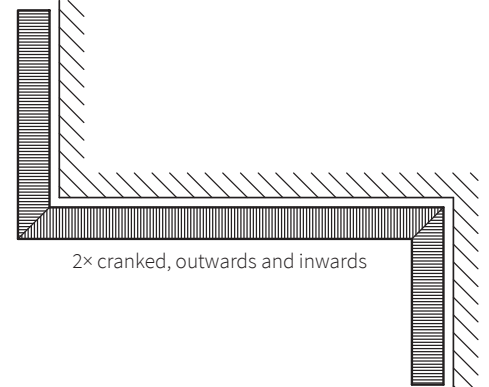
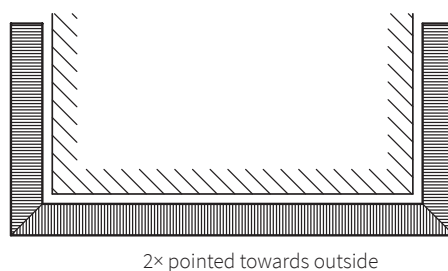
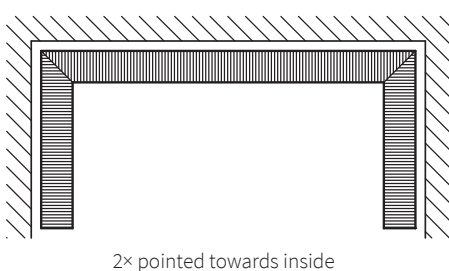
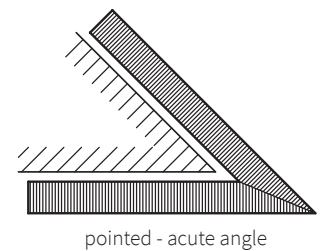
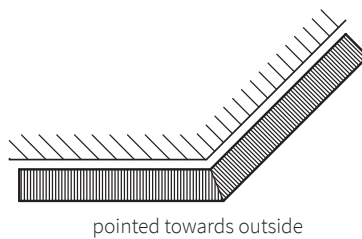
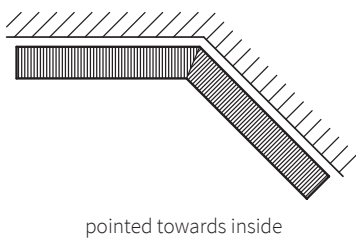
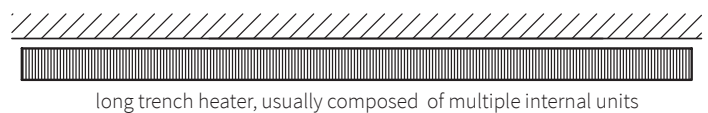
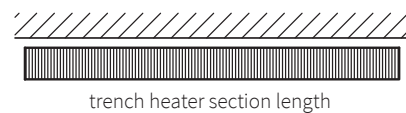

Arched

Modern structures with glassed-in arched sections can be equipped with rounded trench heaters. Windows are of arched or multiple broken-line shapes. The arch must follow the running line of the glassed-in surface. The trench heater's location must be measured at the construction site since the actual ground plan frequently differs from the design. Please consult this type of the trench heater in advance with the Technical Department of ISAN Radiatory s.r.o.



Examples

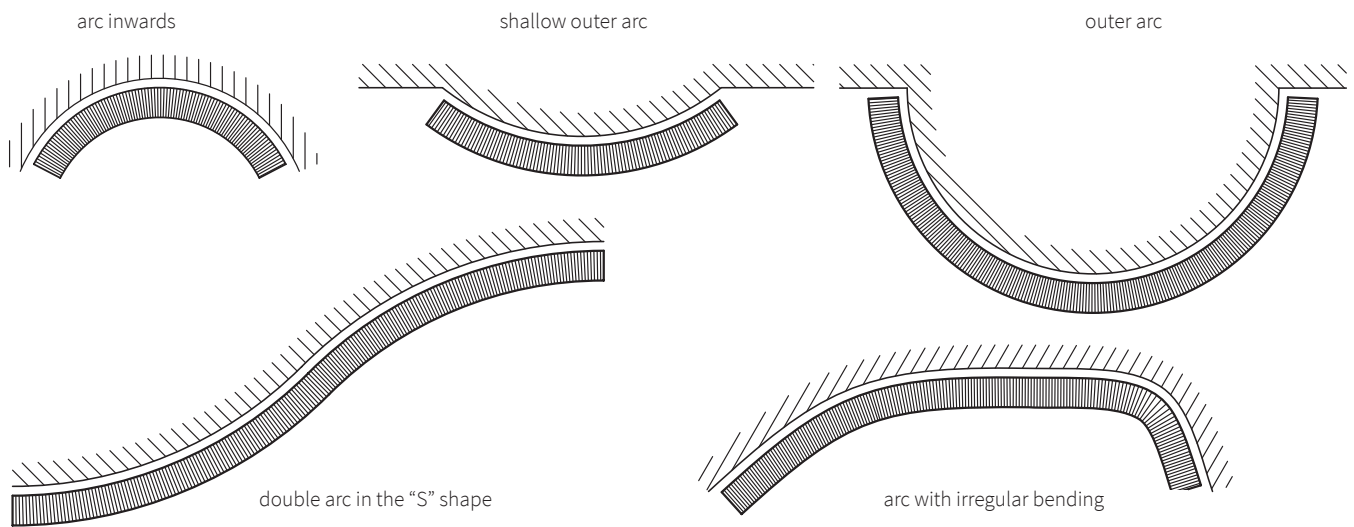

Cutouts in trench heaters

Trench heaters frequently intersect component parts of the structure, such as columns and partition walls. Columns may be fully incorporated in a trench heater or they can only interfere with it. A grille bypasses the column.

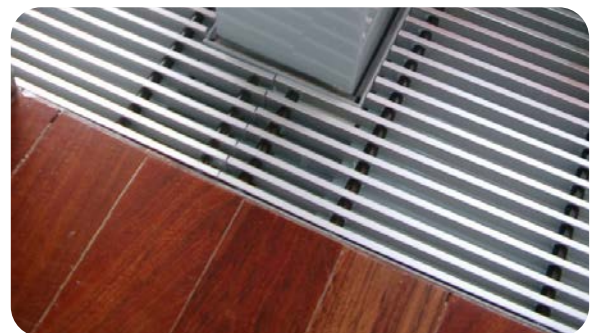
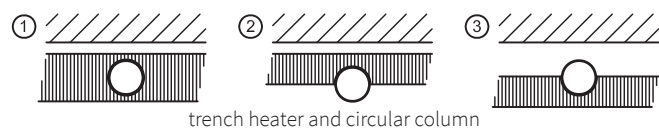
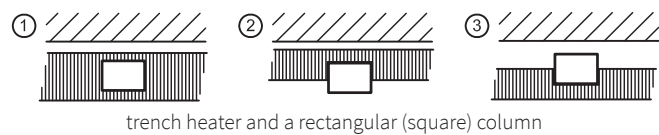

Atypical trench heaters

Preset connection of trench heater

Some projects, due to their scope, require special modifications to the trench heater. One of them is simplified connection of the trench heater, usually for the heating/cooling system, where, due to the number of inner fittings and interconnections, it is advantageous to have everything ready from manufacture. The heater includes thermostatic valves, reverse thread and electrothermal actuators. All of these are connected to the sideboard of the heater, pressure tested and ready for simple connection of heating system pipes. This connection is used in double floor structures, where it is permanently accessible. In some cases the fittings are located in the double floor interspace, with only the exchanger connection brought to the sideboard. A specific solution should be discussed with ISAN technicians to determine the suitability for individual heaters with regard to their dimensions and individual requirements on the elements installed.



Anti-vibration foil

Foam foil glued to the outside of the heater casing for vibration reduction

In standard floor installation, the trench heater is set in concrete or a solid layer of concrete is poured below the heater casing. The trench heater is fixed in place and anchored. In this case, no resonance sounds are generated during operation. However, self-standing models or taller models with natural convection are generally preferred in larger projects. The heaters are placed in a double floor structure as part of installations that often include dozens of units arranged along windows. These types of installations may produce pressure pulses caused by the natural expansion of the building itself or during normal operation. The convector metal casings can transmit the pulses in the form of vibrations or resonate with a particular sound.

We recommend installing an outer sheathing (anti-vibration foil) to suppress any unwanted vibrations produced by loosely placed floor convectors. The foil is attached to the outside of the metal casing of the floor unit. It covers the outer wall up to the bent edge of the casing along the entire length of the convector, including the sides. Only places where function elements are located are omitted. As the anti-vibration foil is factory-installed, this requirement must be noted in the order.

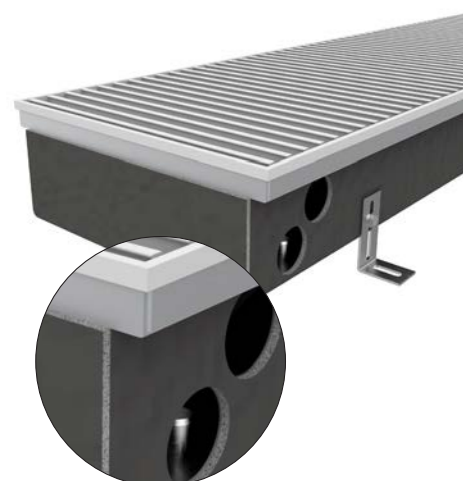

Conditioned air distribution through the floor unit

The sides of the heater casing can be provided with round or rectangular openings for air distribution. In standard installations, the conditioned external air is conducted without altering its properties. An application with air flowing through a heat exchanger usually requires a structural modification. This option must be consulted with ISAN.



Ø80-160 mm round openings with (or without) rim



30 × 400 mm to 80 × 600 mm rectangular openings with rim

Conditioned air distribution around the trench heater

Trench heaters equipped with an air bypass outlet are designed for use in buildings with central air conditioning. The trench heater has a heating or heating/cooling function, while the air conditioning unit facilitates the distribution of conditioned air from the ductwork into the room. This system requires double flooring to allow for installation of the trench heater connections, including the air duct. The volume of distributed fresh air is scaled in proportion to the number of people normally occupying the given space. The heater can be variably connected to multiple air conditioning units. The fresh air supplied by the air conditioning system combines with the heater output air to provide a comfortable indoor climate through a combination of heating, cooling and ventilation.

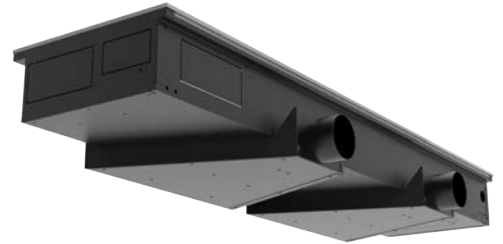

Fan-assisted trench heating acoustics

When planning fan-assisted trench heater installations for living quarters, it is essential that due consideration is given to both the trench heating acoustics and the environment in which the heater is to be installed. Trench heating units are very quiet, only emitting an audible humming sound when operated at maximum fan speeds. Individual heating units are incorporated into each project based on their output, dimensions, design and the required acoustic parameters. These requirements vary with the environment in which the installation is to take place, which includes residential areas, commercial establishments and public spaces.



Varying environment-based requirements

- › Entrance halls, hallways, waiting rooms, lobbies
- › Offices, administrative buildings
- › Living quarters, public buildings, car showrooms, shops
- › Spaces designed for rest and relaxation (living rooms, bedrooms)

Acoustic parameters in the catalogue

The trench heating acoustic parameters are determined in accordance with the EN 16430-1 standard. The parameter for determining the floor heater acoustics is its sound power level. Each fan-assisted product has a table listing these values. All measurements were conducted at an accredited testing facility in Brno in full compliance with EN ISO 9614-2: Acoustics – Determination of sound power levels of noise sources using sound intensity – Part 2: Measurement by scanning.

Description of acoustic parameters

In acoustics, there are two basic parameters: sound **power** and sound **pressure**. The unit determining sound parameters is the decibel [dB(A)].

The level of **sound power** is the total amount of propagated sound energy emitted by a source. It involves sound power propagation via sound waves. The **sound pressure** level is a measure of the effective pressure of a sound at a specific point in the room. It varies at different measurement

points and changes greatly (usually decreases) relative to the increasing distance of the source. The EN 16430-1 standard stipulates **sound power** as the primary acoustic parameter which we specify for each product.

Design

Product acoustic parameters constitute an important parameter with respect to trench heating dimensioning. The objective is both to reach the required heat output and to meet the specifications set out in the directive concerning health protection from adverse effects of noise and vibrations.

The project engineer factors in room acoustic parameters as well as the placement of the trench heater in the floor. An empty unfurnished room, which exacerbates the echo sound, will vary significantly, in terms of acoustics, from a room that has been furnished and equipped with sound attenuating elements. If the room furnishing is not known in advance, the least advantageous alternative should be considered. This is accomplished by choosing a more powerful heating unit that can be operated at lower speeds with quieter operation.

Installation of the trench heater inside the floor structure may present other challenges, such as noise and vibration transmission. The bottom part of the heater should therefore rest entirely on a solid support to prevent the reverberation of sound generated by the heater bottom. Where the heating unit comes in direct contact with hollow structures, appropriate sound absorbing transitional materials should be used.

Accessories TERMO

Controls and a power supply need to be added to trench heaters to secure their correct function. The temperature in the room is assessed by a room thermostat (RTD201, RTM201), which controls the fan's revs and the flow of heating medium through the heat exchanger. The flow is controlled via an electrothermal actuator (Z-TS24), which opens or closes a thermostatic valve (Z-TD001, Z-TE001, Z-LE001).

We install the thermostatic valve at the inlet of the heat exchanger. In order to adjust the flow of the heating medium it is necessary to install and set a screw joint (Z-RD001, Z-RE001) at the exchanger's outlet. The entire circuit functions on the basis of safe voltage of 24 V DC, which is provided by a power supply 24 V DC (PS-xx-24), which shall be sized according to the number of installed trench heaters.

Thermostats for trench heaters with fan



new

RTD201

DIGITAL ROOM THERMOSTAT

For controlling of trench heaters with fans 24 V DC EC and electrothermal actuators 24 V DC

Description

- › Digital room thermostat with backlit LCD display
- › 2 and 4 pipe heating/cooling circuits
- › Weekly scheduler
- › Manual or automatic switching of speeds
- › Operating modes: Comfort, Economy and Protection
- › Colour of front cover: white RAL9016

Parameters

- › Temperature range 5-40 °C (Comfort mode)
- › Rated voltage 24 V DC
- › Power consumption max. 4 VA
- › Control of fans 24 V DC EC 0...10 V DC EC, max. ±5 mA
- › Max. connecting of 10 pieces of electrothermal actuators Z-TS24
- › Degree of protection IP30
- › Ambient temperature 0-50 °C
- › Relative humidity <95%
- › Dimensions: 134×92×25 mm

Optional accessories

- › External temperature sensor TE40
- › Sensor of exchanger's temperature TE30
- › Possibility to connect open window sensor

Setting the thermostat

When putting into operation it is necessary to switch over the DIP switch and set the thermostat's internal parameters or use the PCT Go mobile app and set via NFC, see page 129 for more.



new

RTD201KN

KNX ROOM THERMOSTAT

A digital RTD201KN thermostat to facilitate trench heating integration into the BMS system.

Description

- › Digital room thermostat with backlit LCD display
- › 2 and 4 pipe heating/cooling circuits
- › KNX bus communication (S-mode and LTE-mode)
- › Manual or automatic switching of speeds
- › Operating modes: Comfort, Economy and Protection
- › Colour of front cover: white RAL9016

Parameters

- › Temperature range 5-40 °C (Comfort mode)
- › Rated voltage 24 V DC
- › Power consumption max. 4 VA
- › Control of fans 24 V DC EC 0...10 V DC EC, max. ±5 mA
- › Max. connecting of 10 pieces of electrothermal actuators Z-TS24
- › Degree of protection IP30
- › Ambient temperature 0-50 °C
- › Relative humidity <95%
- › Dimensions: 134×92×25 mm

BMS integration

- › putting it into operation
 - › ETS5 or higher versions
 - › ACS version 13.03 or higher
- › integrated with Synco controllers
- › integrated into the DESIGO system via group (ETS) or individual addresses
- › integrated into external systems via group addresses (ETS)

Optional accessories

- › External temperature sensor TE40
- › Possibility to connect open window sensor



RTM201

ROOM THERMOSTAT

A mechanical thermostat for 3-stage control of trench heaters fitted with 24 V DC EC fans and 24 V DC electrothermal actuators.

Description

- › mechanical thermostat for trench heating control
- › 2-pipe heating/cooling system
- › manual 3-speed fan switch
- › front cover color - RAL9003 White

Parameters

- › Temperature range 8...30°C
- › Rated voltage 24 V DC
- › Input: 2mA (without external loading)
- › 24 V DC EC fan control, max. 10 mA
- › Max. connecting of 4 pieces of electrothermal actuators Z-TS24
- › fan operation blocking in the event of low heating medium temperature
- › anti-freeze protection
- › IP30 protection rating
- › Ambient temperature 0-50 °C
- › Relative humidity <95%
- › Dimensions: 110×96×36 mm

Optional accessories

- › Sensor of exchanger's temperature TE30

* The heat-transfer circuit must be in operation in order for this function to work properly.

Controls and possibly a power supply need to be added to trench heaters to secure their correct function. The temperature in the room is assessed by a special thermostat (RTD301, Z-RT001, Z-TF001), which controls the flow of heating medium through the exchanger. The thermostat Z-RT001 controls the flow via an electrothermal actuator (Z-TS24, Z-TS230), which opens or closes a thermostatic valve (Z-TD001, Z-TE001, Z-LE001) in the opened/closed mode. The thermostat Z-TF001 controls the thermostatic valve continuously without the need to connect it to a power supply. We install the thermostatic valve at the inlet into the exchanger.

In order to adjust the flow of the heating medium it is necessary to install and set a lockshield valve (Z-RD001, Z-RE001) at the exchanger's outlet. The entire circuit functions on the basis of safe voltage of 24 V DC, which is provided by a switched power supply 24 V DC (PS-xx-24). This type of connection will especially be used in rooms with the combination of trench heaters with a fan and trench heaters without a fan – this all is connected to thermostat RTD201. The second option is the connection of Z-TS230 without the use of a power source – only for rooms with trench heaters without fans.

Thermostats for trench heaters with natural convection



RTD301

PROGRAMMABLE ROOM TEMPERATURE THERMOSTAT

The thermostat controls heat-transfer fluid flow through natural convection trench heaters. It works in combination with Z-TS230 electrothermal actuators activated based on a time schedule adjustable to 15-minute intervals.

Description

- › 2 position ON/OFF heating control
- › Weekly time schedule
- › Operating modes: Comfort, Standby, Automatic and Protection
- › Front cover color - RAL9003 White

Parameters

- › Temperature range: 5-35 °C
- › Supply voltage: 3 V DC (2x 1.5 V batteries)
- › Switching voltage: 24 ... 230 V AC
- › Connectable to up to 15 pcs Z-TS24 electrothermal actuators
- › Degree of protection IP30
- › Ambient temperature 0-50 °C
- › Relative humidity <95%
- › Dimensions: 127×85×22 mm

Optional accessories

- › External TE40 temperature sensor
- › Optional open-window sensor



Z-RT001

ROOM THERMOSTAT FOR FLOW CONTROL IN TRENCH HEATERS WITHOUT FAN

It controls electrothermal actuators Z-TS24 with a switched power supply 24 V DC (PS). Without the power supply it directly controls the electrothermal actuator Z-TS230 working with the voltage of 230 V AC. Function opened/closed.

Parameters

- › Temperature range: 10 to 30 °C
- › Operating voltage: 24 V DC or 230 V AC
- › The number of controlled electrothermal actuators:
- › 24 V DC - 10×Z-TS24
- › 230 V AC - 30×Z-TS230
- › Protection: IP30
- › Colour: white
- › Dimension: 83×83×40 mm



Z-TF001

ROOM THERMOSTAT WITH A THERMOSTATIC HEAD WITH A CAPILLARY

The thermostatic head Z-TF001 with remote control with a liquid sensor is meant for the control of thermostatic valves of FRK trench heaters. The temperature is regulated in dependence on the user's requirements without the need for other energy sources. Each trench heater must have its own Z-TF001, more trench heaters cannot be controlled!

Parameters

- › Thermostatic radiator valve head with remote liquid-filled sensing element
- › Temperature range: 9 to 26 °C, antifreeze temperature 9°C
- › Mode: proportional control
- › Operating temperature: without additional energy, liquid-filled sensing
- › Capillara tube length: 5 m
- › Body-head connection: M30×1,5 mm
- › Dimension: 75×75 mm, sensor ø 50×68 mm
- › Colour: white to RAL 9010



The accessories are also suitable for electric trench heaters.

Accessories TERMO

PS-60-24 / PS-100-24 / PS-240-24 / PS-480-24 POWER SUPPLY

Converts the mains voltage of 230 V AC to safe voltage of 24 V DC, power supply made ready for installation on DIN bar.

Description

- › For the placement of the source provide sufficient space in the switchboard
- › Size the output to fit the input of installed bodies and cabling, provide 5% output reserve on the source against calculated consumption
- › PS-60-24 and PS-100-24 may be installed in a box for wall installation



PS-60-24, 60 W
24 V DC, 52,5 × 90 × 54,5 mm



PS-100-24, 100 W
24 V DC, 70 × 90 × 54,5 mm



PS-240-24, 240 W
24 V DC, 63 × 153 × 114 mm



PS-480-24, 480 W
24 V DC, 86 × 153 × 129 mm

Z-TS24 / Z-TS24A / Z-TS24-5m Z-TS230/Z-TS230-5m

ELECTROTHERMAL ACTUATOR 24 V DC

ELECTROTHERMAL ACTUATOR 230 V AC

Opened/closed function (without voltage closed).

Parameters

- › Operating voltage: 24 V DC
- › Max. inrush current <300 mA during max. 2 min.
- › Operating power: 1 W
- › Opening/closing time: 210 s
- › Type of protection: IP54, in all installation positions
- › Stroke: 4 mm
- › Connection to valve: M30×1,5 mm (adapter)
- › Colour of actuator and cable : black
- › Adapter is a part of actuator
- › **Z-TS24** cable length 3 m
- › **Z-TS24A** without cable, intended for FRC 0100 0175, where the cable is already installed in the trench heater
- › **Z-TS24-5m** cable length 5 m

Opened/closed function (without voltage closed).

Parameters

- › Operating voltage: 230 V AC, +10 ... -10 %, 50/60 Hz
- › Max. inrush current <550 mA during max. 100 ms
- › Operating power: 1 W
- › Opening/closing time: 210 s
- › Stroke: 4 mm
- › Protection class: II
- › Type of protection: IP54, in all installation positions
- › Connection to valve: M30×1,5 mm (adapter)
- › Colour of actuator and cable : black
- › Adapter is a part of actuator
- › **Z-TS230** cable length 3 m
- › **Z-TS230-5m** cable length 5 m

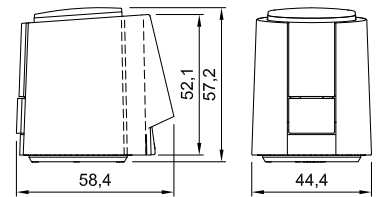

Z-RD001 / Z-RE001 LOCKSHIELD VALVE DIRECT AND CORNER

Direct and corner closing and regulation screw connection, flow setting, installation on the exchanger's outlet pipe.

Parameters

- › Size: DN15
- › Value kvs
- › direct 0.30-1.80
- › corner 0.30-3.00
- › Max. operating temperature: 110 °C
- › Max. operating overpressure: 10 bar



Z-RD001
direct screw connection



Z-RE001
corner screw connection

T - Speed	0,5	0,75	1	1,5	2	2,5	3	3,5	4	5	6	Max.
Kv (m³/h) - direct type	0,3	0,4	0,55	0,75	0,91	1,05	1,25	1,33	1,4	1,6	1,7	1,8
Kv (m³/h) - corner type	0,2	0,25	0,29	0,4	0,5	0,69	0,8	1	1,2	1,55	1,9	2,2

Z-TD001 / Z-TE001 / Z-LE001 THERMOSTATIC VALVE DIRECT, CORNER AND AXIALCORNER

Direct, corner and axial thermostatic valve, heating medium flow regulation in the system, installation on the heat exchanger's inlet pipe.

Parameters

- > Size: DN15, NF standard
- > Connecting thread: M30×1,5 mm
- > Max. operating temperature 120 °C
- > Max. operating pressure PN10
- > Option to change pre-setting of kv-value
- > kv value (m3/h) range 0.10-0.89

Parameters Z-LE001 (for FRC 0100 0175)

- > Connecting thread: M30×1,5 mm
- > Max. operating temperature 130 °C
- > Max. operating pressure PN10
- > Option to change pre-setting of kv-value
- > kvs value 0,70



Z-TD001
direct thermostatic valve



Z-TE001
corner thermostatic valve



Z-LE001
horizontal axial valve

Flow diagrams for thermostatic valves are shown on page 128

PR40, PR50 EXTENSION PIECE WITH ELBOWS FOR FRT, FRB, FRZ, FRK, FRM

For easy connection of the trench heater to the heating system in the direction towards the room centre. The length of the extension piece and the types of elbows will set the connection points opposite the openings in the trench heater's trough.

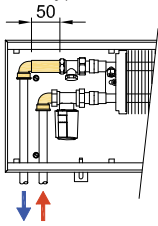

PR50 extension piece 50 mm, 2×elbow 90°
Suitable for models:
0065 0175, 0065 0200, 0065 0250 0065 0300,
0080 0250, 0080 0300, 0080 0425

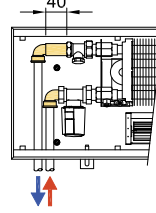

PR40 – extension piece 40 mm, 2×elbow 90°
All other models FRT, FRK,
except for the ones
stated with PR50

Connection packs FOR FRT, FRB, FRZ, FRK AND FRM TRENCH HEATERS

Connection packs for easy front or side connection with time-tested valves and fittings. Each pack includes a thermostatic valve, installed at the inlet of the lamellar heat exchanger, an electrothermal actuator for flow control, return and control fittings for hydraulic resistance setting and, if required, an extension piece with elbows.

Connection to the room

Pack No.	Connection drawing	Trench heater type	Trench heater length	Flow control	Thermostatic valve	LockShield valve	Connection pack:
NP1		FRT, FRB, FRZ, FRK, FRM	< 2900 mm	Z-TS24	Z-TD001 direct	Z-RD001 direct	Extension piece: 40 and 50 mm
NP2		FRT, FRB, FRZ, FRK, FRM	≥ 2900 mm	Z-TS24-5m			
NP3		FRK, FRM	all	Z-TS230			Elbow: 2× 90°
NP5		FRK, FRM	all	Z-TF001			

Side connection

Pack No.	Connection drawing	Trench heater type	Trench heater length	Flow control	Thermostatic valve	LockShield valve	Connection pack:
NP11		FRT, FRB, FRZ, FRK, FRM	< 2900 mm	Z-TS24	Z-TD001 direct	Z-RD001 direct	is not
NP12		FRT, FRB, FRZ, FRK, FRM	≥ 2900 mm	Z-TS24-5m			
NP13		FRK, FRM	all	Z-TS230			
NP15		FRK, FRM	all	Z-TF001			

Accessories TERMO

DF10 FAN INTAKE FILTER FOR FRC, FRD, FZC AND FZD HEATERS

Parameters

- › Available only for models of dimension 135 × 325 mm
- › Colour: black
- › Filter dimensions: please mention in the order the length of the convector (e.g. DF10 for FRC 135x325, l=2000 mm)



CP10 CONDENSATE DIAPHRAGM PUMP FOR FRC, FRD, FZC AND FZD HEATERS

A membrane pump of condensate that may occur at cooling, connection to the convector drain pipe

Parameters

- › Operation voltage: 230 V/50 Hz
- › Power input: 16 W / 0.17 A
- › Max. recommended delivery: 10 m
- › Capacity l/h: 12 l (0 m) – 4.5 l (10 m)
- › Acoustic pressure at delivery of 1m: 21 dB(A)
- › Voltage-free contact - alarm: 3 A induction, contacts N.O., N.C.



RL10 RELAY

The thermostat RTD201 allows for the connection of 10 pieces of electrothermal actuators at most, if the number of installed actuators is higher use RL10 according to the electric scheme.

Parameters

- › Voltage in winding: 24 V DC
- › Degree of protection: IP20
- › Max. switching current: 12 A
- › Without voltage: disconnection
- › 37×20×39 mm
- › Max. operating temperature: 60 °C



KP10 BOX FOR POWER SUPPLY

Box to place under plaster, for the installation of the power supply.

Parameters

- › Option of installation of PS-60-24 and PS-100-24
- › Attachment to DIN bar
- › Installation under plaster, hidden in the wall
- › 234×176×79 mm
- › For the case when more supplies need to be installed
- › When the space in the switchboard is not sufficient



TE30 SEPARATED TEMPERATURE SENSOR / for thermostat RTD201 and RTM201

Parameters

Heating

a separate temperature sensor monitors the heat exchanger temperature, ensuring the fans are not activated while the heat exchanger is cool

Heating / cooling

automatic switching between heating/cooling modes

- › Connection to thermostat RTD201, RTM201
- › Measuring sensor NTC, 3 k Ω at 25 °C
- › Measuring accuracy at 25 °C: ± 0.3 K
- › Cable length ca. 2.5 m, can be adjusted, max. total length 80 m
- › Temperature range 5-40°C



TE40 EXTERNAL SPATIAL SENSOR FOR TEMPERATURE / for thermostat RTD201

Parameters

- › Measures room temperature on a different spot than the spot where the thermostat is installed
- › Connection to thermostat RTD201
- › Measuring range 0-40 °C
- › Measuring sensor NTC, 3 k Ω at 25 °C
- › Measuring accuracy at 25 °C: ± 0.3 K
- › Degree of protection IP30
- › Operating temperature 0-50 °C
- › Relative humidity <85 %
- › White colour RAL9003
- › 97×100×36mm



 The accessories are also suitable for electric trench heaters.

FET, FEK

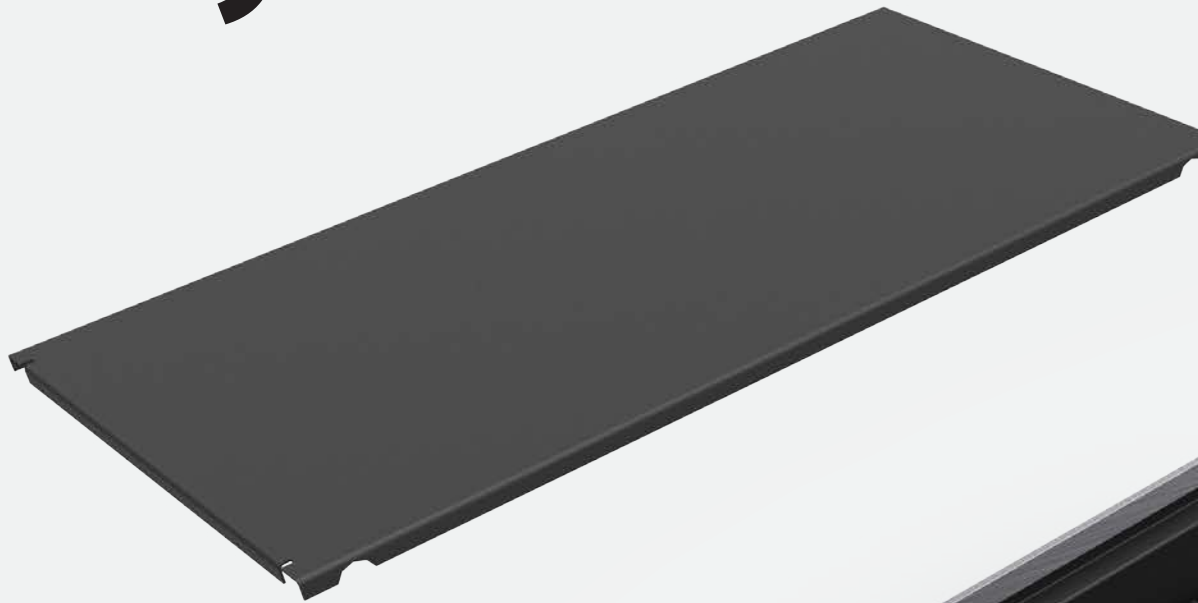



electric trench heater
**with an electric heating unit,
heating**

TERMO

electric trench heaters



Features

- › optimum heat outputs
- › all electric
- › no heating system connection required
- › continuous output regulation
- › safety features
- › electronic regulator
- › 24 V DC EC tangential fans
- › 4 grille designs

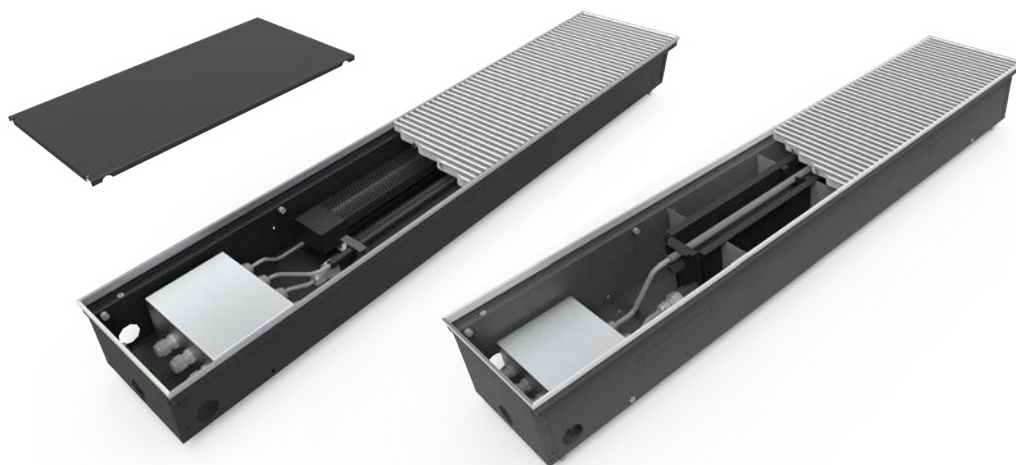

Electric trench heaters are normally installed directly in front of large glass surfaces. The advantage of electric-only heaters lies in their independence of forced-circulation heating systems. The heat output produced by trench heaters is sufficient to be used either as the primary or secondary heat source. They make a perfect fit in the existing building space, in contemporary low-energy and passive homes, in electric-only houses, in buildings under construction and wherever connection to the heating system is not possible or desirable.

The family of electric trench heaters includes the **FEK** model with natural convection and a fan-operated **FET** model. The trench heater includes a

built-in electric heating unit controlled by an electronic regulator. Forced convection models feature a tangential ventilator with cylindrical rotors, designed to force air into the ribbed heating unit. This allows for more than doubling the heat output without any increase in size. The heaters utilize efficient EC motors supplied with safe 24 V DC voltage. The motors have very low power consumption. The fan speed is continuously regulated by a control voltage in the range from 0 to 10 V DC.

Function

The trench heater is controlled via a room thermostat or 0-10 V DC higher-level regulation. The room thermostat ensures correct functioning, adjusts the difference between the preset and actual room temperature, activates the heating unit and regulates the fan speed based on the temperature difference and the set operation mode.

Operation of the heater is regulated by an electronic power controller located in each unit. The output of the heater (both the heating unit and the fan) is smoothly regulated ensuring that any changes in room temperature are continuously monitored and adjusted. This in turn significantly increases the room's thermal comfort. The same applies when using an appropriate control device such as the RTD201 digital thermostat.

Safety

The power electronics are placed in an IP44 aluminium box connected to the heating unit with the same degree of protection. The fan is powered by safe 24 V DC voltage.

The electronics feature a multi-stage function control, including sensors installed above the heat exchanger. The regulating mechanism responds promptly to any changes in conditions if it detects a deviation from normal operation. Especially if the heater is accidentally covered by a rug or if the free air flow through the grille is otherwise impeded, it immediately switches the unit into a stand-by mode or shuts the heater down. The designer grille is securely fixed to the unit and cannot be removed without the appropriate tool.

Heat and safety sensors monitor the output temperature from the trench heater. The grille temperature will not exceed 45 K above the ambient temperature. (in accordance with EN 603335-1 and 603335-2-30).

The range of electric trench heaters

Electric trench heater with fan	Electric trench heater with natural convection
<p>FET</p> <ul style="list-style-type: none"> > heating > tangential fan > lamellar electric heating unit > dry environment > page 24 	<p>FEK</p> <ul style="list-style-type: none"> > heating > lamellar electric heating unit > dry environment > page 25

Overview of FET, FEK electric trench heaters

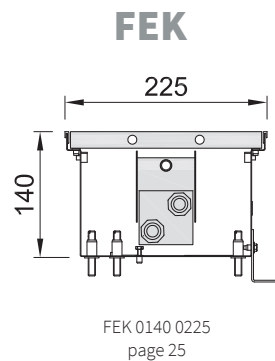
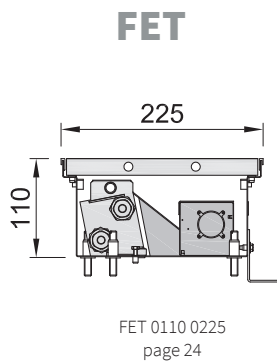

Placement in the floor

The trench heaters are laid in the floor so that the heat exchanger is closer to the window side, while fans are placed deeper into the room. The vertical and horizontal distribution of temperatures in the heated room is uniform and conditions are created to provide thermal comfort.

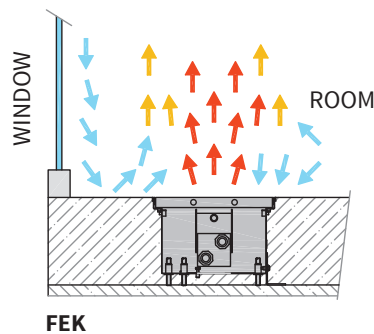
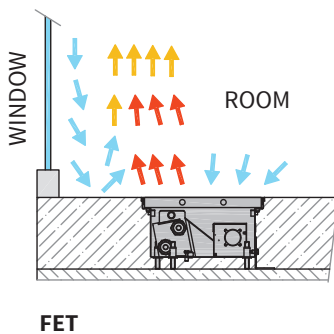

Heating function

- > Air becomes heated by flowing through the heat exchanger
- > Warm air is mixed with cool air running down the window surfaces
- > Air circulation:
 - Heating air in the room
 - Screening out window surfaces
 - Secondarily demisting window surfaces

Operating conditions

- > Rated voltage of the heater: 230 V AC, 50/60 Hz
- > Rated voltage of the heating unit: 230 V AC, 50/60 Hz
- > Rated voltage of the fan: 24 V DC (EC motor with continuous speed regulation)
- > Protection rating of the heater: IP20, use in dry environments
- > Ambient conditions: Ambient temperature +2 - 40°C; Relative humidity 20 - 70%

FET 0110 0225

FAN-ASSISTED ELECTRIC TRENCH HEATER



- > glass-walled rooms
- > high performance of the heating unit in combination with the fan
- > operation independent of the central heating system
- > continuous speed regulation, silent operation
- > safe 24 V DC fan voltage
- > 230 V AC / 50 Hz heating unit
- > cable connection to IP44 control regulation
- > safety sensors along the entire length of the heating unit

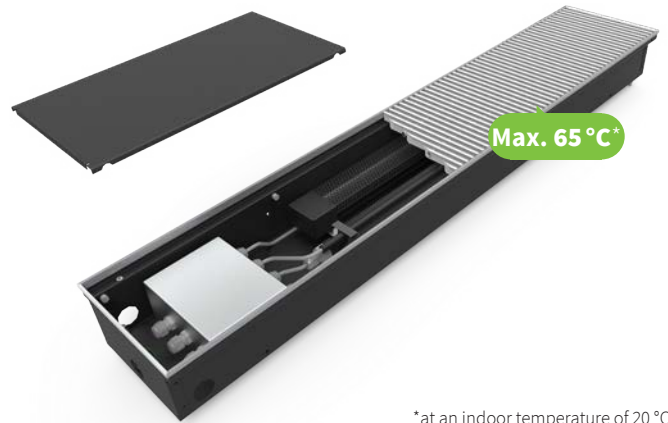

* at an indoor temperature of 20 °C

Technical data

Trench heater

Height [H]	110 mm
Width [W]	225 mm
Length [L]	800-2 000 mm in step 400 mm

Heating unit

Type	Al-Cu type with a heating element
Length	L-410 mm

Operating conditions

Protection	IP 20
Control unit and connection cabling protection	IP 44
Ambient conditions	Temp. T = +2 to +40 °C Humidity RH = 20 to 70%

Trench heater standard equipment

Trough	Galvanized steel trough with surface finish and black spray layer inside, black cover plates of connection
Heating unit	Heating unit with aluminium ribs and tubing, including temperature and safety sensors, black coating
Grille	Design walkable grille according the customer's choice (stainless grilles surcharge)
Ledge	Made of anodized aluminium, type and colour according the customer's choice
Fan	Modern tangential fan with 24 V DC EC motor with high efficiency, rotors protection
Assembly elements	Leveling screws for setting up the trough, mounting brackets
Manual	Manual for the progress of work during installation and user manual
Wiring	Electrical wiring diagram of the trench heaters
Mounting board	Cover and the spacer particle board for easy installation
Package	Transport package for protection against damage during transportation and handling

Safety

- > Rigid non-roll grille is secured to the trench heater casing - child-tamper resistant
- > The surface temperature of the grille does not normally exceed 65°C - in accordance with EN 60335-1 and EN 6035-2-30
- > Safety features designed to reduce the output temperature if the grille gets accidentally covered - multiple electronic protection to ensure safety of operation

Technical drawing

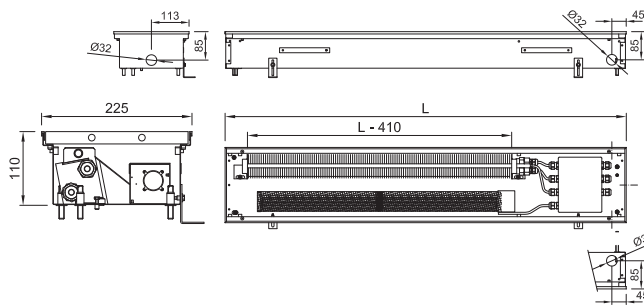

Wiring preview

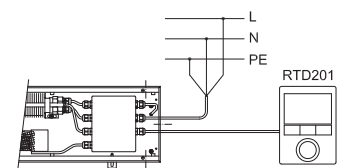

Controls

Room thermostat



Digital room thermostat



Room thermostat

Variants

Grilles

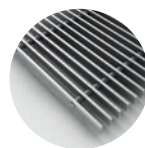

Rigid

Peripheral ledge

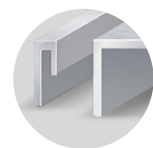

- ① Grilles → 6
② Ledges → 8
③ Acoustic power → 13
④ Accessories → 14
⑤ Wiring parameters → 126
⑥ Wiring → 129

Code example: FET 0110 0225 1600 C 37 J3 R - 6

Trench heater **FET** H = 110 mm, W = 225 mm, L = 1 600 mm, „**C**“ Galvanized steel trough with black inside, heat exchanger and inner parts painted black, „**37**“ black anodized aluminium grille, transverse, rigid „**J3**“ peripheral ledge „**J**“, black anodized aluminium, „**R**“ right-side power connection (with the heating unit installed closer to the window and fans on the room side) „**6**“ 24 V DC fans + installed control unit

FEK 0140 0225

NATURAL CONVECTION ELECTRIC TRENCH HEATER



- > glass-walled rooms
- > high performance of the heating unit
- > operation independent of the central heating system
- > silent operation
- > 230 V AC / 50 Hz heating unit
- > cable connection to IP44 control regulation
- > safety sensors along the entire length of the heating unit

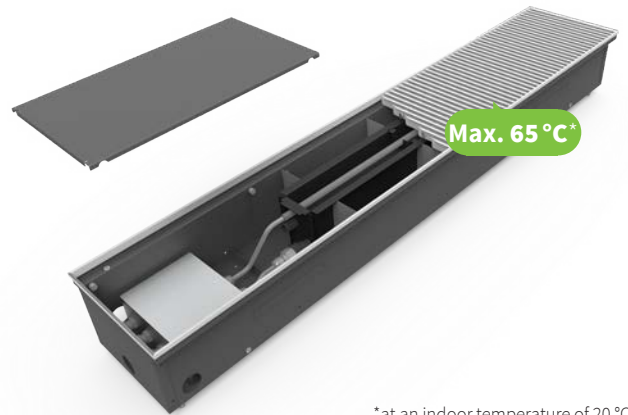

* at an indoor temperature of 20 °C

Technical data

Trench heater

Height [H]	140 mm
Width [W]	225 mm
Length [L]	800-2 000 mm in step 400 mm

Heating unit

Type	Al-Cu type with a heating element
Length	L-410 mm

Operating conditions

Protection	IP 20
Control unit and connection cabling protection	IP 44
Ambient conditions	Temp. T = +2 to +40 °C Humidity RH = 20 to 70%

Trench heater standard equipment

Trough	Galvanized steel trough with surface finish and black spray layer inside, black cover plates of connection
Heating unit	Heating unit with aluminium ribs and tubing, including temperature and safety sensors, black coating
Grille	Design walkable grille according to the customer's choice (stainless grilles surcharge)
Ledge	Made of anodized aluminium, type and colour according to the customer's choice
Assembly elements	Leveling screws for setting up the trough, mounting brackets
Manual	Manual for the progress of work during installation and user manual
Wiring	Electrical wiring diagram of the trench heaters
Mounting board	Cover and the spacer particle board for easy installation
Package	Transport package for protection against damage during transportation and handling

Safety

- > Rigid non-roll grille is secured to the trench heater casing - child-tamper resistant
- > The surface temperature of the grille does not normally exceed 65°C - in accordance with EN 60335-1 and EN 6035-2-30
- > Safety features designed to reduce the output temperature if the grille gets accidentally covered - multiple electronic protection to ensure safety of operation

Technical drawing

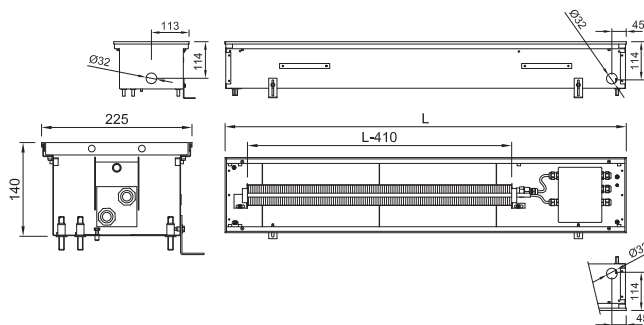

Wiring preview

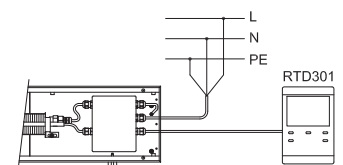

Controls

Room thermostat



Digital room thermostat



Room thermostat

Variants

Grilles

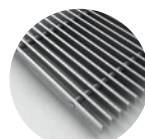

Rigid

Peripheral ledge

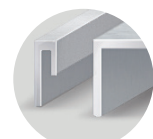

- ⓘ Grilles → 6
 Ⓜ Ledges → 8
 ⊕ Accessories → 14
 Ⓜ Wiring → 27

Code example: FEK 0140 0225 1200 C 17 J1 R - 1

Trench heater FEK H = 140 mm, W = 225 mm, L = 1 200 mm, „C“ Galvanized steel trough with black inside, heat exchanger and inner parts painted black, „17“ natural anodized aluminium grille, transverse, rigid „J1“ peripheral ledge „J“, natur anodized aluminium, „R“ right-side power connection, „1“ installed control unit

FET, FEK – outputs and acoustic parameters

Technical data



Heating output FET 0110 0225

Length L [mm]	Speed [-] / Heating output [W]		
	minimum	medium	maximum
800	90 W	340 W	550 W
1200	165 W	620 W	1 000 W
1600	260 W	990 W	1 600 W
2000	360 W	1 360 W	2 200 W

Heating output can be continuously controlled with 0 ... 10 V DC



Heating output FEK 0140 0225

Length L [mm]	Heating output [W]
	maximum
800	250 W
1200	500 W
1600	750 W
2000	1 000 W

Heating output can be continuously controlled with 0 ... 10 V DC



Acoustic power [dB(A)]

Length L [mm]	Speed [-] / Acoustic power [dB(A)]		
	minimum	medium	maximum
800	< 25 dB(A)	26 dB(A)	29 dB(A)
1200	< 25 dB(A)	27 dB(A)	30 dB(A)
1600	< 25 dB(A)	29 dB(A)	33 dB(A)
2000	< 25 dB(A)	30 dB(A)	34 dB(A)

Trench heater design

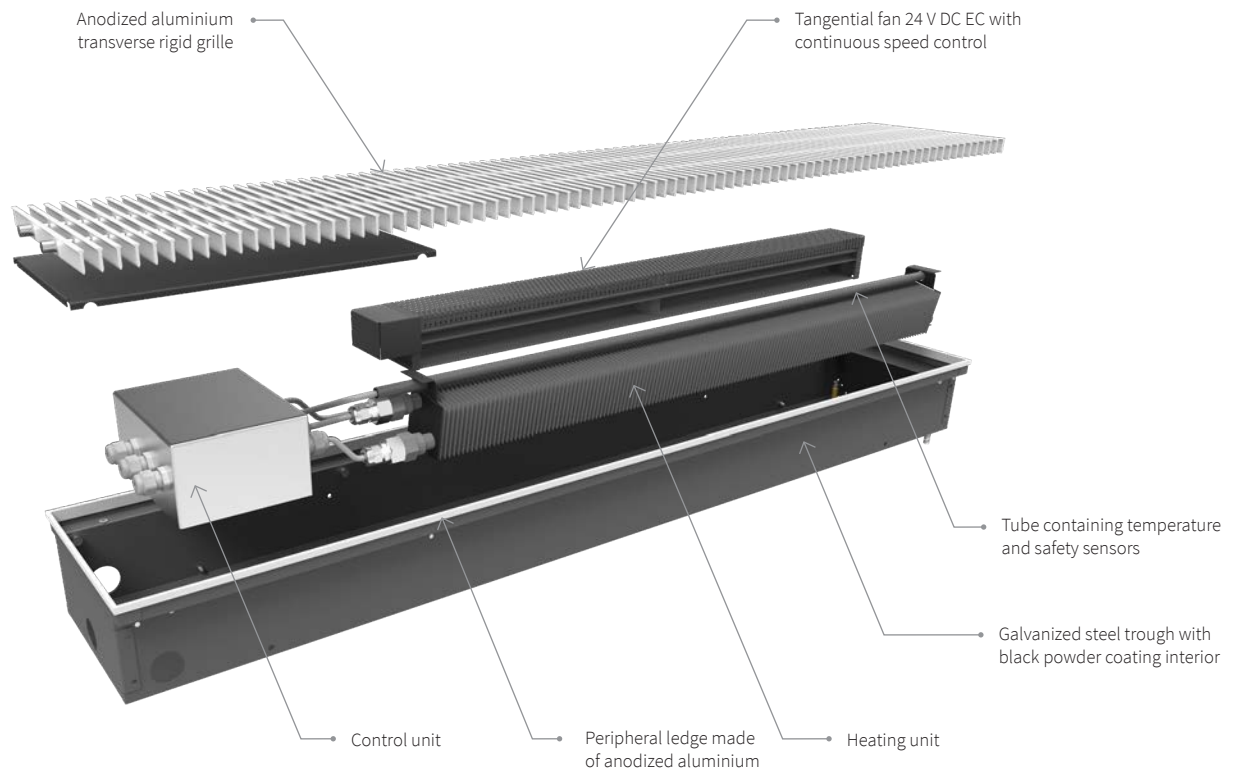

Trench heating wiring diagram

Basic wiring diagram for FET models with the RTD201 thermostat

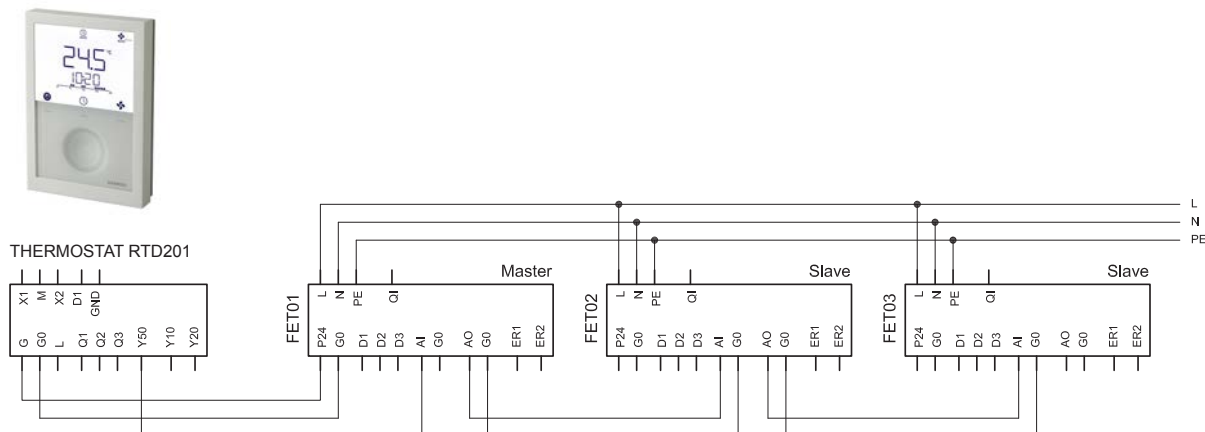

Basic wiring diagram for FEK models with the RTD301 thermostat

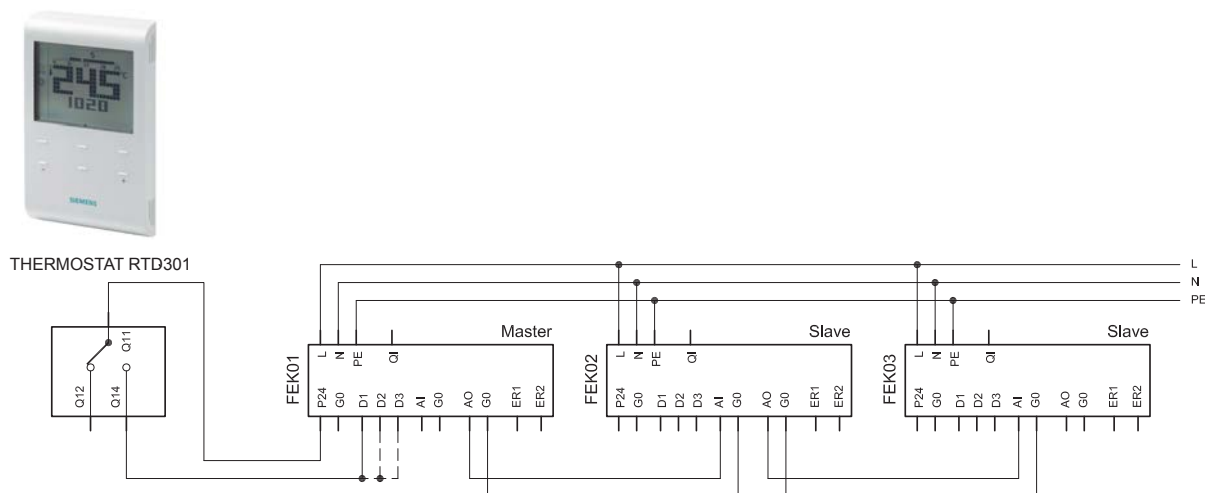

0...10 V DC continuous control

Both FET and FEK electric trench heaters allow for continuous control using a 0...10 V DC signal. The regulator uses this signal to adjust the heating unit output and, in FET models, to continuously regulate the fan speed.

This means that the heater continuously corrects any deviations from the desired room temperature. The RTD201 thermostat functions in the same way.

The 0...10 V DC control facilitates easy integration of the trench heater into modern BMS-controlled buildings and smart homes. All of these systems are capable of device control using the 0...10 V DC range. As the central control processes information obtained from room sensors, it proceeds to regulate the heating system, including trench heaters, based on the supplier-specified algorithm. The KNX protocol allows the use of the RTD201KN thermostat, capable of communicating with this higher-level control system (see the accessories).

Combination

It is possible to combine fan-forced and natural-convection trench heaters within one branch. The electricity network must be properly designed with consideration for the power input of individual units.

TERMO for the heating system with fan



Trench heaters TERMO with forced convection via a fan provide a very good thermal output. This is achieved via installed fans with longitudinal tangential rotors, which force air into a heat exchanger. The fans are fitted with effective electrically commuted (EC) motors functioning on the basis of safe voltage of 24 V DC.

The motors have very small consumption of electric power. The speeds of fans are controlled continuously with a controlling voltage of 0...10 V DC. The room thermostat secures the correct function of all installed TERMO trench heaters, compares the set and actual temperature in the room, opens the flowing of heating medium in the heat exchanger and controls the fan's revs according to the difference in the temperatures and the set mode of operation.

The use of new technologies secures the optimal heating of the interior, which results in energy savings, the economical operation of the trench heater, the high efficiency and flexibility of heating. The trench heater is powered with safe voltage only, all components are powered with direct current of 24 V.

The substantial range of the heights and widths of trench heaters gives the designer a lot of options for selecting a model with the required output for the composition of the floor in question. The necessary data are presented in data sheets of individual products, including the acoustic parameters of the trench heaters.

The range of models with a fan 24 V DC

Heating	Heating / cooling	Heating, humid environment	Heating, installed power supply	Heating and cooling, installed power supply
FRT <ul style="list-style-type: none"> › heating › with fan › lamellar exchanger › dry environment › page 32 	FRC <ul style="list-style-type: none"> › heating and cooling › 2 pipe, single circuit › with fan › lamellar exchanger › dry environment › page 84 	FRB <ul style="list-style-type: none"> › heating › with fan › lamellar exchanger › humid environment › page 94 	FRZ <ul style="list-style-type: none"> › heating › with fan › lamellar exchanger › installed power supply › dry environment › page 98 	FZC <ul style="list-style-type: none"> › heating and cooling › 2 pipe, single circuit › with fan › lamellar exchanger › dry environment › installed power supply › page 100
	FRD <ul style="list-style-type: none"> › heating and cooling › 4 pipe, double circuit › with fan › lamellar exchanger › dry environment › page 90 			FZD <ul style="list-style-type: none"> › heating and cooling › 4 pipe, double circuit › with fan › lamellar exchanger › dry environment › installed power supply › page 100

Trench heater „made to measure“

Based on the requirements of larger projects it is possible to supply a „made to measure“ trench heater with adjusted height and width. Having approved the structure we will submit a protocol from a test room presenting output parameters. We also offer modifications of the trench heater for the use in humid environment, the connection of air handling piping and others. The technical documentation is first consulted with the customer and only then the production of the trench heater starts.

Operating conditions

- › Installation in a hot water heating system with forced circulation
- › Maximal operating temperature of heating medium 110 °C
- › Maximal operating overpressure 1 MPa
- › Electric parts with IP20 cover protection, use in dry environment (FRB: use in wet environment)
- › Operating voltage 24 V DC
- › Ambient temperature +2 to +40 °C
- › Relative humidity of environment 20 to 70% (FRB: 20 - 100%)

Connecting to the mains

The connection into the electric circuit is done according to the scheme. The entire circuit is powered with a switched power supply (placed in the switchboard), which provides the voltage of 24 V DC. All trench heaters and the room thermostat are connected to this voltage. The cabling shall be sized to ensure that the voltage in distribution lines never drops below 22 V DC in any individual device. More details concerning the sizing of the electric circuit are presented on page 129.

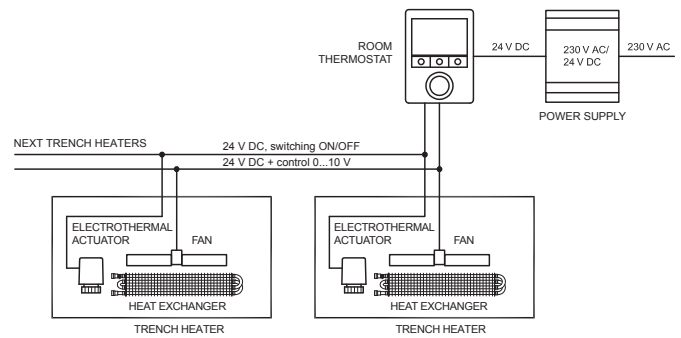

Connecting in the heating system

Lamellar **Al-Cu** heat exchangers have aluminium lamellas pressed onto a copper pipe through which the heating medium flows.

The pipe's outlet and inlet are equipped with a connecting end with internal thread G1/2". Normally the water connection of the exchanger is on the left side (when the exchanger is placed nearer the window).

We install a thermostatic valve fitted with an electrothermal actuator on the inlet of the lamellar heat exchanger. The actuator works in the opened/closed mode and controls the flow of the heating medium. It is not necessary to use a thermostatic valve if the temperature of the heating medium is controlled by the heating system (e.g. equithermal system). The way of regulation is to

be determined by the designer of the heating and this shall be specified in the project documentation.

A return regulating screw connection shall be used for the outlet. This enables the incorporation of the trench heater into the heating system from the viewpoint of the hydraulic balancing. Based on the parameters of the screw connection used the designer determines the setting (corresponding to pressure loss at the fitting) and this value shall be specified in the project documentation.

Each exchanger is fitted with an air vent valve. When the heating system is connected and filled air bubbles remain caught in the upper part of the exchanger. These shall be let out through the air vent valve.

Hydraulics

- Tables with hydraulic resistance are presented on page 126.
- Some trench heaters have a too high output at thermal gradient of 75/65/20°C, during the calculation of the required flow and hydraulic resistance we will exceed the recommended limitations.
- We design such trench heaters for low-temperature systems or systems with a high difference between inlet and outlet, in which the output and thus also the flow of the heating medium are at acceptable level. Let us consider the flow rate of the heating medium to be up to 300 kg/hour. The designer may increase the flow in the trench heater's exchanger being aware of the fact that this will increase hydraulic resistance and flow rate in the piping (correct sizing of overpressure and the pump), the table with hydraulic parameters is presented on page 126.
- If the output is too high, it is possible to use a trench heater with a reduced number of fans;
- it is best to consult our technical department ISAN Radiátory s.r.o. if this variant is to be selected.

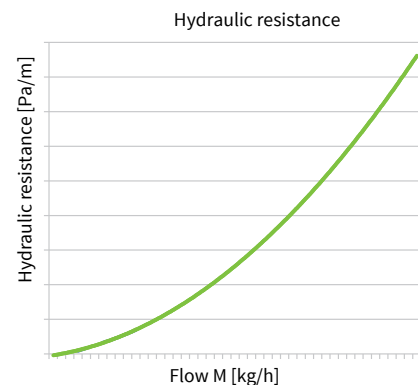

How to size the trench heater

What room the trench heater is to be placed in

We always consider output and acoustic parameters of the trench heater taking into account the room's nature – residential rooms, bedrooms, corridors, offices, theatres, hospital rooms, halls, presentation rooms and others. The trench heater shall comply with the requirement for thermal output at a selected temperature gradient, however at the same time the operation shall not disturb the user with excessive noise. The noise issue is regulated by the applicable standard, which defined permitted limits for individual types of rooms. (more info on page 13).

The output of the trench heater

The tables contain output data for thermal gradient 75/65/20°C, standardized output according to standard ČSN EN 16 430-2. This standard also

defines the procedure for conversion to other thermal gradients. The second table presents a converted thermal gradient of 55/45/20°C and a fast approximate conversion for gradients of 90/70/20°C and 70/55/20°C.

Cooling capacity is indicated for dry cooling 17/19/28 °C.

- Convert the output to the required thermal gradient, check acoustic parameters.
- It is not a problem if the calculated output is higher than the required one – the automatic regulation functions from the lowest revs per the output that is equal to the current thermal loss in the room, the trench heater will not overheat, on the contrary it will function with less noise (it will achieve the required output at lower revs), the comfort temperature in the room will be achieved faster

FRT





Fan-assisted trench heaters
with **lamellar heat exchanger,**
heating

TERMO FRT

Fan-assisted heaters with lamellar heat exchanger

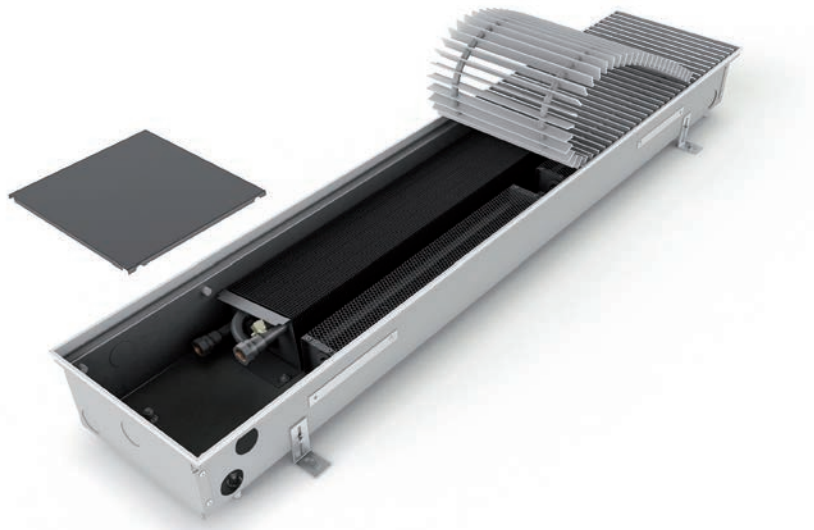

Trench heaters FRT with forced convection via a fan provide a very good thermal output. This is achieved via installed fans with longitudinal tangential rotors, which force air into a heat exchanger with lamellas. The fans are fitted with effective electrically commuted (EC) motors functioning on the basis of safe voltage of 24 V DC. The motors have very small consumption of electric power. The speeds of fans are controlled continuously with a controlling voltage of 0...10 V DC. The room thermostat secures the correct function of all installed FRT trench heaters, compares the set and actual temperature in the room, opens the flowing of heating medium in the heat exchanger and controls the fan's revs according to the difference in the temperatures and the set mode of operation.

The use of new technologies secures the optimal heating of the interior, which results in energy savings, the economical operation of the trench heater, the high efficiency and flexibility of heating. The trench heater is powered with safe voltage only, all components are powered with direct current of 24 V.

The substantial range of the heights and widths of trench heaters gives the designer a lot of options for selecting a model with the required output for the composition of the floor in question. The necessary data are presented in data sheets of individual products, including the acoustic parameters of the trench heaters.

The range of FRT models with a fan 24 V DC

Height	65 mm	80 mm	90 mm	110 mm	125 mm	140 mm
Width	175 mm	175 mm	175 mm	175 mm	-	-
	200 mm	200 mm	200 mm	200 mm	--	-
	250 mm	250 mm	250 mm	250 mm	250 mm	250 mm
	300 mm	300 mm	300 mm	300 mm	300 mm	300 mm
	-	-	425 mm	425 mm	425 mm	425 mm

Placement in the floor

The trench heaters are laid in the floor so that the heat exchanger is closer to the window side, while fans are placed deeper into the room. The vertical and horizontal distribution of temperatures in the heated room is uniform and conditions are created to provide thermal comfort. Air flow is comparable to the heat transfer with classical heating bodies placed on the wall below windows.

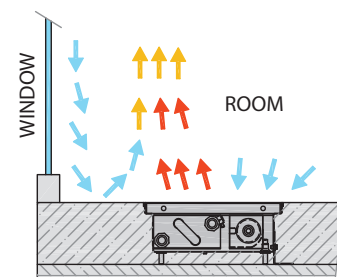

FRT overview of trench heaters with fan

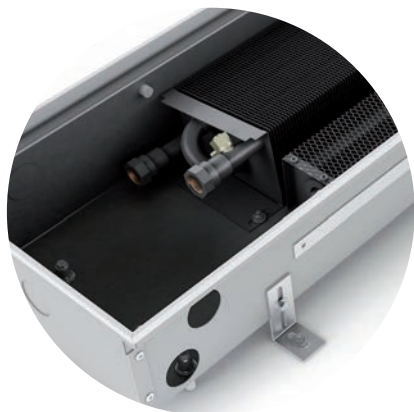
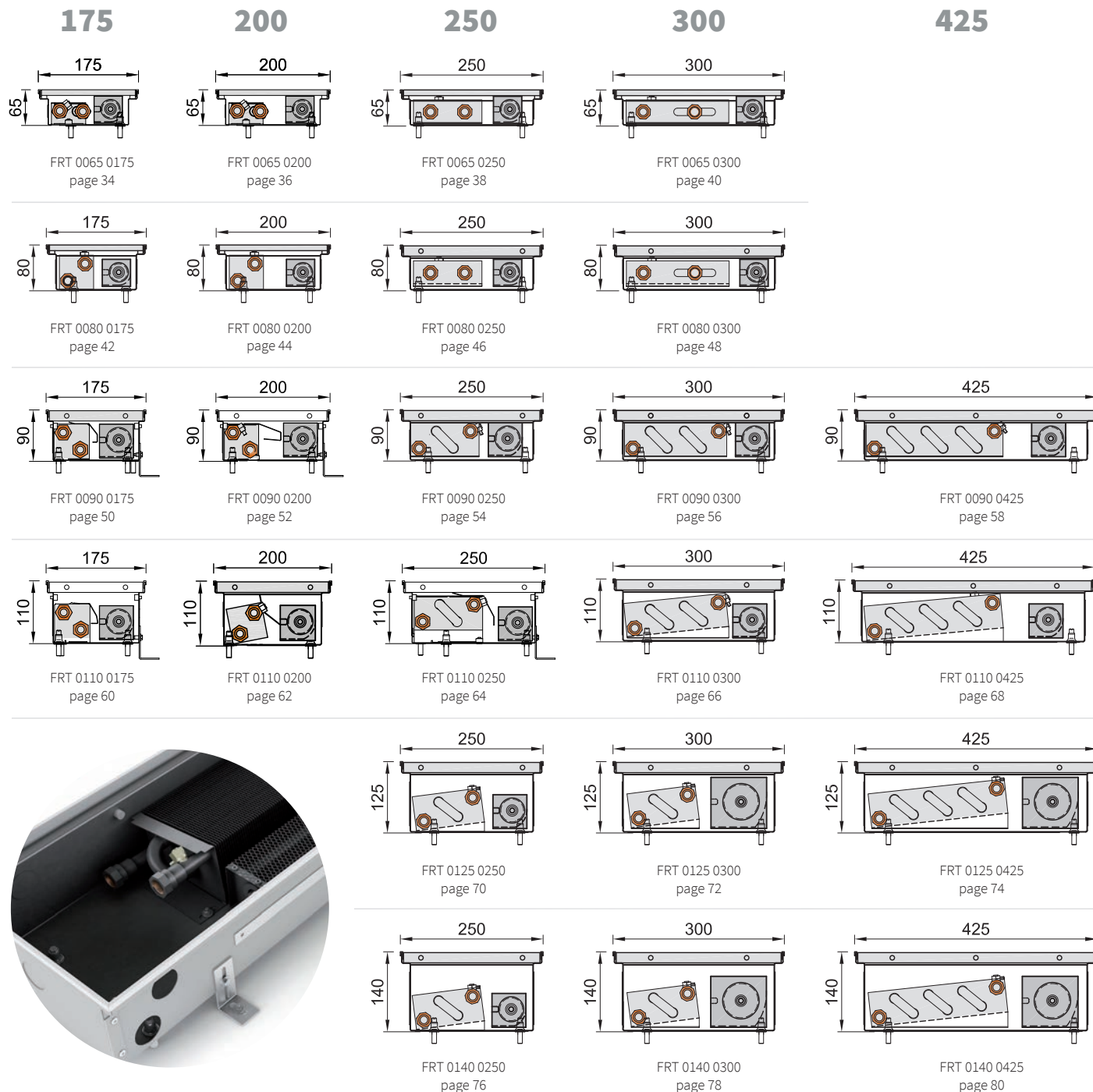

Trench heaters according to the customer's requirements

For the needs of large projects we may adjust the dimensions, structure and internal arrangement. A solution for humid spaces, the connection of an air handling system with modified air. Thermal output measurements will be supplied with the project.

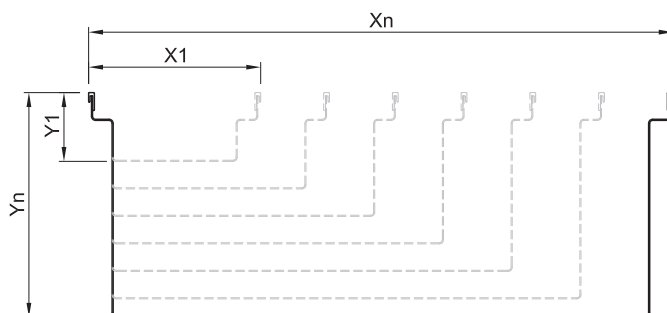

FRT 0065 0175

TRENCH HEATER WITH FAN



- › Flats, detached houses, offices, administrative buildings
- › The lowest and the most narrow fan assisted trench heater
- › High heating output
- › Continuous speed control
- › Quiet operation
- › Common electricity consumption **2 W/m**
- › Using in dry environment



Technical data

Trench heater

Height [H]	65 mm
Width [W]	175 mm
Length [L]	700-4800 mm in step 100 mm

Heat exchanger

Type	Al-Cu lamellar
Length	L-295 mm
Connection thread	2×G1/2" inner

Working conditions

Max. temperature	110 °C
Max. overpressure	1 MPa (10 bar)
Protection	IP 20
Ambient conditions	Temp. T = +2 to +40 °C Humidity Rh = 20 to 70%

Trench heater standard equipment

Trough	Galvanized steel trough with surface finish and black spray layer inside, black cover plates of connection
Heat exchanger	Al-Cu lamellar exchanger with air vent valve, black painted
Grille	Design walkable grille according the customer's choice
Ledge	Made of anodized aluminium, type and colour according the customer's choice
Fan	Modern tangential fan with 24 V DC EC motor with high efficiency
Assembly elements	Leveling screws for setting up the trough, mounting brackets
Manual	Manual for the progress of work during installation and user manual
Wiring	Electrical wiring diagram of the trench heaters
Mounting board	Cover and the spacer particle board for easy installation
Package	Transport package for protection against damage during transportation and handling

Technical drawing

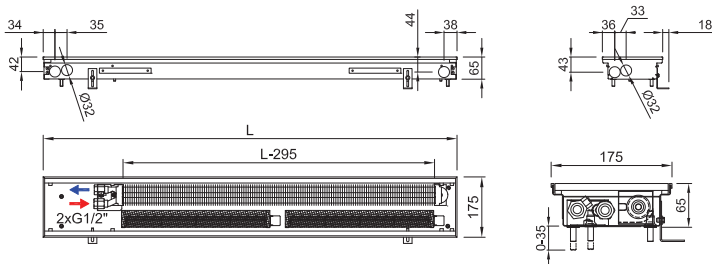

Connection to heating system

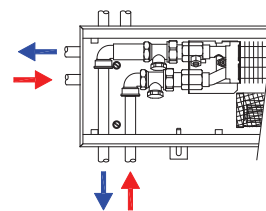

Electrothermal actuator can't be installed in the body of the trench heater due to limited internal space

Accessories per order



Room thermostat

Power supply

Lockshield valve

Variants

Grilles

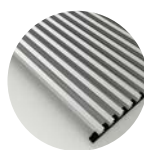

Transverse grilles

Peripheral ledge

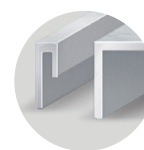

- ① Grilles → 6
- ② Ledges → 8
- ③ Acoustic power → 13
- ④ Accessories → 14
- ⑤ Hydraulic parameters → 126
- ⑥ Wiring → 129

Code example: FRT 0065 0175 1200 C 35 L3 L - 5

Trench heater FRT H = 65 mm, W = 175 mm, L = 1 200 mm, „C” Galvanized steel trough with black inside, heat exchanger and inner parts painted black, „35” Low black anodized aluminium grille, transverse, rigid „L3” peripheral ledge „L”, black anodized aluminium, „L” water connection on the left side (when installing the heat exchanger closer to the window, fans to the room) „5” 24 V DC fans without controller (controller is not needed)



Trench heater heating output FRT 0065 0175

Q[W] 75/65/20 °C (ΔT=50 °C)

Temperature exponent 1,1

Length L [mm]	Speed [-] / Heating output [W]					
	0 V	2 V	4 V	6 V	8 V	10 V
700	19	82	140	184	213	228
800	24	109	186	245	284	304
900	29	130	223	293	341	366
1 000	33	185	316	415	482	518
1 100	38	185	316	415	482	518
1 200	43	217	371	488	567	609
1 300	48	239	409	537	624	670
1 400	52	266	456	599	696	746
1 500	57	294	502	660	766	822
1 600	62	320	547	718	834	895
1 700	67	320	547	718	834	895
1 800	71	370	632	830	965	1 035
1 900	76	401	686	902	1 047	1 123
2 000	81	428	732	963	1 118	1 199
2 100	86	449	769	1 011	1 175	1 261
2 200	91	449	769	1 011	1 175	1 261
2 300	95	503	862	1 133	1 317	1 413
2 400	100	503	862	1 133	1 317	1 413
2 500	105	536	918	1 206	1 402	1 504
2 600	110	558	955	1 255	1 458	1 565
2 700	114	580	992	1 304	1 515	1 626
2 800	119	612	1 048	1 378	1 601	1 717
2 900	124	638	1 093	1 436	1 669	1 790
3 000	129	638	1 093	1 436	1 669	1 790
3 200	138	720	1 233	1 620	1 882	2 018
3 400	148	747	1 279	1 681	1 953	2 094
3 600	157	823	1 409	1 851	2 151	2 308
3 800	167	850	1 455	1 912	2 222	2 384
4 000	176	899	1 538	2 022	2 349	2 521
4 200	186	958	1 639	2 154	2 503	2 685
4 400	195	1 008	1 725	2 266	2 633	2 825
4 600	205	1 067	1 826	2 399	2 787	2 989
4 800	214	1 088	1 862	2 447	2 843	3 051

75/65/20 °C → 75°C inlet temperature, 65°C outlet temp., 20 °C room temp. / Output 90/70/20 °C = ~ 1,22 x 75/65/20 °C / Output 70/55/20 °C = ~ 0,84 x 75/65/20 °C / Heating outputs in accordance with EN 16430 / Not listed heating outputs for lengths per 100 mm steps calculate linearly. Exact values can be found at www.isan.cz

Q[W] 55/45/20 °C (ΔT=30 °C)

Length L [mm]	Speed [-] / Heating output [W]					
	0 V	2 V	4 V	6 V	8 V	10 V
700	9	47	80	105	121	130
800	12	62	106	140	162	173
900	14	74	127	167	194	209
1 000	16	105	180	237	275	295
1 100	18	105	180	237	275	295
1 200	21	124	212	278	323	347
1 300	23	136	233	306	356	382
1 400	25	152	260	342	397	425
1 500	28	168	286	376	437	469
1 600	30	182	312	409	475	510
1 700	32	182	312	409	475	510
1 800	34	211	360	473	550	590
1 900	37	229	391	514	597	640
2 000	39	244	417	549	637	684
2 100	42	256	438	576	670	719
2 200	44	256	438	576	670	719
2 300	46	287	491	646	751	806
2 400	48	287	491	646	751	806
2 500	51	306	523	688	799	857
2 600	53	318	544	716	831	892
2 700	55	331	566	743	864	927
2 800	58	349	597	786	913	979
2 900	60	364	623	819	952	1 021
3 000	62	364	623	819	952	1 021
3 200	67	410	703	924	1 073	1 151
3 400	72	426	729	958	1 113	1 194
3 600	76	469	803	1 055	1 226	1 316
3 800	81	485	830	1 090	1 267	1 359
4 000	85	513	877	1 153	1 339	1 437
4 200	90	546	934	1 228	1 427	1 531
4 400	94	575	983	1 292	1 501	1 611
4 600	99	608	1 041	1 368	1 589	1 704
4 800	104	620	1 062	1 395	1 621	1 739

Acoustic power [dB(A)]

Length L [mm]	Speed [-] / Acoustic power [dB(A)]					
	0 V	2 V	4 V	6 V	8 V	10 V
700	-	< 25	< 25	25	31	36
800	-	< 25	< 25	26	31	37
900	-	< 25	< 25	26	32	37
1 000	-	< 25	< 25	27	32	38
1 100	-	< 25	< 25	28	32	38
1 200	-	< 25	< 25	28	32	38
1 300	-	< 25	< 25	28	33	39
1 400	-	< 25	26	28	33	39
1 500	-	< 25	26	29	33	39
1 600	-	< 25	26	29	33	40
1 700	-	< 25	26	29	34	40
1 800	-	< 25	26	29	34	40
1 900	-	< 25	27	30	34	40
2 000	-	< 25	27	30	34	41
2 100	-	< 25	27	30	34	41
2 200	-	< 25	27	30	35	41
2 300	-	< 25	27	30	35	41
2 400	-	< 25	27	31	35	41
2 500	-	< 25	27	31	35	41
2 600	-	25	27	31	36	42
2 700	-	25	27	31	36	42
2 800	-	25	27	31	36	42
2 900	-	25	27	31	36	42
3 000	-	25	28	31	36	42
3 200	-	26	28	32	36	42
3 400	-	26	28	32	37	43
3 600	-	26	28	32	37	43
3 800	-	26	28	32	37	43
4 000	-	26	29	32	37	43
4 200	-	26	29	33	38	44
4 400	-	27	29	33	38	44
4 600	-	27	29	33	38	44
4 800	-	27	29	33	38	44

Fans input power [W]*

Length L [mm]	Number of fans	Speed [-] / Fans input power [W]*				
		2 V	4 V	6 V	8 V	10 V
700	1	1	1	1	2	2
800	1	1	1	1	2	2
900	1	1	1	2	2	2
1 000	1	1	1	2	2	3
1 100	1	1	1	2	2	3
1 200	2	2	2	2	3	4
1 300	2	2	2	3	3	4
1 400	2	2	2	3	3	5
1 500	2	2	2	3	4	5
1 600	1	1	1	2	3	5
1 700	2	2	2	3	4	5
1 800	2	2	2	3	4	5
1 900	2	2	2	3	4	6
2 000	2	2	2	3	4	7
2 100	2	2	2	3	4	7
2 200	2	2	2	3	4	7
2 300	2	2	2	3	4	7
2 400	2	2	2	3	4	7
2 500	3	3	3	4	6	9
2 600	3	3	3	4	6	9
2 700	3	3	3	4	6	9
2 800	3	3	3	4	6	9
2 900	2	2	2	3	5	9
3 000	3	3	3	4	6	9
3 200	3	3	3	4	6	11
3 400	3	3	3	4	6	11
3 600	3	3	3	5	6	12
3 800	4	3	4	6	7	13
4 000	4	3	4	6	8	13
4 200	3	3	3	5	7	13
4 400	4	3	4	6	8	14
4 600	4	3	4	6	8	15
4 800	4	3	4	6	8	15

* Approximate fan input powers / When using electrothermal actuator add in the trench heater's power 3 W

FRT 0065 0200

TRENCH HEATER WITH FAN



- › Flats, detached houses, offices, administrative buildings
- › The lowest and narrow fan assisted trench heater
- › High heating output
- › Continuous speed control
- › Quiet operation
- › Common electricity consumption **2 W/m**
- › Using in dry environment



Technical data

Trench heater

Height [H]	65 mm
Width [W]	200 mm
Length [L]	700-4800 mm in step 100 mm

Heat exchanger

Type	Al-Cu lamellar
Length	L-295 mm
Connection thread	2xG1/2" inner

Working conditions

Max. temperature	110 °C
Max. overpressure	1 MPa (10 bar)
Protection	IP 20
Ambient conditions	Temp. T = +2 to +40 °C Humidity Rh = 20 to 70%

Trench heater standard equipment

Trough	Galvanized steel trough with surface finish and black spray layer inside, black cover plates of connection
Heat exchanger	Al-Cu lamellar exchanger with air vent valve, black painted
Grille	Design walkable grille according to the customer's choice
Ledge	Made of anodized aluminium, type and colour according to the customer's choice
Fan	Modern tangential fan with 24 V DC EC motor with high efficiency
Assembly elements	Leveling screws for setting up the trough, mounting brackets
Manual	Manual for the progress of work during installation and user manual
Wiring	Electrical wiring diagram of the trench heaters
Mounting board	Cover and the spacer particle board for easy installation
Package	Transport package for protection against damage during transportation and handling

Technical drawing

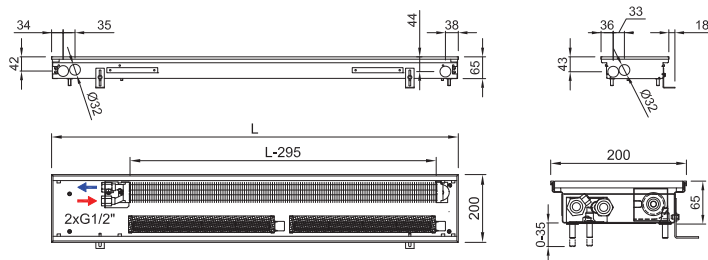

Connection to heating system

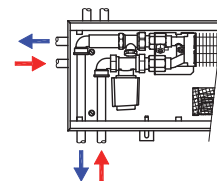

Accessories per order



Variants

Grilles

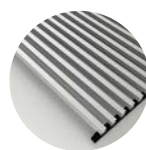

Transverse grilles

Peripheral ledge

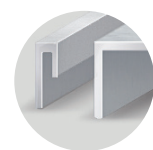

① Grilles → 6 ② Ledges → 8 ③ Acoustic power → 13 ④ Accessories → 14 ⑤ Hydraulic parameters → 126 ⑥ Wiring → 129

Code example: FRT 0065 0200 2000 C 25 J2 L - 5

Trench heater FRT H = 65 mm, W = 200 mm, L = 2 000 mm, „C“ Galvanized steel trough with black inside, heat exchanger and inner parts painted black, „25“ Low bronze anodized aluminium grille, transverse, rigid, „J2“ peripheral ledge „J“, bronze anodized aluminium, „L“ water connection on the left side (when installing the heat exchanger closer to the window, fans to the room) „5“ 24 V DC fans without controller (controller is not needed)



Trench heater heating output FRT 0065 0200

Q[W] 75/65/20 °C (ΔT=50 °C)

Temperature exponent 1,1

Length L [mm]	Speed [-] / Heating output [W]					
	0 V	2 V	4 V	6 V	8 V	10 V
700	23	84	142	193	237	273
800	29	112	190	258	316	365
900	34	134	228	310	380	437
1 000	40	189	323	440	538	619
1 100	46	189	323	440	538	619
1 200	51	223	380	517	633	728
1 300	57	245	418	568	696	802
1 400	63	273	466	633	775	892
1 500	69	300	513	698	855	983
1 600	74	327	559	760	930	1 071
1 700	80	327	559	760	930	1 071
1 800	86	379	646	878	1 076	1 239
1 900	91	411	701	953	1 167	1 344
2 000	97	439	749	1 018	1 247	1 435
2 100	103	461	787	1 070	1 310	1 508
2 200	108	461	787	1 070	1 310	1 508
2 300	114	517	882	1 199	1 468	1 690
2 400	120	517	882	1 199	1 468	1 690
2 500	125	550	939	1 277	1 563	1 799
2 600	131	572	976	1 328	1 627	1 872
2 700	137	594	1 015	1 380	1 690	1 945
2 800	143	628	1 072	1 457	1 785	2 054
2 900	148	655	1 117	1 519	1 861	2 142
3 000	154	655	1 117	1 519	1 861	2 142
3 200	165	738	1 259	1 712	2 097	2 415
3 400	177	767	1 307	1 777	2 177	2 506
3 600	188	844	1 441	1 959	2 399	2 760
3 800	199	872	1 488	2 023	2 477	2 852
4 000	211	922	1 573	2 139	2 620	3 016
4 200	222	982	1 676	2 279	2 791	3 212
4 400	234	1 034	1 763	2 398	2 937	3 380
4 600	245	1 094	1 866	2 537	3 107	3 577
4 800	256	1 116	1 904	2 589	3 171	3 649

75/65/20 °C → 75 °C inlet temperature, 65 °C outlet temp., 20 °C room temp. / Output 90/70/20 °C = ~ 1,22 x 75/65/20 °C / Output 70/55/20 °C = ~ 0,84 x 75/65/20 °C / Heating outputs in accordance with EN 16430 / Not listed heating outputs for lengths per 100 mm steps calculate linearly. Exact values can be found at www.isan.cz

Q[W] 55/45/20 °C (ΔT=30 °C)

Length L [mm]	Speed [-] / Heating output [W]					
	0 V	2 V	4 V	6 V	8 V	10 V
700	11	48	81	110	135	156
800	14	64	108	147	180	208
900	16	76	130	177	217	249
1 000	19	108	184	251	307	353
1 100	22	108	184	251	307	353
1 200	25	127	217	295	361	415
1 300	28	140	238	324	397	457
1 400	31	156	266	361	442	509
1 500	33	171	292	398	487	560
1 600	36	186	319	433	530	611
1 700	39	186	319	433	530	611
1 800	42	216	368	501	613	706
1 900	44	234	400	543	665	766
2 000	47	250	427	580	711	818
2 100	50	263	449	610	747	860
2 200	52	263	449	610	747	860
2 300	55	295	503	684	837	964
2 400	58	295	503	684	837	964
2 500	61	314	535	728	891	1 026
2 600	63	326	556	757	928	1 067
2 700	66	339	579	787	964	1 109
2 800	69	358	611	831	1 018	1 171
2 900	72	373	637	866	1 061	1 221
3 000	75	373	637	866	1 061	1 221
3 200	80	421	718	976	1 196	1 377
3 400	86	437	745	1 013	1 241	1 429
3 600	91	481	822	1 117	1 368	1 574
3 800	96	497	848	1 153	1 412	1 626
4 000	102	526	897	1 219	1 494	1 719
4 200	107	560	956	1 299	1 591	1 831
4 400	113	590	1 005	1 367	1 674	1 927
4 600	119	624	1 064	1 446	1 771	2 039
4 800	124	636	1 086	1 476	1 808	2 080

Acoustic power [dB(A)]

Length L [mm]	Speed [-] / Acoustic power [dB(A)]					
	0 V	2 V	4 V	6 V	8 V	10 V
700	-	< 25	< 25	25	31	36
800	-	< 25	< 25	26	31	37
900	-	< 25	< 25	26	32	37
1 000	-	< 25	< 25	27	32	38
1 100	-	< 25	< 25	28	32	38
1 200	-	< 25	< 25	28	32	38
1 300	-	< 25	< 25	28	33	39
1 400	-	< 25	26	28	33	39
1 500	-	< 25	26	29	33	39
1 600	-	< 25	26	29	33	40
1 700	-	< 25	26	29	34	40
1 800	-	< 25	26	29	34	40
1 900	-	< 25	27	30	34	40
2 000	-	< 25	27	30	34	41
2 100	-	< 25	27	30	34	41
2 200	-	< 25	27	30	35	41
2 300	-	< 25	27	30	35	41
2 400	-	< 25	27	31	35	41
2 500	-	< 25	27	31	35	41
2 600	-	25	27	31	36	42
2 700	-	25	27	31	36	42
2 800	-	25	27	31	36	42
2 900	-	25	27	31	36	42
3 000	-	25	28	31	36	42
3 200	-	26	28	32	36	42
3 400	-	26	28	32	37	43
3 600	-	26	28	32	37	43
3 800	-	26	28	32	37	43
4 000	-	26	29	32	37	43
4 200	-	26	29	33	38	44
4 400	-	27	29	33	38	44
4 600	-	27	29	33	38	44
4 800	-	27	29	33	38	44

Fans input power [W]*

Length L [mm]	Number of fans	Speed [-] / Fans input power [W]*				
		2 V	4 V	6 V	8 V	10 V
700	1	1	1	1	2	2
800	1	1	1	1	2	2
900	1	1	1	2	2	2
1 000	1	1	1	2	2	3
1 100	1	1	1	2	2	3
1 200	2	2	2	2	3	4
1 300	2	2	2	3	3	4
1 400	2	2	2	3	3	5
1 500	2	2	2	3	4	5
1 600	1	1	1	2	3	5
1 700	2	2	2	3	4	5
1 800	2	2	2	3	4	5
1 900	2	2	2	3	4	6
2 000	2	2	2	3	4	7
2 100	2	2	2	3	4	7
2 200	2	2	2	3	4	7
2 300	2	2	2	3	4	7
2 400	2	2	2	3	4	7
2 500	3	3	3	4	6	9
2 600	3	3	3	4	6	9
2 700	3	3	3	4	6	9
2 800	3	3	3	4	6	9
2 900	2	2	2	3	5	9
3 000	3	3	3	4	6	9
3 200	3	3	3	4	6	11
3 400	3	3	3	4	6	11
3 600	3	3	3	5	6	12
3 800	4	3	4	6	7	13
4 000	4	3	4	6	8	13
4 200	3	3	3	5	7	13
4 400	4	3	4	6	8	14
4 600	4	3	4	6	8	15
4 800	4	3	4	6	8	15

* Approximate fan input powers / When using electrothermal actuator add in the trench heater's power 3 W

FRT 0065 0250

TRENCH HEATER WITH FAN



- › Flats, detached houses, offices, administrative buildings
- › The lowest and narrow fan assisted trench heater
- › High heating output
- › Continuous speed control
- › Quiet operation
- › Common electricity consumption **2 W/m**
- › Using in dry environment

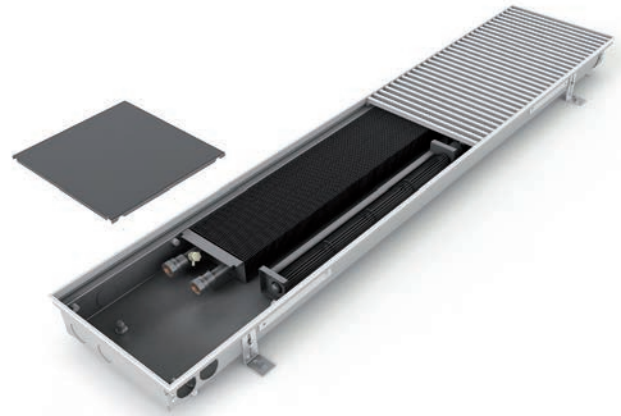

Technical data

Trench heater

Height [H]	65 mm
Width [W]	250 mm
Length [L]	700-4 800 mm in step 100 mm

Heat exchanger

Type	Al-Cu lamellar
Length	L-295 mm
Connection thread	2xG1/2" inner

Working conditions

Max. temperature	110 °C
Max. overpressure	1 MPa (10 bar)
Protection	IP 20
Ambient conditions	Temp. T = +2 to +40 °C Humidity Rh = 20 to 70%

Trench heater standard equipment

Trough	Galvanized steel trough with surface finish and black spray layer inside, black cover plates of connection
Heat exchanger	Al-Cu lamellar exchanger with air vent valve, black painted
Grille	Design walkable grille according the customer's choice
Ledge	Made of anodized aluminium, type and colour according the customer's choice
Fan	Modern tangential fan with 24 V DC EC motor with high efficiency
Assembly elements	Leveling screws for setting up the trough, mounting brackets
Manual	Manual for the progress of work during installation and user manual
Wiring	Electrical wiring diagram of the trench heaters
Mounting board	Cover and the spacer particle board for easy installation
Package	Transport package for protection against damage during transportation and handling

Technical drawing

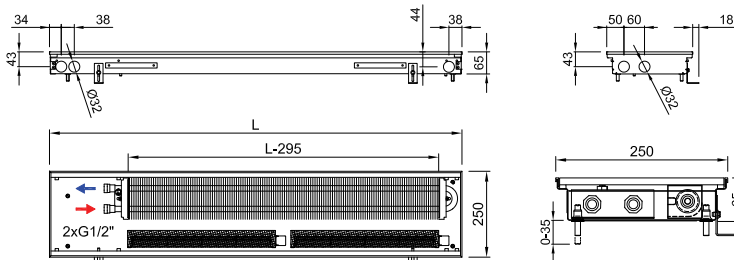

Connection to heating system

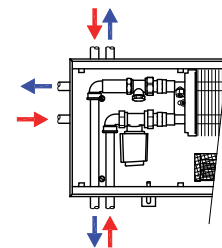

Accessories per order



Variants

Grilles



Transverse grilles - rigid

Peripheral ledge

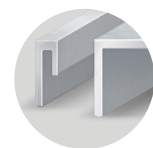

① Grilles → 6 ② Ledges → 8 ③ Acoustic power → 13 ④ Accessories → 14 ⑤ Hydraulic parameters → 126 ⑥ Wiring → 129

Code example: FRT 0065 0250 1600 C 15 J1 L - 5

Trench heater **FRT** H=65 mm, W=250 mm, L=1 600 mm, „C” Galvanized steel trough with black inside, heat exchanger and inner parts painted black, „15” Low natural anodized aluminium grille, transverse, rigid, „J1” peripheral ledge „J”, natur anodized aluminium, „L” water connection at the left side (when installing the heat exchanger closer to the window, fans to the room), „5” 24 V DC fans without controller (controller is not needed)



Trench heater heating output FRT 0065 0250

Q[W] 75/65/20 °C (ΔT=50 °C)

Temperature exponent 1,1

Length L [mm]	Speed [-] / Heating output [W]					
	0 V	2 V	4 V	6 V	8 V	10 V
700	41	148	234	316	395	471
800	51	197	312	422	527	628
900	61	237	374	506	632	753
1 000	71	335	530	717	896	1 067
1 100	81	335	530	717	896	1 067
1 200	91	395	624	844	1 054	1 255
1 300	101	434	686	928	1 159	1 381
1 400	111	483	764	1 033	1 291	1 538
1 500	122	533	842	1 139	1 423	1 695
1 600	132	583	921	1 246	1 557	1 855
1 700	142	583	921	1 246	1 557	1 855
1 800	152	671	1 060	1 434	1 792	2 134
1 900	162	731	1 155	1 563	1 953	2 325
2 000	172	780	1 233	1 668	2 084	2 482
2 100	182	820	1 296	1 752	2 190	2 608
2 200	192	820	1 296	1 752	2 190	2 608
2 300	202	918	1 452	1 963	2 453	2 921
2 400	212	918	1 452	1 963	2 453	2 921
2 500	222	977	1 545	2 090	2 611	3 110
2 600	233	1 017	1 608	2 174	2 717	3 235
2 700	243	1 056	1 670	2 258	2 822	3 361
2 800	253	1 116	1 763	2 385	2 980	3 549
2 900	263	1 166	1 843	2 493	3 115	3 709
3 000	273	1 166	1 843	2 493	3 115	3 709
3 200	293	1 314	2 077	2 809	3 510	4 180
3 400	313	1 363	2 155	2 914	3 642	4 337
3 600	333	1 501	2 373	3 210	4 010	4 776
3 800	354	1 551	2 451	3 315	4 142	4 933
4 000	374	1 639	2 591	3 505	4 379	5 215
4 200	394	1 749	2 764	3 739	4 672	5 564
4 400	414	1 837	2 903	3 927	4 906	5 843
4 600	434	1 946	3 076	4 161	5 199	6 191
4 800	454	1 986	3 139	4 245	5 304	6 317

75/65/20 °C → 75°C inlet temperature, 65°C outlet temp., 20 °C room temp. / Output 90/70/20 °C = ~ 1,22 x 75/65/20 °C / Output 70/55/20 °C = ~ 0,84 x 75/65/20 °C / Heating outputs in accordance with EN 16430 / Not listed heating outputs for lengths per 100 mm steps calculate linearly. Exact values can be found at www.isan.cz

Acoustic power [dB(A)]

Length L [mm]	Speed [-] / Acoustic power [dB(A)]					
	0 V	2 V	4 V	6 V	8 V	10 V
700	-	< 25	< 25	27	32	39
800	-	< 25	< 25	27	33	40
900	-	< 25	< 25	28	33	40
1 000	-	< 25	< 25	28	34	41
1 100	-	< 25	< 25	29	34	41
1 200	-	< 25	25	29	35	41
1 300	-	< 25	25	30	35	42
1 400	-	< 25	26	30	36	42
1 500	-	< 25	26	30	36	42
1 600	-	< 25	26	31	36	43
1 700	-	< 25	26	31	36	43
1 800	-	< 25	27	31	37	43
1 900	-	< 25	27	31	37	43
2 000	-	< 25	27	32	37	44
2 100	-	< 25	27	32	37	44
2 200	-	< 25	28	32	38	44
2 300	-	< 25	28	32	38	44
2 400	-	< 25	28	32	38	44
2 500	-	25	28	33	38	45
2 600	-	25	29	33	39	45
2 700	-	25	29	33	39	45
2 800	-	25	29	33	39	45
2 900	-	26	29	33	39	45
3 000	-	26	29	33	39	45
3 200	-	26	30	34	40	46
3 400	-	26	30	34	40	46
3 600	-	27	30	34	40	46
3 800	-	27	30	35	40	46
4 000	-	27	31	35	41	47
4 200	-	27	31	35	41	47
4 400	-	27	31	35	41	47
4 600	-	28	31	35	41	47
4 800	-	28	31	36	41	47

Q[W] 55/45/20 °C (ΔT=30 °C)

Length L [mm]	Speed [-] / Heating output [W]					
	0 V	2 V	4 V	6 V	8 V	10 V
700	20	84	133	180	225	269
800	25	112	178	241	300	358
900	30	135	213	288	360	429
1 000	34	191	302	409	511	608
1 100	39	191	302	409	511	608
1 200	44	225	356	481	601	716
1 300	49	247	391	529	661	787
1 400	54	275	436	589	736	877
1 500	59	304	480	649	811	966
1 600	64	332	525	710	888	1 058
1 700	69	332	525	710	888	1 058
1 800	74	383	604	818	1 022	1 217
1 900	78	417	658	891	1 113	1 326
2 000	83	445	703	951	1 188	1 415
2 100	88	467	739	999	1 249	1 487
2 200	93	467	739	999	1 249	1 487
2 300	98	523	828	1 119	1 399	1 665
2 400	103	523	828	1 119	1 399	1 665
2 500	107	557	881	1 192	1 489	1 773
2 600	113	580	917	1 239	1 549	1 844
2 700	118	602	952	1 287	1 609	1 916
2 800	122	636	1 005	1 360	1 699	2 023
2 900	127	665	1 051	1 421	1 776	2 115
3 000	132	665	1 051	1 421	1 776	2 115
3 200	142	749	1 184	1 601	2 001	2 383
3 400	152	777	1 229	1 661	2 076	2 473
3 600	161	856	1 353	1 830	2 286	2 723
3 800	171	884	1 397	1 890	2 361	2 812
4 000	181	934	1 477	1 998	2 497	2 973
4 200	191	997	1 576	2 132	2 664	3 172
4 400	200	1 047	1 655	2 239	2 797	3 331
4 600	210	1 109	1 754	2 372	2 964	3 530
4 800	220	1 132	1 790	2 420	3 024	3 601

Fans input power [W]*

Length L [mm]	Number of fans	Speed [-] / Fans input power [W]*				
		2 V	4 V	6 V	8 V	10 V
700	1	1	1	1	2	2
800	1	1	1	1	2	2
900	1	1	1	2	2	2
1 000	1	1	1	2	2	3
1 100	1	1	1	2	2	3
1 200	2	2	2	2	3	4
1 300	2	2	2	3	3	4
1 400	2	2	2	3	3	5
1 500	2	2	2	3	4	5
1 600	1	1	1	2	3	5
1 700	2	2	2	3	4	5
1 800	2	2	2	3	4	5
1 900	2	2	2	3	4	6
2 000	2	2	2	3	4	7
2 100	2	2	2	3	4	7
2 200	2	2	2	3	4	7
2 300	2	2	2	3	4	7
2 400	2	2	2	3	4	7
2 500	3	3	3	4	6	9
2 600	3	3	3	4	6	9
2 700	3	3	3	4	6	9
2 800	3	3	3	4	6	9
2 900	2	2	2	3	5	9
3 000	3	3	3	4	6	9
3 200	3	3	3	4	6	11
3 400	3	3	3	4	6	11
3 600	3	3	3	5	6	12
3 800	4	3	4	6	7	13
4 000	4	3	4	6	8	13
4 200	3	3	3	5	7	13
4 400	4	3	4	6	8	14
4 600	4	3	4	6	8	15
4 800	4	3	4	6	8	15

* Approximate fan input powers / When using electrothermal actuator add in the trench heater's power 3 W

FRT 0065 0300

TRENCH HEATER WITH FAN



- › Flats, detached houses, offices, administrative buildings
- › Low construction of the trench heater
- › High heating output
- › Continuous speed control
- › Quiet operation
- › Common electricity consumption **2 W/m**
- › Using in dry environment



Technical data

Trench heater

Height [H]	65 mm
Width [W]	300 mm
Length [L]	700-4800 mm in step 100 mm

Heat exchanger

Type	Al-Cu lamellar
Length	L-295 mm
Connection thread	2xG1/2" inner

Working conditions

Max. temperature	110 °C
Max. overpressure	1 MPa (10 bar)
Protection	IP 20
Ambient conditions	Temp. T = +2 to +40 °C Humidity Rh = 20 to 70%

Trench heater standard equipment

Trough	Galvanized steel trough with surface finish and black spray layer inside, black cover plates of connection
Heat exchanger	Al-Cu lamellar exchanger with air vent valve, black painted
Grille	Design walkable grille according to the customer's choice
Ledge	Made of anodized aluminium, type and colour according to the customer's choice
Fan	Modern tangential fan with 24 V DC EC motor with high efficiency
Assembly elements	Leveling screws for setting up the trough, mounting brackets
Manual	Manual for the progress of work during installation and user manual
Wiring	Electrical wiring diagram of the trench heaters
Mounting board	Cover and the spacer particle board for easy installation
Package	Transport package for protection against damage during transportation and handling

Technical drawing

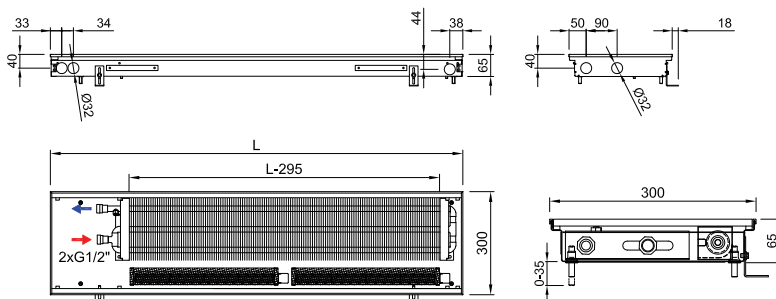

Connection to heating system

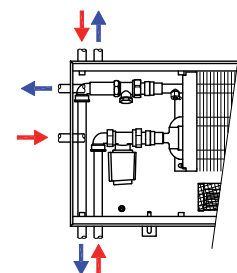

Accessories per order



Variants

Grilles



Transverse grilles - rigid

Peripheral ledge

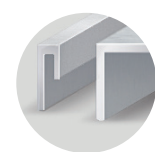

- ① Grilles → 6
- ② Ledges → 8
- ③ Acoustic power → 13
- ④ Accessories → 14
- ⑤ Hydraulic parameters → 126
- ⑥ Wiring → 129

Code example: FRT 0065 0300 2000 C 25 J2 R - 5

Trench heater **FRT** H=65 mm, W= 300 mm, L= 2 000 mm, „C“ Galvanized steel trough with black inside, heat exchanger and inner parts painted black, „25“ Low bronze anodized aluminium grille, transverse, rigid, „J2“ peripheral ledge „J“, bronze anodized aluminium, „R“ water connection at the right side (when installing the heat exchanger closer to the window, fans to the room), „5“ 24 V DC fans without controller (controller is not needed)



Trench heater heating output FRT 0065 0300

Q[W] 75/65/20 °C (ΔT=50 °C)

Temperature exponent 1,1

Length L [mm]	Speed [-] / Heating output [W]					
	0 V	2 V	4 V	6 V	8 V	10 V
700	49	178	293	395	485	563
800	61	237	391	527	647	750
900	73	285	469	633	776	900
1 000	85	403	664	896	1 100	1 275
1 100	97	403	664	896	1 100	1 275
1 200	109	474	781	1 054	1 294	1 500
1 300	121	522	859	1 160	1 423	1 650
1 400	134	581	957	1 292	1 585	1 838
1 500	146	640	1 054	1 423	1 747	2 025
1 600	158	701	1 154	1 558	1 912	2 217
1 700	170	701	1 154	1 558	1 912	2 217
1 800	182	806	1 328	1 792	2 200	2 551
1 900	194	879	1 447	1 953	2 397	2 779
2 000	206	938	1 545	2 085	2 559	2 967
2 100	218	986	1 623	2 190	2 688	3 117
2 200	230	986	1 623	2 190	2 688	3 117
2 300	242	1 104	1 818	2 454	3 012	3 492
2 400	254	1 104	1 818	2 454	3 012	3 492
2 500	266	1 175	1 935	2 612	3 206	3 717
2 600	278	1 223	2 013	2 718	3 335	3 867
2 700	291	1 270	2 091	2 823	3 465	4 017
2 800	303	1 341	2 209	2 981	3 659	4 242
2 900	315	1 402	2 308	3 116	3 824	4 433
3 000	327	1 402	2 308	3 116	3 824	4 433
3 200	351	1 580	2 601	3 511	4 309	4 996
3 400	375	1 639	2 699	3 643	4 471	5 184
3 600	399	1 805	2 972	4 012	4 924	5 709
3 800	423	1 864	3 070	4 144	5 086	5 896
4 000	448	1 971	3 246	4 381	5 377	6 234
4 200	472	2 103	3 462	4 673	5 736	6 650
4 400	496	2 208	3 636	4 908	6 024	6 984
4 600	520	2 340	3 853	5 200	6 383	7 400
4 800	544	2 387	3 931	5 306	6 512	7 550

75/65/20 °C → 75 °C inlet temperature, 65 °C outlet temp., 20 °C room temp. / Output 90/70/20 °C = ~ 1,22 x 75/65/20 °C / Output 70/55/20 °C = ~ 0,84 x 75/65/20 °C / Heating outputs in accordance with EN 16430 / Not listed heating outputs for lengths per 100 mm steps calculate linearly. Exact values can be found at www.isan.cz

Acoustic power [dB(A)]

Length L [mm]	Speed [-] / Acoustic power [dB(A)]					
	0 V	2 V	4 V	6 V	8 V	10 V
700	-	< 25	< 25	27	33	40
800	-	< 25	< 25	28	33	40
900	-	< 25	< 25	28	34	41
1 000	-	< 25	< 25	29	34	41
1 100	-	< 25	< 25	29	35	42
1 200	-	< 25	25	30	35	42
1 300	-	< 25	26	30	36	42
1 400	-	< 25	26	30	36	43
1 500	-	< 25	26	31	36	43
1 600	-	< 25	27	31	37	43
1 700	-	< 25	27	31	37	43
1 800	-	< 25	27	31	37	44
1 900	-	< 25	27	32	37	44
2 000	-	< 25	28	32	38	44
2 100	-	< 25	28	32	38	44
2 200	-	25	28	32	38	45
2 300	-	25	28	33	38	45
2 400	-	25	29	33	39	45
2 500	-	25	29	33	39	45
2 600	-	25	29	33	39	45
2 700	-	26	29	33	39	45
2 800	-	26	29	34	39	46
2 900	-	26	30	34	40	46
3 000	-	26	30	34	40	46
3 200	-	26	30	34	40	46
3 400	-	27	30	34	40	46
3 600	-	27	31	35	41	47
3 800	-	27	31	35	41	47
4 000	-	27	31	35	41	47
4 200	-	28	31	35	41	47
4 400	-	28	32	36	42	48
4 600	-	28	32	36	42	48
4 800	-	28	32	36	42	48

Q[W] 55/45/20 °C (ΔT=30 °C)

Length L [mm]	Speed [-] / Heating output [W]					
	0 V	2 V	4 V	6 V	8 V	10 V
700	24	101	167	225	277	321
800	30	135	223	300	369	428
900	35	162	267	361	442	513
1 000	41	230	379	511	627	727
1 100	47	230	379	511	627	727
1 200	53	270	445	601	738	855
1 300	59	298	490	661	811	941
1 400	65	331	546	737	904	1 048
1 500	71	365	601	811	996	1 154
1 600	76	400	658	888	1 090	1 264
1 700	82	400	658	888	1 090	1 264
1 800	88	460	757	1 022	1 254	1 454
1 900	94	501	825	1 113	1 367	1 584
2 000	100	535	881	1 189	1 459	1 692
2 100	106	562	925	1 249	1 532	1 777
2 200	111	562	925	1 249	1 532	1 777
2 300	117	629	1 036	1 399	1 717	1 991
2 400	123	629	1 036	1 399	1 717	1 991
2 500	129	670	1 103	1 489	1 828	2 119
2 600	135	697	1 148	1 550	1 901	2 205
2 700	141	724	1 192	1 609	1 975	2 290
2 800	147	765	1 259	1 700	2 086	2 418
2 900	153	799	1 316	1 776	2 180	2 527
3 000	158	799	1 316	1 776	2 180	2 527
3 200	170	901	1 483	2 002	2 457	2 848
3 400	182	934	1 539	2 077	2 549	2 956
3 600	193	1 029	1 694	2 287	2 807	3 255
3 800	205	1 063	1 750	2 363	2 900	3 361
4 000	217	1 124	1 851	2 498	3 066	3 554
4 200	229	1 199	1 974	2 664	3 270	3 791
4 400	240	1 259	2 073	2 798	3 434	3 982
4 600	252	1 334	2 197	2 965	3 639	4 219
4 800	263	1 361	2 241	3 025	3 713	4 304

Fans input power [W]*

Length L [mm]	Number of fans	Speed [-] / Fans input power [W]*				
		2 V	4 V	6 V	8 V	10 V
700	1	1	1	1	2	2
800	1	1	1	1	2	2
900	1	1	1	2	2	2
1 000	1	1	1	2	2	3
1 100	1	1	1	2	2	3
1 200	2	2	2	2	3	4
1 300	2	2	2	3	3	4
1 400	2	2	2	3	3	5
1 500	2	2	2	3	4	5
1 600	1	1	1	2	3	5
1 700	2	2	2	3	4	5
1 800	2	2	2	3	4	5
1 900	2	2	2	3	4	6
2 000	2	2	2	3	4	7
2 100	2	2	2	3	4	7
2 200	2	2	2	3	4	7
2 300	2	2	2	3	4	7
2 400	2	2	2	3	4	7
2 500	3	3	3	4	6	9
2 600	3	3	3	4	6	9
2 700	3	3	3	4	6	9
2 800	3	3	3	4	6	9
2 900	2	2	2	3	5	9
3 000	3	3	3	4	6	9
3 200	3	3	3	4	6	11
3 400	3	3	3	4	6	11
3 600	3	3	3	5	6	12
3 800	4	3	4	6	7	13
4 000	4	3	4	6	8	13
4 200	3	3	3	5	7	13
4 400	4	3	4	6	8	14
4 600	4	3	4	6	8	15
4 800	4	3	4	6	8	15

* Approximate fan input powers / When using electrothermal actuator add in the trench heater's power 3 W

FRT 0080 0175

TRENCH HEATER WITH FAN



- › Flats, detached houses, offices, administrative buildings
- › Narrow and low trench heater
- › High heating output
- › Continuous speed control
- › Quiet operation
- › Common electricity consumption **2 W/m**
- › Using in dry environment



Technical data

Trench heater

Height [H]	80 mm
Width [W]	175 mm
Length [L]	700-4800 mm in step 100 mm

Heat exchanger

Type	Al-Cu lamellar
Length	L-295 mm
Connection thread	2xG1/2" inner

Working conditions

Max. temperature	110 °C
Max. overpressure	1 MPa (10 bar)
Protection	IP 20
Ambient conditions	Temp. T = +2 to +40 °C Humidity Rh = 20 to 70%

Trench heater standard equipment

Trough	Galvanized steel trough with surface finish and black spray layer inside, black cover plates of connection
Heat exchanger	Al-Cu lamellar exchanger with air vent valve, black painted
Grille	Design walkable grille according to the customer's choice
Ledge	Made of anodized aluminium, type and colour according to the customer's choice
Fan	Modern tangential fan with 24 V DC EC motor with high efficiency, rotors protection
Assembly elements	Leveling screws for setting up the trough, mounting brackets
Manual	Manual for the progress of work during installation and user manual
Wiring	Electrical wiring diagram of the trench heaters
Mounting board	Cover and the spacer particle board for easy installation
Package	Transport package for protection against damage during transportation and handling

Technical drawing

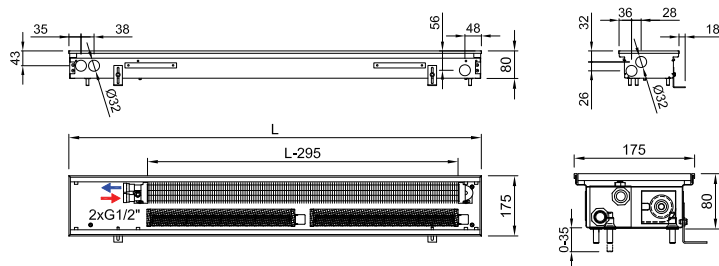

Connection to heating system

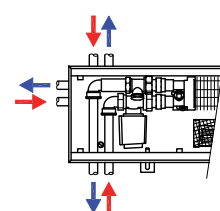

Accessories per order



Variants

Grilles



Transverse grilles - rigid

Peripheral ledge

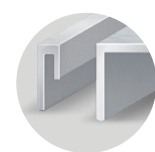

- ① Grilles → 6
 ② Ledges → 8
 ③ Acoustic power → 13
 ④ Accessories → 14
 ⑤ Hydraulic parameters → 126
 ⑥ Wiring → 129

Code example: FRT 0080 0175 1700 C 35 J3 L - 5

Trench heater **FRT** H=80 mm, W= 175 mm, L= 1700 mm, „C“ Galvanized steel trough with black inside, heat exchanger and inner parts painted black, „35“ low black anodized aluminium grille, transverse, rigid, „J3“ peripheral ledge „J“, black anodized aluminium „L“ water connection at the left side (when installing the heat exchanger closer to the window, fans to the room), „5“ 24 V DC fans without controller (controller is not needed)



Trench heater heating output FRT 0080 0175

Q[W] 75/65/20 °C (ΔT=50 °C)

Temperature exponent 1,1

Length L [mm]	Speed [-] / Heating output [W]					
	0 V	2 V	4 V	6 V	8 V	10 V
700	27	94	167	233	293	347
800	34	126	222	311	391	462
900	41	151	267	373	469	555
1 000	48	214	378	528	664	786
1 100	54	214	378	528	664	786
1 200	61	252	445	622	781	925
1 300	68	277	489	684	860	1 017
1 400	75	308	545	761	957	1 133
1 500	81	340	601	839	1 055	1 248
1 600	88	372	657	918	1 155	1 366
1 700	95	372	657	918	1 155	1 366
1 800	102	428	756	1 057	1 328	1 572
1 900	108	466	824	1 151	1 448	1 713
2 000	115	498	880	1 229	1 545	1 828
2 100	122	523	924	1 291	1 623	1 921
2 200	128	523	924	1 291	1 623	1 921
2 300	135	586	1 036	1 447	1 819	2 152
2 400	142	586	1 036	1 447	1 819	2 152
2 500	149	624	1 102	1 540	1 936	2 291
2 600	155	649	1 147	1 602	2 014	2 383
2 700	162	674	1 191	1 664	2 092	2 476
2 800	169	712	1 258	1 757	2 209	2 614
2 900	176	744	1 315	1 837	2 309	2 732
3 000	182	744	1 315	1 837	2 309	2 732
3 200	196	838	1 482	2 070	2 602	3 079
3 400	209	870	1 537	2 147	2 700	3 195
3 600	223	958	1 693	2 365	2 973	3 518
3 800	236	989	1 749	2 443	3 071	3 634
4 000	250	1 046	1 849	2 583	3 247	3 842
4 200	263	1 116	1 972	2 755	3 464	4 098
4 400	277	1 172	2 071	2 893	3 638	4 304
4 600	290	1 242	2 195	3 066	3 854	4 561
4 800	304	1 267	2 239	3 128	3 933	4 653

75/65/20 °C → 75°C inlet temperature, 65°C outlet temp., 20 °C room temp. / Output 90/70/20 °C = ~ 1,22 x 75/65/20 °C / Output 70/55/20 °C = ~ 0,84 x 75/65/20 °C / Heating outputs in accordance with EN 16430 / Not listed heating outputs for lengths per 100 mm steps calculate linearly. Exact values can be found at www.isan.cz

Acoustic power [dB(A)]

Length L [mm]	Speed [-] / Acoustic power [dB(A)]					
	0 V	2 V	4 V	6 V	8 V	10 V
700	-	< 25	< 25	< 25	29	35
800	-	< 25	< 25	26	30	35
900	-	< 25	< 25	26	30	36
1 000	-	< 25	< 25	27	31	36
1 100	-	< 25	< 25	27	31	37
1 200	-	< 25	< 25	27	31	37
1 300	-	< 25	< 25	27	31	37
1 400	-	< 25	< 25	28	32	38
1 500	-	< 25	< 25	28	32	38
1 600	-	< 25	< 25	28	32	38
1 700	-	< 25	< 25	28	32	38
1 800	-	< 25	< 25	28	33	39
1 900	-	< 25	25	29	33	39
2 000	-	< 25	25	29	33	39
2 100	-	< 25	25	29	33	39
2 200	-	< 25	26	29	33	39
2 300	-	< 25	26	29	33	39
2 400	-	< 25	26	29	34	40
2 500	-	< 25	26	29	34	40
2 600	-	< 25	26	29	34	40
2 700	-	< 25	26	30	34	40
2 800	-	< 25	26	30	34	40
2 900	-	< 25	26	30	34	40
3 000	-	< 25	26	30	34	40
3 200	-	< 25	27	30	35	41
3 400	-	< 25	27	30	35	41
3 600	-	< 25	27	31	35	41
3 800	-	25	27	31	35	41
4 000	-	25	27	31	36	42
4 200	-	25	28	31	36	42
4 400	-	26	28	31	36	42
4 600	-	26	28	31	36	42
4 800	-	26	28	32	36	42

Q[W] 55/45/20 °C (ΔT=30 °C)

Length L [mm]	Speed [-] / Heating output [W]					
	0 V	2 V	4 V	6 V	8 V	10 V
700	13	54	95	133	167	198
800	16	72	127	177	223	263
900	20	86	152	213	267	316
1 000	23	122	216	301	379	448
1 100	26	122	216	301	379	448
1 200	30	144	254	355	445	527
1 300	33	158	279	390	490	580
1 400	36	176	311	434	546	646
1 500	39	194	343	478	601	712
1 600	43	212	375	523	658	779
1 700	46	212	375	523	658	779
1 800	49	244	431	603	757	896
1 900	52	266	470	656	826	977
2 000	56	284	502	701	881	1 042
2 100	59	298	527	736	925	1 095
2 200	62	298	527	736	925	1 095
2 300	65	334	591	825	1 037	1 227
2 400	69	334	591	825	1 037	1 227
2 500	72	356	628	878	1 104	1 306
2 600	75	370	654	913	1 148	1 359
2 700	78	384	679	949	1 193	1 412
2 800	82	406	717	1 002	1 259	1 490
2 900	85	424	750	1 047	1 316	1 558
3 000	88	424	750	1 047	1 316	1 558
3 200	95	478	845	1 180	1 483	1 755
3 400	101	496	876	1 224	1 539	1 822
3 600	108	546	965	1 348	1 695	2 006
3 800	114	564	997	1 393	1 751	2 072
4 000	121	596	1 054	1 473	1 851	2 190
4 200	127	636	1 124	1 571	1 975	2 336
4 400	134	668	1 181	1 649	2 074	2 454
4 600	140	708	1 251	1 748	2 197	2 600
4 800	147	722	1 276	1 783	2 242	2 653

Fans input power [W]*

Length L [mm]	Number of fans	Speed [-] / Fans input power [W]*				
		2 V	4 V	6 V	8 V	10 V
700	1	1	1	1	2	2
800	1	1	1	1	2	2
900	1	1	1	2	2	2
1 000	1	1	1	2	2	3
1 100	1	1	1	2	2	3
1 200	2	2	2	2	3	4
1 300	2	2	2	3	3	4
1 400	2	2	2	3	3	5
1 500	2	2	2	3	4	5
1 600	1	1	1	2	3	5
1 700	2	2	2	3	4	5
1 800	2	2	2	3	4	5
1 900	2	2	2	3	4	6
2 000	2	2	2	3	4	7
2 100	2	2	2	3	4	7
2 200	2	2	2	3	4	7
2 300	2	2	2	3	4	7
2 400	2	2	2	3	4	7
2 500	3	3	3	4	6	9
2 600	3	3	3	4	6	9
2 700	3	3	3	4	6	9
2 800	3	3	3	4	6	9
2 900	2	2	2	3	5	9
3 000	3	3	3	4	6	9
3 200	3	3	3	4	6	11
3 400	3	3	3	4	6	11
3 600	3	3	3	5	6	12
3 800	4	3	4	6	7	13
4 000	4	3	4	6	8	13
4 200	3	3	3	5	7	13
4 400	4	3	4	6	8	14
4 600	4	3	4	6	8	15
4 800	4	3	4	6	8	15

* Approximate fan input powers / When using electrothermal actuator add in the trench heater's power 3 W

FRT 0080 0200

TRENCH HEATER WITH FAN



- › Flats, detached houses, offices, administrative buildings
- › Small universal trench heater
- › High heating output
- › Continuous speed control
- › Quiet operation
- › Common electricity consumption **2 W/m**
- › Using in dry environment



Technical data

Trench heater

Height [H]	80 mm
Width [W]	200 mm
Length [L]	700-4800 mm in step 100 mm

Heat exchanger

Type	Al-Cu lamellar
Length	L-295 mm
Connection thread	2xG1/2" inner

Working conditions

Max. temperature	110 °C
Max. overpressure	1 MPa (10 bar)
Protection	IP 20
Ambient conditions	Temp. T = +2 to +40 °C Humidity Rh = 20 to 70%

Trench heater standard equipment

Trough	Galvanized steel trough with surface finish and black spray layer inside, black cover plates of connection
Heat exchanger	Al-Cu lamellar exchanger with air vent valve, black painted
Grille	Design walkable grille according to the customer's choice
Ledge	Made of anodized aluminium, type and colour according to the customer's choice
Fan	Modern tangential fan with 24 V DC EC motor with high efficiency
Assembly elements	Leveling screws for setting up the trough, mounting brackets
Manual	Manual for the progress of work during installation and user manual
Wiring	Electrical wiring diagram of the trench heaters
Mounting board	Cover and the spacer particle board for easy installation
Package	Transport package for protection against damage during transportation and handling

Technical drawing

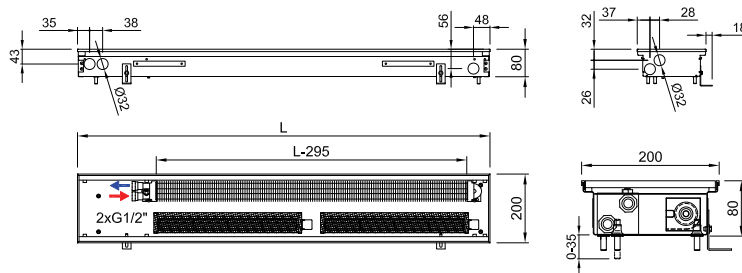

Connection to heating system

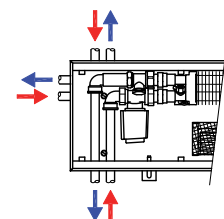

Accessories per order



Variants

Grilles



Transverse grilles - rigid

Peripheral ledge

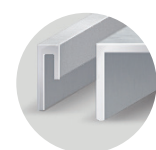

- ① Grilles → 6
 ② Ledges → 8
 ③ Acoustic power → 13
 ④ Accessories → 14
 ⑤ Hydraulic parameters → 126
 ⑥ Wiring → 129

Code example: FRT 0080 0200 1900 C 15 L1 L - 5

Trench heater **FRT** H=80 mm, W= 200 mm, L= 1900 mm, „C” Galvanized steel trough with black inside, heat exchanger and inner parts painted black, „15” Low natural anodized aluminium grille, transverse, rigid, „L1” peripheral ledge „L” with an overlap, natur anodized aluminium „L” water connection at the left side (when installing the heat exchanger closer to the window, fans to the room), „5” 24 V DC fans without controller (controller is not needed)



Trench heater heating output FRT 0080 0200

Q[W] 75/65/20 °C (ΔT=50 °C)

Temperature exponent 1,1

Length L [mm]	Speed [-] / Heating output [W]					
	0 V	2 V	4 V	6 V	8 V	10 V
700	44	154	200	251	309	371
800	55	205	266	335	411	495
900	66	246	320	402	494	594
1 000	77	348	453	570	699	841
1 100	88	348	453	570	699	841
1 200	99	410	533	671	823	990
1 300	110	451	586	738	905	1 089
1 400	121	502	653	821	1 008	1 212
1 500	131	553	719	905	1 111	1 336
1 600	142	605	787	991	1 216	1 462
1 700	153	605	787	991	1 216	1 462
1 800	164	696	906	1 140	1 399	1 683
1 900	175	759	987	1 242	1 524	1 833
2 000	186	810	1 054	1 326	1 627	1 957
2 100	197	851	1 107	1 393	1 709	2 056
2 200	208	851	1 107	1 393	1 709	2 056
2 300	219	953	1 240	1 561	1 915	2 304
2 400	230	953	1 240	1 561	1 915	2 304
2 500	241	1 015	1 320	1 661	2 039	2 452
2 600	251	1 056	1 373	1 728	2 121	2 551
2 700	262	1 097	1 427	1 795	2 203	2 650
2 800	273	1 158	1 506	1 896	2 327	2 798
2 900	284	1 210	1 574	1 981	2 431	2 925
3 000	295	1 210	1 574	1 981	2 431	2 925
3 200	317	1 364	1 774	2 233	2 740	3 296
3 400	339	1 415	1 841	2 317	2 843	3 420
3 600	361	1 559	2 027	2 551	3 131	3 766
3 800	382	1 610	2 094	2 635	3 234	3 890
4 000	404	1 702	2 214	2 786	3 419	4 112
4 200	426	1 816	2 362	2 972	3 647	4 387
4 400	448	1 907	2 480	3 121	3 830	4 607
4 600	470	2 020	2 628	3 307	4 059	4 882
4 800	491	2 061	2 681	3 374	4 141	4 981

75/65/20 °C → 75 °C inlet temperature, 65 °C outlet temp., 20 °C room temp. / Output 90/70/20 °C = ~ 1,22 x 75/65/20 °C / Output 70/55/20 °C = ~ 0,84 x 75/65/20 °C / Heating outputs in accordance with EN 16430 / Not listed heating outputs for lengths per 100 mm steps calculate linearly. Exact values can be found at www.isan.cz

Q[W] 55/45/20 °C (ΔT=30 °C)

Length L [mm]	Speed [-] / Heating output [W]					
	0 V	2 V	4 V	6 V	8 V	10 V
700	21	88	114	143	176	212
800	27	117	152	191	234	282
900	32	140	182	229	282	339
1 000	37	198	258	325	399	479
1 100	43	198	258	325	399	479
1 200	48	234	304	383	469	564
1 300	53	257	334	421	516	621
1 400	59	286	372	468	575	691
1 500	63	315	410	516	633	762
1 600	69	345	449	565	693	834
1 700	74	345	449	565	693	834
1 800	79	397	517	650	798	960
1 900	85	433	563	708	869	1 045
2 000	90	462	601	756	928	1 116
2 100	95	485	631	794	974	1 172
2 200	101	485	631	794	974	1 172
2 300	106	543	707	890	1 092	1 314
2 400	111	543	707	890	1 092	1 314
2 500	117	579	753	947	1 162	1 398
2 600	122	602	783	985	1 209	1 454
2 700	127	625	814	1 023	1 256	1 511
2 800	132	660	859	1 081	1 327	1 595
2 900	137	690	897	1 129	1 386	1 668
3 000	143	690	897	1 129	1 386	1 668
3 200	153	778	1 011	1 273	1 562	1 879
3 400	164	807	1 050	1 321	1 621	1 950
3 600	175	889	1 156	1 454	1 785	2 147
3 800	185	918	1 194	1 502	1 844	2 218
4 000	196	970	1 262	1 588	1 949	2 344
4 200	206	1 035	1 347	1 694	2 079	2 501
4 400	217	1 087	1 414	1 779	2 184	2 627
4 600	228	1 152	1 498	1 885	2 314	2 783
4 800	238	1 175	1 528	1 924	2 361	2 840

Acoustic power [dB(A)]

Length L [mm]	Speed [-] / Acoustic power [dB(A)]					
	0 V	2 V	4 V	6 V	8 V	10 V
700	-	< 25	< 25	26	30	36
800	-	< 25	< 25	26	31	37
900	-	< 25	< 25	27	31	37
1 000	-	< 25	< 25	27	32	38
1 100	-	< 25	< 25	28	32	38
1 200	-	< 25	< 25	28	32	38
1 300	-	< 25	< 25	28	33	39
1 400	-	< 25	25	29	33	39
1 500	-	< 25	25	29	33	39
1 600	-	< 25	26	29	34	40
1 700	-	< 25	26	29	34	40
1 800	-	< 25	26	29	34	40
1 900	-	< 25	26	30	34	40
2 000	-	< 25	26	30	35	41
2 100	-	< 25	26	30	35	41
2 200	-	< 25	27	30	35	41
2 300	-	< 25	27	30	35	41
2 400	-	< 25	27	31	35	41
2 500	-	< 25	27	31	35	41
2 600	-	25	27	31	36	42
2 700	-	25	27	31	36	42
2 800	-	25	27	31	36	42
2 900	-	25	27	31	36	42
3 000	-	25	28	31	36	42
3 200	-	26	28	32	36	42
3 400	-	26	28	32	37	43
3 600	-	26	28	32	37	43
3 800	-	26	28	32	37	43
4 000	-	26	29	32	37	43
4 200	-	26	29	33	38	44
4 400	-	27	29	33	38	44
4 600	-	27	29	33	38	44
4 800	-	27	29	33	38	44

Fans input power [W]*

Length L [mm]	Number of fans	Speed [-] / Fans input power [W]*				
		2 V	4 V	6 V	8 V	10 V
700	1	1	1	1	2	2
800	1	1	1	1	2	2
900	1	1	1	2	2	2
1 000	1	1	1	2	2	3
1 100	1	1	1	2	2	3
1 200	2	2	2	2	3	4
1 300	2	2	2	3	3	4
1 400	2	2	2	3	3	5
1 500	2	2	2	3	4	5
1 600	1	1	1	2	3	5
1 700	2	2	2	3	4	5
1 800	2	2	2	3	4	5
1 900	2	2	2	3	4	6
2 000	2	2	2	3	4	7
2 100	2	2	2	3	4	7
2 200	2	2	2	3	4	7
2 300	2	2	2	3	4	7
2 400	2	2	2	3	4	7
2 500	3	3	3	4	6	9
2 600	3	3	3	4	6	9
2 700	3	3	3	4	6	9
2 800	3	3	3	4	6	9
2 900	2	2	2	3	5	9
3 000	3	3	3	4	6	9
3 200	3	3	3	4	6	11
3 400	3	3	3	4	6	11
3 600	3	3	3	5	6	12
3 800	4	3	4	6	7	13
4 000	4	3	4	6	8	13
4 200	3	3	3	5	7	13
4 400	4	3	4	6	8	14
4 600	4	3	4	6	8	15
4 800	4	3	4	6	8	15

* Approximate fan input powers / When using electrothermal actuator add in the trench heater's power 3 W

FRT 0080 0250

TRENCH HEATER WITH FAN



- › Flats, detached houses, offices, administrative buildings
- › Small universal trench heater
- › High heating output
- › Continuous speed control
- › Quiet operation
- › Common electricity consumption **2 W/m**
- › Using in dry environment

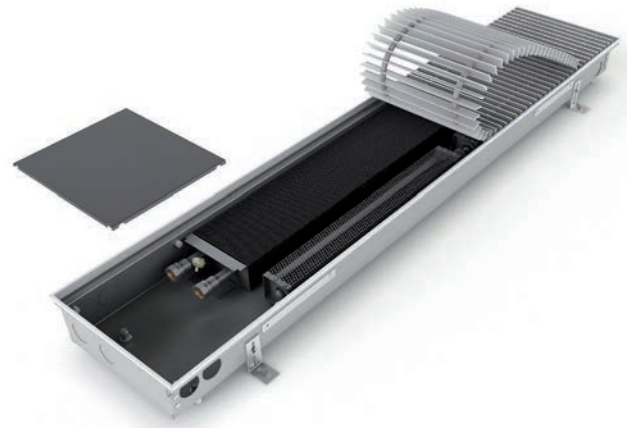

Technical data

Trench heater

Height [H]	80 mm
Width [W]	250 mm
Length [L]	700-4800 mm in step 100 mm

Heat exchanger

Type	Al-Cu lamellar
Length	L-295 mm
Connection thread	2xG1/2" inner

Working conditions

Max. temperature	110 °C
Max. overpressure	1 MPa (10 bar)
Protection	IP 20
Ambient conditions	Temp. T = +2 to +40 °C Humidity Rh = 20 to 70%

Trench heater standard equipment

Trough	Galvanized steel trough with surface finish and black spray layer inside, black cover plates of connection
Heat exchanger	Al-Cu lamellar exchanger with air vent valve, black painted
Grille	Design walkable grille according to the customer's choice
Ledge	Made of anodized aluminium, type and colour according to the customer's choice
Fan	Modern tangential fan with 24 V DC EC motor with high efficiency
Assembly elements	Leveling screws for setting up the trough, mounting brackets
Manual	Manual for the progress of work during installation and user manual
Wiring	Electrical wiring diagram of the trench heaters
Mounting board	Cover and the spacer particle board for easy installation
Package	Transport package for protection against damage during transportation and handling

Technical drawing

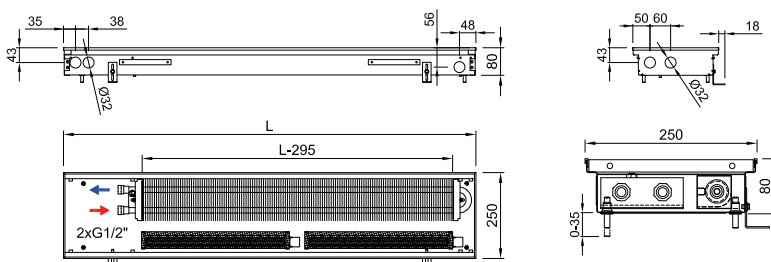

Connection to heating system

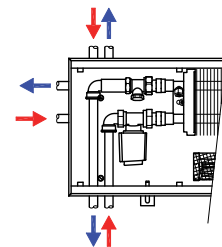

Accessories per order



Variants

Grilles

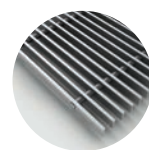

Transverse roll-up

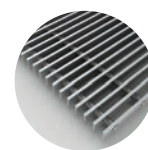

Linear non-rolling

Peripheral ledge



① Grilles → 6 ② Ledges → 8 ③ Acoustic power → 13 ④ Accessories → 14 ⑤ Hydraulic parameters → 126 ⑥ Wiring → 129

Code example: FRT 0080 0250 0900 C 12 J1 L - 5

Trench heater FRT H= 80 mm, W= 250 mm, L=900 mm, „C” Galvanized steel trough with black inside, heat exchanger and inner parts painted black, „12” natur anodized aluminium grille, linear, rigid „J1” peripheral ledge „J”, natur anodized aluminium, „L” water connection at the left side (when installing the heat exchanger closer to the window, fans to the room), „5” 24 V DC fans without controller (controller is not needed)



Trench heater heating output FRT 0080 0250

Q[W] 75/65/20 °C (ΔT=50 °C)

Temperature exponent 1,1

Length L [mm]	Speed [-] / Heating output [W]					
	0 V	2 V	4 V	6 V	8 V	10 V
700	51	162	274	374	463	541
800	63	215	365	499	618	722
900	76	258	438	599	742	866
1 000	88	366	620	848	1 050	1 227
1 100	101	366	620	848	1 050	1 227
1 200	113	431	730	998	1 236	1 443
1 300	126	474	803	1 098	1 359	1 587
1 400	138	528	894	1 223	1 514	1 768
1 500	151	581	985	1 347	1 668	1 948
1 600	163	636	1 078	1 475	1 826	2 132
1 700	176	636	1 078	1 475	1 826	2 132
1 800	188	732	1 240	1 697	2 101	2 453
1 900	201	798	1 352	1 849	2 289	2 673
2 000	213	852	1 443	1 974	2 444	2 854
2 100	225	895	1 516	2 073	2 568	2 998
2 200	238	895	1 516	2 073	2 568	2 998
2 300	250	1 002	1 698	2 323	2 876	3 359
2 400	263	1 002	1 698	2 323	2 876	3 359
2 500	275	1 067	1 808	2 473	3 062	3 575
2 600	288	1 110	1 881	2 572	3 185	3 720
2 700	300	1 153	1 954	2 672	3 309	3 864
2 800	313	1 218	2 063	2 822	3 494	4 080
2 900	325	1 273	2 156	2 949	3 652	4 264
3 000	338	1 273	2 156	2 949	3 652	4 264
3 200	363	1 434	2 430	3 324	4 115	4 806
3 400	388	1 488	2 521	3 448	4 270	4 986
3 600	413	1 639	2 776	3 798	4 703	5 491
3 800	438	1 693	2 868	3 922	4 857	5 671
4 000	463	1 790	3 032	4 147	5 135	5 996
4 200	488	1 909	3 234	4 424	5 478	6 397
4 400	513	2 005	3 397	4 646	5 753	6 718
4 600	538	2 125	3 599	4 923	6 096	7 118
4 800	563	2 168	3 672	5 023	6 220	7 263

75/65/20 °C → 75 °C inlet temperature, 65 °C outlet temp., 20 °C room temp. / Output 90/70/20 °C = ~ 1,22 x 75/65/20 °C / Output 70/55/20 °C = ~ 0,84 x 75/65/20 °C / Heating outputs in accordance with EN 16430 / Not listed heating outputs for lengths per 100 mm steps calculate linearly. Exact values can be found at www.isan.cz

Acoustic power [dB(A)]

Length L [mm]	Speed [-] / Acoustic power [dB(A)]					
	0 V	2 V	4 V	6 V	8 V	10 V
700	-	< 25	< 25	27	32	39
800	-	< 25	< 25	27	33	40
900	-	< 25	< 25	28	33	40
1 000	-	< 25	< 25	28	34	41
1 100	-	< 25	< 25	29	34	41
1 200	-	< 25	25	29	35	41
1 300	-	< 25	25	30	35	42
1 400	-	< 25	26	30	36	42
1 500	-	< 25	26	30	36	42
1 600	-	< 25	26	31	36	43
1 700	-	< 25	26	31	36	43
1 800	-	< 25	27	31	37	43
1 900	-	< 25	27	31	37	43
2 000	-	< 25	27	32	37	44
2 100	-	< 25	27	32	37	44
2 200	-	< 25	28	32	38	44
2 300	-	< 25	28	32	38	44
2 400	-	< 25	28	32	38	44
2 500	-	25	28	33	38	45
2 600	-	25	29	33	39	45
2 700	-	25	29	33	39	45
2 800	-	25	29	33	39	45
2 900	-	26	29	33	39	45
3 000	-	26	29	33	39	45
3 200	-	26	30	34	40	46
3 400	-	26	30	34	40	46
3 600	-	27	30	34	40	46
3 800	-	27	30	35	40	46
4 000	-	27	31	35	41	47
4 200	-	27	31	35	41	47
4 400	-	27	31	35	41	47
4 600	-	28	31	35	41	47
4 800	-	28	31	36	41	47

Q[W] 55/45/20 °C (ΔT=30 °C)

Length L [mm]	Speed [-] / Heating output [W]					
	0 V	2 V	4 V	6 V	8 V	10 V
700	25	92	156	213	264	308
800	31	123	208	284	352	412
900	37	147	250	342	423	494
1 000	43	209	353	483	599	700
1 100	49	209	353	483	599	700
1 200	55	246	416	569	705	823
1 300	61	270	458	626	775	905
1 400	67	301	510	697	863	1 008
1 500	73	331	562	768	951	1 111
1 600	79	363	615	841	1 041	1 215
1 700	85	363	615	841	1 041	1 215
1 800	91	417	707	967	1 198	1 399
1 900	97	455	771	1 054	1 305	1 524
2 000	103	486	823	1 125	1 393	1 627
2 100	109	510	864	1 182	1 464	1 709
2 200	115	510	864	1 182	1 464	1 709
2 300	121	571	968	1 324	1 640	1 915
2 400	127	571	968	1 324	1 640	1 915
2 500	133	608	1 031	1 410	1 746	2 038
2 600	139	633	1 072	1 466	1 816	2 121
2 700	145	657	1 114	1 523	1 887	2 203
2 800	152	694	1 176	1 609	1 992	2 326
2 900	157	726	1 229	1 681	2 082	2 431
3 000	164	726	1 229	1 681	2 082	2 431
3 200	176	818	1 385	1 895	2 346	2 740
3 400	188	848	1 437	1 966	2 434	2 843
3 600	200	934	1 583	2 165	2 681	3 131
3 800	212	965	1 635	2 236	2 769	3 233
4 000	224	1 021	1 729	2 364	2 928	3 418
4 200	236	1 088	1 844	2 522	3 123	3 647
4 400	248	1 143	1 937	2 649	3 280	3 830
4 600	260	1 212	2 052	2 807	3 475	4 058
4 800	273	1 236	2 093	2 864	3 546	4 141

Fans input power [W]*

Length L [mm]	Number of fans	Speed [-] / Fans input power [W]*				
		2 V	4 V	6 V	8 V	10 V
700	1	1	1	1	2	2
800	1	1	1	1	2	2
900	1	1	1	2	2	2
1 000	1	1	1	2	2	3
1 100	1	1	1	2	2	3
1 200	2	2	2	2	3	4
1 300	2	2	2	3	3	4
1 400	2	2	2	3	3	5
1 500	2	2	2	3	4	5
1 600	1	1	1	2	3	5
1 700	2	2	2	3	4	5
1 800	2	2	2	3	4	5
1 900	2	2	2	3	4	6
2 000	2	2	2	3	4	7
2 100	2	2	2	3	4	7
2 200	2	2	2	3	4	7
2 300	2	2	2	3	4	7
2 400	2	2	2	3	4	7
2 500	3	3	3	4	6	9
2 600	3	3	3	4	6	9
2 700	3	3	3	4	6	9
2 800	3	3	3	4	6	9
2 900	2	2	2	3	5	9
3 000	3	3	3	4	6	9
3 200	3	3	3	4	6	11
3 400	3	3	3	4	6	11
3 600	3	3	3	5	6	12
3 800	4	3	4	6	7	13
4 000	4	3	4	6	8	13
4 200	3	3	3	5	7	13
4 400	4	3	4	6	8	14
4 600	4	3	4	6	8	15
4 800	4	3	4	6	8	15

* Approximate fan input powers / When using electrothermal actuator add in the trench heater's power 3 W

FRT 0080 0300

TRENCH HEATER WITH FAN



- › Flats, detached houses, offices, administrative buildings
- › Low trench heater with a good heating output
- › High heating output
- › Continuous speed control
- › Quiet operation
- › Common electricity consumption **2 W/m**
- › Using in dry environment

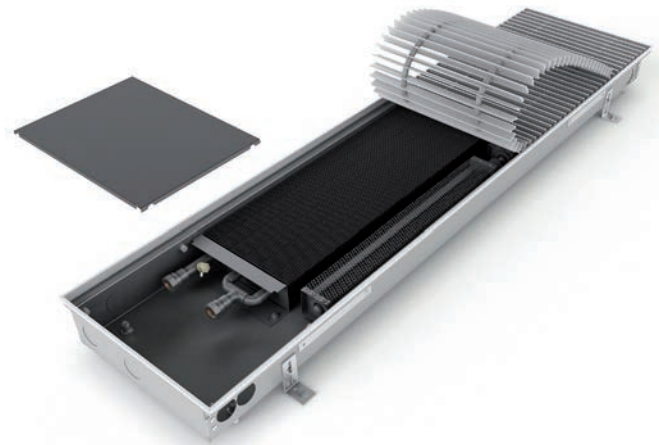

Technical data

Trench heater

Height [H]	80 mm
Width [W]	300 mm
Length [L]	700-4800 mm in step 100 mm

Heat exchanger

Type	Al-Cu lamellar
Length	L-295 mm
Connection thread	2xG1/2" inner

Working conditions

Max. temperature	110 °C
Max. overpressure	1 MPa (10 bar)
Protection	IP 20
Ambient conditions	Temp. T = +2 to +40 °C Humidity Rh = 20 to 70%

Trench heater standard equipment

Trough	Galvanized steel trough with surface finish and black spray layer inside, black cover plates of connection
Heat exchanger	Al-Cu lamellar exchanger with air vent valve, black painted
Grille	Design walkable grille according to the customer's choice (stainless grilles surcharge)
Ledge	Made of anodized aluminium, type and colour according to the customer's choice
Fan	Modern tangential fan with 24 V DC EC motor with high efficiency, rotors protection
Assembly elements	Leveling screws for setting up the trough, mounting brackets
Manual	Manual for the progress of work during installation and user manual
Wiring	Electrical wiring diagram of the trench heaters
Mounting board	Cover and the spacer particle board for easy installation
Package	Transport package for protection against damage during transportation and handling

Technical drawing

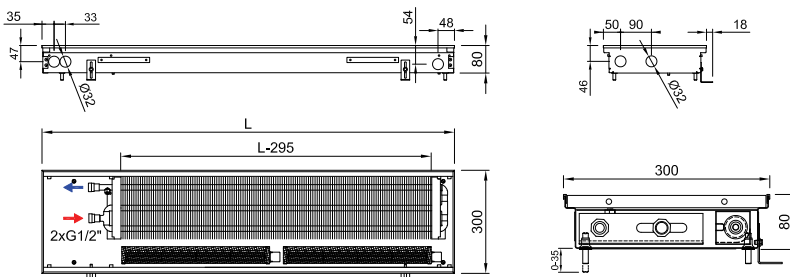

Connection to heating system

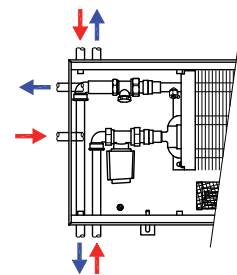

Accessories per order



Variants

Grilles

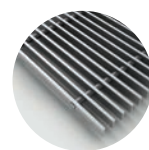

Transverse roll-up

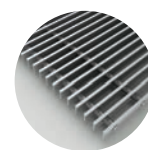

Linear non-rolling

Peripheral ledge



- ① Grilles → 6
 ② Ledges → 8
 ③ Acoustic power → 13
 ④ Accessories → 14
 ⑤ Hydraulic parameters → 126
 ⑥ Wiring → 129

Code example: FRT 0080 0300 2200 C 21 J2 R - 5

Trench heater FRT H = 80 mm, W = 300 mm, L = 2 200 mm, „C” Galvanized steel trough with black inside, heat exchanger and inner parts painted black, „21” bronze anodized aluminium grille, transverse, roll-up „J2” peripheral ledge „J”, bronze anodized aluminium, „R” water connection at the right side (when installing the heat exchanger closer to the window, fans to the room), „5” 24 V DC fans without controller (controller is not needed)



Trench heater heating output FRT 0080 0300

Q[W] 75/65/20 °C (ΔT=50 °C)

Temperature exponent 1,1

Length L [mm]	Speed [-] / Heating output [W]					
	0 V	2 V	4 V	6 V	8 V	10 V
700	59	189	311	422	524	615
800	74	252	414	563	698	820
900	88	302	497	676	838	984
1 000	103	428	704	957	1 187	1 394
1 100	118	428	704	957	1 187	1 394
1 200	132	503	828	1 126	1 397	1 640
1 300	147	553	911	1 239	1 537	1 804
1 400	161	616	1 015	1 380	1 711	2 009
1 500	176	679	1 118	1 521	1 886	2 214
1 600	191	743	1 224	1 664	2 064	2 423
1 700	205	743	1 224	1 664	2 064	2 423
1 800	220	855	1 408	1 915	2 375	2 788
1 900	234	932	1 535	2 087	2 588	3 038
2 000	249	995	1 638	2 227	2 762	3 243
2 100	264	1 045	1 721	2 340	2 902	3 407
2 200	278	1 045	1 721	2 340	2 902	3 407
2 300	293	1 171	1 928	2 622	3 251	3 817
2 400	307	1 171	1 928	2 622	3 251	3 817
2 500	322	1 247	2 052	2 790	3 461	4 063
2 600	337	1 297	2 135	2 903	3 600	4 227
2 700	351	1 347	2 218	3 016	3 740	4 391
2 800	366	1 423	2 342	3 185	3 950	4 637
2 900	380	1 487	2 448	3 328	4 128	4 846
3 000	395	1 487	2 448	3 328	4 128	4 846
3 200	424	1 675	2 759	3 751	4 652	5 461
3 400	453	1 738	2 862	3 891	4 826	5 666
3 600	483	1 914	3 152	4 286	5 315	6 240
3 800	512	1 977	3 256	4 426	5 490	6 445
4 000	541	2 091	3 442	4 680	5 804	6 814
4 200	570	2 230	3 672	4 992	6 192	7 269
4 400	599	2 342	3 856	5 243	6 502	7 634
4 600	629	2 482	4 086	5 556	6 890	8 089
4 800	658	2 532	4 169	5 668	7 030	8 253

75/65/20 °C → 75 °C inlet temperature, 65 °C outlet temp., 20 °C room temp. / Output 90/70/20 °C = ~ 1,22 x 75/65/20 °C / Output 70/55/20 °C = ~ 0,84 x 75/65/20 °C / Heating outputs in accordance with EN 16430 / Not listed heating outputs for lengths per 100 mm steps calculate linearly. Exact values can be found at www.isan.cz

Acoustic power [dB(A)]

Length L [mm]	Speed [-] / Acoustic power [dB(A)]					
	0 V	2 V	4 V	6 V	8 V	10 V
700	-	< 25	< 25	27	33	40
800	-	< 25	< 25	28	33	40
900	-	< 25	< 25	28	34	41
1 000	-	< 25	< 25	29	34	41
1 100	-	< 25	< 25	29	35	42
1 200	-	< 25	25	30	35	42
1 300	-	< 25	26	30	36	42
1 400	-	< 25	26	30	36	43
1 500	-	< 25	26	31	36	43
1 600	-	< 25	27	31	37	43
1 700	-	< 25	27	31	37	43
1 800	-	< 25	27	31	37	44
1 900	-	< 25	27	32	37	44
2 000	-	< 25	28	32	38	44
2 100	-	< 25	28	32	38	44
2 200	-	25	28	32	38	45
2 300	-	25	28	33	38	45
2 400	-	25	29	33	39	45
2 500	-	25	29	33	39	45
2 600	-	25	29	33	39	45
2 700	-	26	29	33	39	45
2 800	-	26	29	34	39	46
2 900	-	26	30	34	40	46
3 000	-	26	30	34	40	46
3 200	-	26	30	34	40	46
3 400	-	27	30	34	40	46
3 600	-	27	31	35	41	47
3 800	-	27	31	35	41	47
4 000	-	27	31	35	41	47
4 200	-	28	31	35	41	47
4 400	-	28	32	36	42	48
4 600	-	28	32	36	42	48
4 800	-	28	32	36	42	48

Q[W] 55/45/20 °C (ΔT=30 °C)

Length L [mm]	Speed [-] / Heating output [W]					
	0 V	2 V	4 V	6 V	8 V	10 V
700	29	108	177	241	299	351
800	36	144	236	321	398	467
900	43	172	283	385	478	561
1 000	50	244	401	546	677	795
1 100	57	244	401	546	677	795
1 200	64	287	472	642	796	935
1 300	71	315	519	706	876	1 028
1 400	78	351	579	787	975	1 145
1 500	85	387	637	867	1 075	1 262
1 600	92	424	698	949	1 177	1 381
1 700	99	424	698	949	1 177	1 381
1 800	107	487	803	1 092	1 354	1 589
1 900	113	531	875	1 190	1 475	1 732
2 000	121	567	934	1 270	1 575	1 849
2 100	128	596	981	1 334	1 654	1 942
2 200	135	596	981	1 334	1 654	1 942
2 300	142	668	1 099	1 495	1 853	2 176
2 400	149	668	1 099	1 495	1 853	2 176
2 500	156	711	1 170	1 591	1 973	2 316
2 600	163	739	1 217	1 655	2 052	2 410
2 700	170	768	1 265	1 719	2 132	2 503
2 800	177	811	1 335	1 816	2 252	2 644
2 900	184	848	1 396	1 897	2 353	2 763
3 000	191	848	1 396	1 897	2 353	2 763
3 200	205	955	1 573	2 139	2 652	3 113
3 400	219	991	1 632	2 218	2 751	3 230
3 600	234	1 091	1 797	2 444	3 030	3 558
3 800	248	1 127	1 856	2 523	3 130	3 674
4 000	262	1 192	1 962	2 668	3 309	3 885
4 200	276	1 271	2 093	2 846	3 530	4 144
4 400	290	1 335	2 198	2 989	3 707	4 352
4 600	305	1 415	2 330	3 168	3 928	4 612
4 800	319	1 444	2 377	3 231	4 008	4 705

Fans input power [W]*

Length L [mm]	Number of fans	Speed [-] / Fans input power [W]*				
		2 V	4 V	6 V	8 V	10 V
700	1	1	1	1	2	2
800	1	1	1	1	2	2
900	1	1	1	2	2	2
1 000	1	1	1	2	2	3
1 100	1	1	1	2	2	3
1 200	2	2	2	2	3	4
1 300	2	2	2	3	3	4
1 400	2	2	2	3	3	5
1 500	2	2	2	3	4	5
1 600	1	1	1	2	3	5
1 700	2	2	2	3	4	5
1 800	2	2	2	3	4	5
1 900	2	2	2	3	4	6
2 000	2	2	2	3	4	7
2 100	2	2	2	3	4	7
2 200	2	2	2	3	4	7
2 300	2	2	2	3	4	7
2 400	2	2	2	3	4	7
2 500	3	3	3	4	6	9
2 600	3	3	3	4	6	9
2 700	3	3	3	4	6	9
2 800	3	3	3	4	6	9
2 900	2	2	2	3	5	9
3 000	3	3	3	4	6	9
3 200	3	3	3	4	6	11
3 400	3	3	3	4	6	11
3 600	3	3	3	5	6	12
3 800	4	3	4	6	7	13
4 000	4	3	4	6	8	13
4 200	3	3	3	5	7	13
4 400	4	3	4	6	8	14
4 600	4	3	4	6	8	15
4 800	4	3	4	6	8	15

* Approximate fan input powers / When using electrothermal actuator add in the trench heater's power 3 W

FRT 0090 0175

TRENCH HEATER WITH FAN



- › Flats, detached houses, offices, administrative buildings
- › Small narrow trench heater
- › High heating output
- › Continuous speed control
- › Quiet operation
- › Common electricity consumption **2 W/m**
- › Using in dry environment

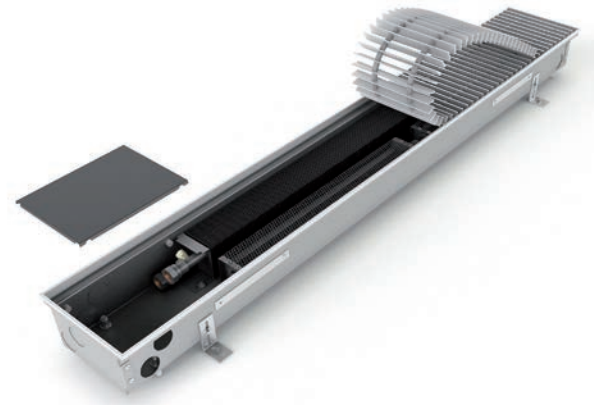

Technical data

Trench heater

Height [H]	90 mm
Width [W]	175 mm
Length [L]	700-4800 mm in step 100 mm

Heat exchanger

Type	Al-Cu lamellar
Length	L-295 mm
Connection thread	2×G1/2" inner

Working conditions

Max. temperature	110 °C
Max. overpressure	1 MPa (10 bar)
Protection	IP 20
Ambient conditions	Temp. T = +2 to +40 °C Humidity Rh = 20 to 70%

Trench heater standard equipment

Trough	Galvanized steel trough with surface finish and black spray layer inside, black cover plates of connection
Heat exchanger	Al-Cu lamellar exchanger with air vent valve, black painted
Grille	Design walkable grille according the customer's choice (stainless grilles surcharge)
Ledge	Made of anodized aluminium, type and colour according the customer's choice
Fan	Modern tangential fan with 24 V DC EC motor with high efficiency, rotors protection
Assembly elements	Leveling screws for setting up the trough, mounting brackets
Manual	Manual for the progress of work during installation and user manual
Wiring	Electrical wiring diagram of the trench heaters
Mounting board	Cover and the spacer particle board for easy installation
Package	Transport package for protection against damage during transportation and handling

Technical drawing

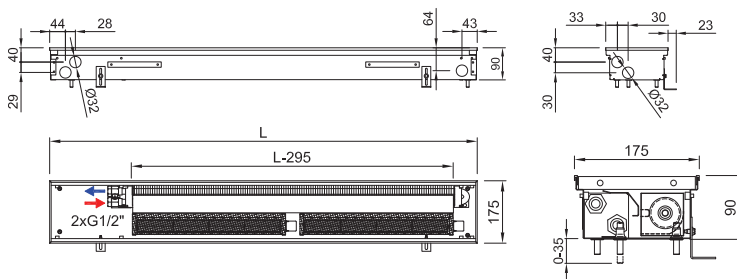

Connection to heating system

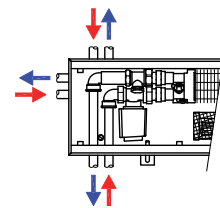

Accessories per order



Variants

Grilles

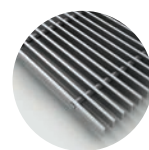

Transverse roll-up

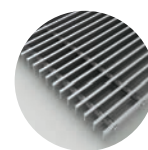

Linear non-rolling

Peripheral ledge

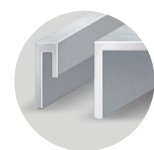

- ① Grilles → 6
 ② Ledges → 8
 ③ Acoustic power → 13
 ④ Accessories → 14
 ⑤ Hydraulic parameters → 126
 ⑥ Wiring → 129

Code example: FRT 0090 0175 1400 C 63 L1 L - 5

Trench heater FRT H=90 mm, W= 175 mm, L=1 400 mm, „C“ Galvanized steel trough with black inside, heat exchanger and inner parts painted black, „63“ natural oak grille, transverse, roll-up „L1“ peripheral ledge „L“ with an overlap, natur anodized aluminium „L“ water connection at the left side (when installing the heat exchanger closer to the window, fans to the room) „5“ 24 V DC fans without controller (controller is not needed)



Trench heater heating output FRT 0090 0175

OPTIMIZED HEAT. OUTPUTS

Q[W] 75/65/20 °C (ΔT=50 °C)

Temperature exponent 1,055

Length L [mm]	Speed [-] / Heating output [W]					
	0 V	2 V	4 V	6 V	8 V	10 V
700	38	134	244	342	426	497
800	48	179	326	455	568	663
900	57	215	391	547	681	796
1 000	67	304	554	774	965	1 127
1 100	76	304	554	774	965	1 127
1 200	86	358	652	911	1 136	1 326
1 300	95	394	717	1 002	1 249	1 459
1 400	105	439	798	1 116	1 391	1 625
1 500	114	484	880	1 230	1 533	1 791
1 600	124	527	958	1 339	1 670	1 950
1 700	133	527	958	1 339	1 670	1 950
1 800	143	609	1 108	1 549	1 931	2 255
1 900	152	661	1 203	1 681	2 096	2 447
2 000	162	706	1 284	1 794	2 238	2 613
2 100	172	741	1 349	1 886	2 351	2 746
2 200	181	741	1 349	1 886	2 351	2 746
2 300	191	831	1 512	2 113	2 635	3 077
2 400	200	831	1 512	2 113	2 635	3 077
2 500	210	885	1 610	2 250	2 805	3 276
2 600	219	921	1 675	2 341	2 919	3 409
2 700	229	956	1 740	2 432	3 033	3 541
2 800	238	1 010	1 838	2 569	3 203	3 740
2 900	248	1 053	1 916	2 678	3 339	3 900
3 000	257	1 053	1 916	2 678	3 339	3 900
3 200	276	1 187	2 160	3 020	3 765	4 397
3 400	295	1 232	2 242	3 134	3 907	4 563
3 600	314	1 358	2 470	3 452	4 305	5 027
3 800	333	1 402	2 551	3 566	4 447	5 193
4 000	352	1 483	2 698	3 771	4 702	5 491
4 200	371	1 580	2 874	4 017	5 009	5 849
4 400	390	1 662	3 024	4 227	5 270	6 154
4 600	409	1 759	3 200	4 473	5 577	6 512
4 800	428	1 794	3 265	4 564	5 690	6 645

Q[W] 55/45/20 °C (ΔT=30 °C)

Length L [mm]	Speed [-] / Heating output [W]					
	0 V	2 V	4 V	6 V	8 V	10 V
700	18	78	142	200	249	290
800	23	104	190	265	331	387
900	28	125	228	319	397	464
1 000	32	177	323	452	563	657
1 100	37	177	323	452	563	657
1 200	42	209	380	531	663	774
1 300	46	230	418	585	729	851
1 400	51	256	466	651	811	948
1 500	55	282	513	718	894	1 045
1 600	60	307	559	781	974	1 138
1 700	64	307	559	781	974	1 138
1 800	69	355	646	904	1 127	1 316
1 900	74	386	702	981	1 223	1 428
2 000	78	412	749	1 047	1 306	1 524
2 100	83	432	787	1 100	1 372	1 602
2 200	88	432	787	1 100	1 372	1 602
2 300	92	485	882	1 233	1 537	1 795
2 400	97	485	882	1 233	1 537	1 795
2 500	102	516	939	1 313	1 636	1 911
2 600	106	537	977	1 366	1 703	1 989
2 700	111	558	1 015	1 419	1 769	2 066
2 800	115	589	1 072	1 499	1 869	2 182
2 900	120	614	1 118	1 562	1 948	2 275
3 000	124	614	1 118	1 562	1 948	2 275
3 200	134	692	1 260	1 762	2 196	2 565
3 400	143	719	1 308	1 828	2 279	2 662
3 600	152	792	1 441	2 014	2 511	2 933
3 800	161	818	1 488	2 080	2 594	3 029
4 000	170	865	1 574	2 200	2 743	3 203
4 200	180	922	1 677	2 343	2 922	3 412
4 400	189	970	1 764	2 466	3 074	3 590
4 600	198	1 026	1 867	2 609	3 253	3 799
4 800	207	1 047	1 905	2 663	3 319	3 877

75/65/20 °C → 75 °C inlet temperature, 65 °C outlet temp., 20 °C room temp. / Output 90/70/20 °C = ~ 1,22 x 75/65/20 °C / Output 70/55/20 °C = ~ 0,84 x 75/65/20 °C / Heating outputs in accordance with EN 16430 / Not listed heating outputs for lengths per 100 mm steps calculate linearly. Exact values can be found at www.isan.cz



Acoustic power [dB(A)]

Length L [mm]	Speed [-] / Acoustic power [dB(A)]					
	0 V	2 V	4 V	6 V	8 V	10 V
700	-	< 25	< 25	26	30	35
800	-	< 25	< 25	26	30	35
900	-	< 25	< 25	26	31	36
1 000	-	< 25	< 25	26	31	36
1 100	-	< 25	< 25	26	31	37
1 200	-	< 25	< 25	26	32	37
1 300	-	< 25	< 25	26	32	37
1 400	-	< 25	< 25	27	32	38
1 500	-	< 25	< 25	27	32	38
1 600	-	< 25	< 25	28	32	38
1 700	-	< 25	< 25	28	32	38
1 800	-	< 25	< 25	28	33	39
1 900	-	< 25	26	28	33	39
2 000	-	< 25	26	28	33	39
2 100	-	< 25	26	29	33	39
2 200	-	< 25	26	29	33	39
2 300	-	< 25	26	29	33	39
2 400	-	< 25	26	29	34	40
2 500	-	< 25	26	29	34	40
2 600	-	< 25	26	29	34	40
2 700	-	< 25	27	30	34	40
2 800	-	< 25	27	30	34	40
2 900	-	< 25	27	30	34	40
3 000	-	< 25	27	30	34	40
3 200	-	< 25	27	30	35	41
3 400	-	< 25	27	30	35	41
3 600	-	< 25	27	31	35	41
3 800	-	25	27	31	35	41
4 000	-	25	27	31	36	42
4 200	-	25	28	31	36	42
4 400	-	26	28	31	36	42
4 600	-	26	28	31	36	42
4 800	-	26	28	32	36	42



Fans input power [W]*

Length L [mm]	Number of fans	Speed [-] / Fans input power [W]*				
		2 V	4 V	6 V	8 V	10 V
700	1	1	1	2	2	3
800	1	1	1	2	3	4
900	1	1	2	2	3	5
1 000	1	1	2	3	4	6
1 100	1	1	2	3	4	6
1 200	2	2	2	4	5	8
1 300	2	2	3	4	6	9
1 400	2	2	3	4	6	9
1 500	2	2	3	4	7	10
1 600	1	1	2	3	6	10
1 700	2	2	3	4	7	11
1 800	2	2	3	5	8	12
1 900	2	2	3	4	7	12
2 000	2	2	3	5	8	13
2 100	2	2	3	5	8	14
2 200	2	2	3	5	8	14
2 300	2	2	3	5	9	16
2 400	2	2	3	5	9	16
2 500	3	3	4	6	10	17
2 600	3	3	4	6	11	18
2 700	3	3	4	6	11	19
2 800	3	3	4	7	12	19
2 900	2	2	3	5	11	19
3 000	3	3	4	7	12	20
3 200	3	3	4	6	12	22
3 400	3	3	4	7	13	23
3 600	3	3	5	7	14	25
3 800	4	4	6	8	15	26
4 000	4	4	6	9	16	28
4 200	3	3	5	8	16	28
4 400	4	4	6	10	18	31
4 600	4	4	6	9	18	32
4 800	4	4	6	9	18	33

* Approximate fan input powers / When using electrothermal actuator add in the trench heater's power 3 W

FRT 0090 0200

TRENCH HEATER WITH FAN



- › Flats, detached houses, offices, administrative buildings
- › Small universal trench heater
- › High heating output
- › Continuous speed control
- › Quiet operation
- › Common electricity consumption **3 W/m**
- › Using in dry environment



Technical data

Trench heater

Height [H]	90 mm
Width [W]	200 mm
Length [L]	700-4800 mm in step 100 mm

Heat exchanger

Type	Al-Cu lamellar
Length	L-295 mm
Connection thread	2xG1/2" inner

Working conditions

Max. temperature	110 °C
Max. overpressure	1 MPa (10 bar)
Protection	IP 20
Ambient conditions	Temp. T = +2 to +40 °C Humidity Rh = 20 to 70%

Trench heater standard equipment

Trough	Galvanized steel trough with surface finish and black spray layer inside, black cover plates of connection
Heat exchanger	Al-Cu lamellar exchanger with air vent valve, black painted
Grille	Design walkable grille according the customer's choice (stainless grilles surcharge)
Ledge	Made of anodized aluminium, type and colour according the customer's choice
Fan	Modern tangential fan with 24 V DC EC motor with high efficiency, rotors protection
Assembly elements	Leveling screws for setting up the trough, mounting brackets
Manual	Manual for the progress of work during installation and user manual
Wiring	Electrical wiring diagram of the trench heaters
Mounting board	Cover and the spacer particle board for easy installation
Package	Transport package for protection against damage during transportation and handling

Technical drawing

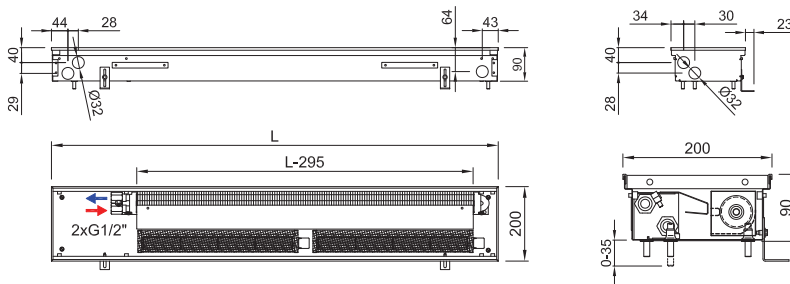

Connection to heating system

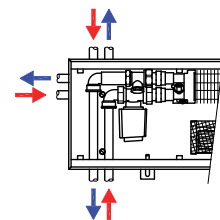

Accessories per order



Variants

Grilles

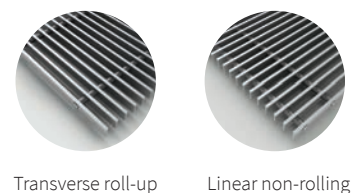

Peripheral ledge

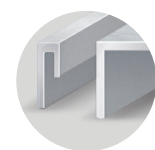

① Grilles → 6 ② Ledges → 8 ③ Acoustic power → 13 ④ Accessories → 14 ⑤ Hydraulic parameters → 126 ⑥ Wiring → 129

Code example: FRT 0090 0200 1900 C 52 J1 R - 5

Trench heater **FRT** H=90 mm, W= 200 mm, L=1 900 mm, „C“ Galvanized steel trough with black inside, heat exchanger and inner parts painted black, „52“ stainless grille, transverse, roll-up, „J1“ peripheral ledge „J“, natur anodized aluminium, „R“ water connection at the right side (when installing the heat exchanger closer to the window, fans to the room), „5“ 24 V DC fans without controller (controller is not needed)



Trench heater heating output FRT 0090 0200

OPTIMIZED HEAT. OUTPUTS

Q[W] 75/65/20 °C (ΔT=50 °C)

Temperature exponent 1,054

Length L [mm]	Speed [-] / Heating output [W]					
	0 V	2 V	4 V	6 V	8 V	10 V
700	39	137	256	361	452	528
800	49	183	342	482	603	705
900	59	220	410	578	723	845
1 000	69	311	581	819	1 025	1 198
1 100	78	311	581	819	1 025	1 198
1 200	88	366	684	964	1 205	1 409
1 300	98	403	752	1 060	1 326	1 550
1 400	108	449	838	1 180	1 477	1 726
1 500	117	495	923	1 301	1 627	1 902
1 600	127	539	1 006	1 417	1 772	2 071
1 700	137	539	1 006	1 417	1 772	2 071
1 800	147	623	1 163	1 638	2 049	2 395
1 900	156	676	1 262	1 778	2 224	2 600
2 000	166	722	1 347	1 898	2 374	2 776
2 100	176	758	1 416	1 995	2 495	2 917
2 200	185	758	1 416	1 995	2 495	2 917
2 300	195	850	1 587	2 236	2 796	3 269
2 400	205	850	1 587	2 236	2 796	3 269
2 500	215	905	1 689	2 380	2 977	3 480
2 600	224	942	1 758	2 477	3 098	3 621
2 700	234	978	1 826	2 573	3 218	3 762
2 800	244	1 033	1 929	2 717	3 399	3 974
2 900	254	1 077	2 011	2 833	3 544	4 143
3 000	263	1 077	2 011	2 833	3 544	4 143
3 200	283	1 214	2 267	3 194	3 996	4 671
3 400	302	1 260	2 353	3 315	4 146	4 847
3 600	322	1 389	2 592	3 652	4 568	5 340
3 800	341	1 434	2 678	3 773	4 719	5 517
4 000	361	1 517	2 832	3 989	4 990	5 834
4 200	380	1 616	3 017	4 250	5 316	6 214
4 400	400	1 700	3 174	4 471	5 593	6 538
4 600	419	1 799	3 358	4 731	5 918	6 919
4 800	439	1 835	3 427	4 828	6 039	7 060

Q[W] 55/45/20 °C (ΔT=30 °C)

Length L [mm]	Speed [-] / Heating output [W]					
	0 V	2 V	4 V	6 V	8 V	10 V
700	19	80	149	211	264	308
800	24	107	200	281	352	411
900	29	128	239	337	422	493
1 000	33	182	339	478	598	699
1 100	38	182	339	478	598	699
1 200	43	214	399	563	703	822
1 300	47	235	439	619	774	905
1 400	52	262	489	689	862	1 007
1 500	57	289	539	759	950	1 110
1 600	61	315	587	827	1 034	1 209
1 700	66	315	587	827	1 034	1 209
1 800	71	364	679	956	1 196	1 398
1 900	76	395	737	1 038	1 298	1 518
2 000	80	421	786	1 108	1 386	1 620
2 100	85	442	826	1 164	1 456	1 703
2 200	90	442	826	1 164	1 456	1 703
2 300	94	496	926	1 305	1 632	1 908
2 400	99	496	926	1 305	1 632	1 908
2 500	104	528	986	1 389	1 738	2 031
2 600	108	550	1 026	1 446	1 808	2 113
2 700	113	571	1 066	1 502	1 878	2 196
2 800	118	603	1 126	1 586	1 984	2 320
2 900	123	629	1 174	1 654	2 069	2 418
3 000	127	629	1 174	1 654	2 069	2 418
3 200	137	709	1 323	1 864	2 332	2 726
3 400	146	735	1 373	1 935	2 420	2 829
3 600	156	811	1 513	2 132	2 666	3 117
3 800	165	837	1 563	2 202	2 754	3 220
4 000	175	885	1 653	2 328	2 913	3 405
4 200	184	943	1 761	2 481	3 103	3 627
4 400	194	992	1 853	2 610	3 264	3 816
4 600	203	1 050	1 960	2 761	3 454	4 038
4 800	213	1 071	2 000	2 818	3 525	4 121

75/65/20 °C → 75 °C inlet temperature, 65 °C outlet temp., 20 °C room temp. / Output 90/70/20 °C = ~ 1,22 x 75/65/20 °C / Output 70/55/20 °C = ~ 0,84 x 75/65/20 °C / Heating outputs in accordance with EN 16430 / Not listed heating outputs for lengths per 100 mm steps calculate linearly. Exact values can be found at www.isan.cz

Acoustic power [dB(A)]

Length L [mm]	Speed [-] / Acoustic power [dB(A)]					
	0 V	2 V	4 V	6 V	8 V	10 V
700	-	< 25	26	30	35	42
800	-	< 25	26	30	36	43
900	-	< 25	27	31	36	44
1 000	-	< 25	27	31	38	45
1 100	-	< 25	27	32	39	45
1 200	-	< 25	28	32	39	46
1 300	-	< 25	28	33	40	46
1 400	-	< 25	28	33	40	47
1 500	-	< 25	29	34	41	47
1 600	-	< 25	29	34	41	48
1 700	-	< 25	29	35	41	48
1 800	-	< 25	29	35	42	48
1 900	-	< 25	30	35	42	49
2 000	-	< 25	30	36	42	49
2 100	-	< 25	30	36	43	49
2 200	-	< 25	30	36	43	50
2 300	-	< 25	30	37	43	50
2 400	-	< 25	31	37	44	50
2 500	-	< 25	31	37	44	51
2 600	-	< 25	31	38	44	51
2 700	-	< 25	31	38	44	51
2 800	-	< 25	31	38	45	51
2 900	-	< 25	31	38	45	52
3 000	-	< 25	32	38	45	52
3 200	-	< 25	32	39	46	52
3 400	-	< 25	32	39	46	53
3 600	-	< 25	32	39	46	53
3 800	-	< 25	33	40	47	53
4 000	-	< 25	33	40	47	54
4 200	-	< 25	33	41	47	54
4 400	-	< 25	33	41	48	54
4 600	-	< 25	33	41	48	55
4 800	-	25	34	42	49	55

Fans input power [W]*

Length L [mm]	Number of fans	Speed [-] / Fans input power [W]*				
		2 V	4 V	6 V	8 V	10 V
700	1	1	1	2	2	3
800	1	1	1	2	3	4
900	1	1	2	2	3	5
1 000	1	1	2	3	4	6
1 100	1	1	2	3	4	6
1 200	2	2	2	4	5	8
1 300	2	2	3	4	6	9
1 400	2	2	3	4	6	9
1 500	2	2	3	4	7	10
1 600	1	1	2	3	6	10
1 700	2	2	3	4	7	11
1 800	2	2	3	5	8	12
1 900	2	2	3	4	7	12
2 000	2	2	3	5	8	13
2 100	2	2	3	5	8	14
2 200	2	2	3	5	8	14
2 300	2	2	3	5	9	16
2 400	2	2	3	5	9	16
2 500	3	3	4	6	10	17
2 600	3	3	4	6	11	18
2 700	3	3	4	6	11	19
2 800	3	3	4	7	12	19
2 900	2	2	3	5	11	19
3 000	3	3	4	7	12	20
3 200	3	3	4	6	12	22
3 400	3	3	4	7	13	23
3 600	3	3	5	7	14	25
3 800	4	4	6	8	15	26
4 000	4	4	6	9	16	28
4 200	3	3	5	8	16	28
4 400	4	4	6	10	18	31
4 600	4	4	6	9	18	32
4 800	4	4	6	9	18	33

* Approximate fan input powers / When using electrothermal actuator add in the trench heater's power 3 W

FRT 0090 0250

TRENCH HEATER WITH FAN

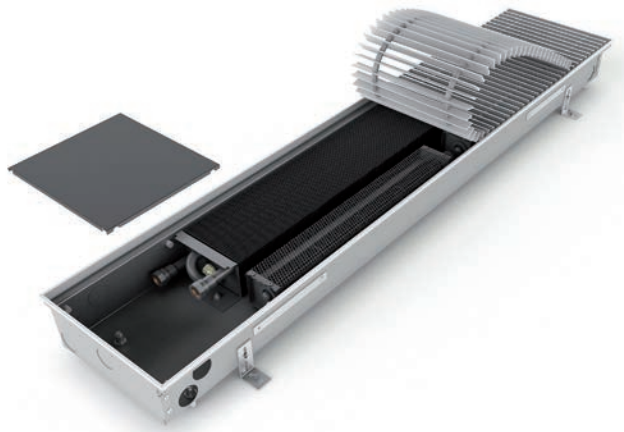

- › Flats, detached houses, offices, administrative buildings
- › Small universal trench heater
- › High heating output
- › Continuous speed control
- › Quiet operation
- › Common electricity consumption **3 W/m**
- › Using in dry environment

Technical data

Trench heater

Height [H]	90 mm
Width [W]	250 mm
Length [L]	700-4800 mm in step 100 mm

Heat exchanger

Type	Al-Cu lamellar
Length	L-295 mm
Connection thread	2×G1/2" inner

Working conditions

Max. temperature	110 °C
Max. overpressure	1 MPa (10 bar)
Protection	IP 20
Ambient conditions	Temp. T = +2 to +40 °C Humidity Rh = 20 to 70%

Trench heater standard equipment

Trough	Galvanized steel trough with surface finish and black spray layer inside, black cover plates of connection
Heat exchanger	Al-Cu lamellar exchanger with air vent valve, black painted
Grille	Design walkable grille according the customer's choice (stainless grilles surcharge)
Ledge	Made of anodized aluminium, type and colour according the customer's choice
Fan	Modern tangential fan with 24 V DC EC motor with high efficiency, rotors protection
Assembly elements	Leveling screws for setting up the trough, mounting brackets
Manual	Manual for the progress of work during installation and user manual
Wiring	Electrical wiring diagram of the trench heaters
Mounting board	Cover and the spacer particle board for easy installation
Package	Transport package for protection against damage during transportation and handling

Technical drawing

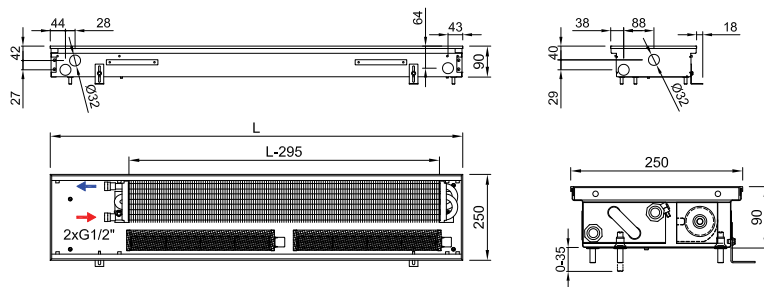

Connection to heating system

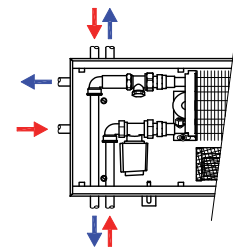

Accessories per order



Variants

Grilles

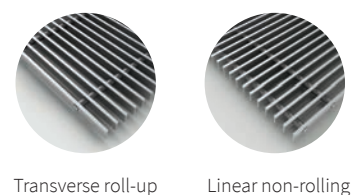

Peripheral ledge

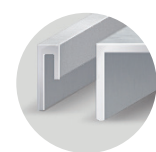

- ① Grilles → 6
 ② Ledges → 8
 ③ Acoustic power → 13
 ④ Accessories → 14
 ⑤ Hydraulic parameters → 126
 ⑥ Wiring → 129

Code example: FRT 0090 0250 1500 C 62 L2 L - 5

Trench heater FRT H=90 mm, W= 250 mm, L=1 500 mm, „C“ Galvanized steel trough with black inside, heat exchanger and inner parts painted black, „62“ stained beech grille, transverse, roll-up „L2“ peripheral ledge „L“ with an overlap, bronze anodized aluminium, „L“ water connection at the left side (when installing the heat exchanger closer to the window, fans to the room) „5“ 24 V DC fans without controller (controller is not needed)



Trench heater heating output FRT 0090 0250

Q[W] 75/65/20 °C (ΔT=50 °C)

Temperature exponent 1,1

Length L [mm]	Speed [-] / Heating output [W]					
	0 V	2 V	4 V	6 V	8 V	10 V
700	79	253	402	535	652	752
800	98	337	536	714	869	1 003
900	118	404	644	856	1 043	1 204
1 000	137	573	912	1 213	1 478	1 705
1 100	157	573	912	1 213	1 478	1 705
1 200	176	674	1 073	1 427	1 739	2 006
1 300	196	741	1 180	1 570	1 913	2 207
1 400	215	826	1 314	1 749	2 130	2 458
1 500	235	910	1 448	1 927	2 347	2 709
1 600	254	991	1 577	2 098	2 556	2 949
1 700	274	991	1 577	2 098	2 556	2 949
1 800	293	1 146	1 823	2 427	2 956	3 411
1 900	313	1 244	1 979	2 634	3 208	3 702
2 000	332	1 328	2 113	2 812	3 425	3 953
2 100	351	1 395	2 220	2 955	3 599	4 153
2 200	371	1 395	2 220	2 955	3 599	4 153
2 300	390	1 564	2 488	3 312	4 034	4 655
2 400	410	1 564	2 488	3 312	4 034	4 655
2 500	429	1 665	2 649	3 526	4 295	4 956
2 600	449	1 732	2 756	3 668	4 468	5 156
2 700	468	1 800	2 864	3 811	4 642	5 357
2 800	488	1 901	3 025	4 025	4 903	5 658
2 900	507	1 982	3 153	4 197	5 112	5 899
3 000	527	1 982	3 153	4 197	5 112	5 899
3 200	566	2 234	3 555	4 732	5 764	6 651
3 400	605	2 319	3 689	4 910	5 981	6 902
3 600	644	2 555	4 065	5 410	6 590	7 604
3 800	682	2 639	4 199	5 588	6 807	7 855
4 000	721	2 791	4 440	5 909	7 198	8 307
4 200	760	2 973	4 730	6 295	7 668	8 848
4 400	799	3 128	4 977	6 623	8 068	9 310
4 600	838	3 310	5 266	7 009	8 537	9 851
4 800	877	3 377	5 373	7 151	8 711	10 052

75/65/20 °C → 75 °C inlet temperature, 65 °C outlet temp., 20 °C room temp. / Output 90/70/20 °C = ~ 1,22 x 75/65/20 °C / Output 70/55/20 °C = ~ 0,84 x 75/65/20 °C. / Heating outputs in accordance with EN 16430 / Not listed heating outputs for lengths per 100 mm steps calculate linearly. Exact values can be found at www.isan.cz

Q[W] 55/45/20 °C (ΔT=30 °C)

Length L [mm]	Speed [-] / Heating output [W]					
	0 V	2 V	4 V	6 V	8 V	10 V
700	38	144	229	305	372	429
800	47	192	306	407	495	572
900	57	230	367	488	595	686
1 000	66	327	520	692	843	972
1 100	76	327	520	692	843	972
1 200	85	384	612	814	991	1 144
1 300	95	422	673	895	1 091	1 258
1 400	104	471	749	997	1 214	1 401
1 500	114	519	826	1 099	1 338	1 544
1 600	123	565	899	1 196	1 457	1 681
1 700	133	565	899	1 196	1 457	1 681
1 800	142	653	1 039	1 384	1 685	1 945
1 900	152	709	1 128	1 502	1 829	2 111
2 000	161	757	1 205	1 603	1 953	2 254
2 100	170	795	1 266	1 685	2 052	2 368
2 200	180	795	1 266	1 685	2 052	2 368
2 300	189	892	1 418	1 888	2 300	2 654
2 400	198	892	1 418	1 888	2 300	2 654
2 500	208	949	1 510	2 010	2 449	2 826
2 600	217	987	1 571	2 091	2 547	2 940
2 700	227	1 026	1 633	2 173	2 646	3 054
2 800	236	1 084	1 725	2 295	2 795	3 226
2 900	245	1 130	1 798	2 393	2 914	3 363
3 000	255	1 130	1 798	2 393	2 914	3 363
3 200	274	1 274	2 027	2 698	3 286	3 792
3 400	293	1 322	2 103	2 799	3 410	3 935
3 600	312	1 457	2 318	3 084	3 757	4 335
3 800	330	1 505	2 394	3 186	3 881	4 478
4 000	349	1 591	2 531	3 369	4 104	4 736
4 200	368	1 695	2 697	3 589	4 372	5 044
4 400	387	1 783	2 837	3 776	4 600	5 308
4 600	406	1 887	3 002	3 996	4 867	5 616
4 800	425	1 925	3 063	4 077	4 966	5 731

Acoustic power [dB(A)]

Length L [mm]	Speed [-] / Acoustic power [dB(A)]					
	0 V	2 V	4 V	6 V	8 V	10 V
700	-	< 25	25	30	35	42
800	-	< 25	26	30	36	43
900	-	< 25	26	31	37	44
1 000	-	< 25	27	32	38	45
1 100	-	< 25	27	32	38	45
1 200	-	< 25	27	33	39	46
1 300	-	< 25	28	33	40	46
1 400	-	< 25	28	33	40	47
1 500	-	< 25	29	34	41	47
1 600	-	< 25	29	34	41	48
1 700	-	< 25	29	35	41	48
1 800	-	< 25	29	35	41	48
1 900	-	< 25	30	35	42	49
2 000	-	< 25	30	36	42	49
2 100	-	< 25	30	36	43	49
2 200	-	< 25	30	36	43	50
2 300	-	< 25	30	37	43	50
2 400	-	< 25	31	37	44	50
2 500	-	< 25	31	37	44	51
2 600	-	< 25	31	38	44	51
2 700	-	< 25	31	38	44	51
2 800	-	< 25	31	38	45	51
2 900	-	< 25	31	38	45	52
3 000	-	< 25	32	38	45	52
3 200	-	< 25	32	39	46	52
3 400	-	< 25	32	39	46	53
3 600	-	< 25	32	39	46	53
3 800	-	< 25	33	40	47	53
4 000	-	< 25	33	40	47	54
4 200	-	< 25	33	41	47	54
4 400	-	< 25	33	41	48	54
4 600	-	< 25	33	41	48	55
4 800	-	25	34	42	49	55

Fans input power [W]*

Length L [mm]	Number of fans	Speed [-] / Fans input power [W]*				
		2 V	4 V	6 V	8 V	10 V
700	1	1	1	2	2	3
800	1	1	1	2	3	4
900	1	1	2	2	3	5
1 000	1	1	2	3	4	6
1 100	1	1	2	3	4	6
1 200	2	2	2	4	5	8
1 300	2	2	3	4	6	9
1 400	2	2	3	4	6	9
1 500	2	2	3	4	7	10
1 600	1	1	2	3	6	10
1 700	2	2	3	4	7	11
1 800	2	2	3	5	8	12
1 900	2	2	3	4	7	12
2 000	2	2	3	5	8	13
2 100	2	2	3	5	8	14
2 200	2	2	3	5	8	14
2 300	2	2	3	5	9	16
2 400	2	2	3	5	9	16
2 500	3	3	4	6	10	17
2 600	3	3	4	6	11	18
2 700	3	3	4	6	11	19
2 800	3	3	4	7	12	19
2 900	2	2	3	5	11	19
3 000	3	3	4	7	12	20
3 200	3	3	4	6	12	22
3 400	3	3	4	7	13	23
3 600	3	3	5	7	14	25
3 800	4	4	6	8	15	26
4 000	4	4	6	9	16	28
4 200	3	3	5	8	16	28
4 400	4	4	6	10	18	31
4 600	4	4	6	9	18	32
4 800	4	4	6	9	18	33

* Approximate fan input powers / When using electrothermal actuator add in the trench heater's power 3 W

FRT 0090 0300

TRENCH HEATER WITH FAN



- > Flats, detached houses, offices, administrative buildings
- > Low trench heater with a good heating output
- > High heating output
- > Continuous speed control
- > Quiet operation
- > Common electricity consumption **3 W/m**
- > Using in dry environment

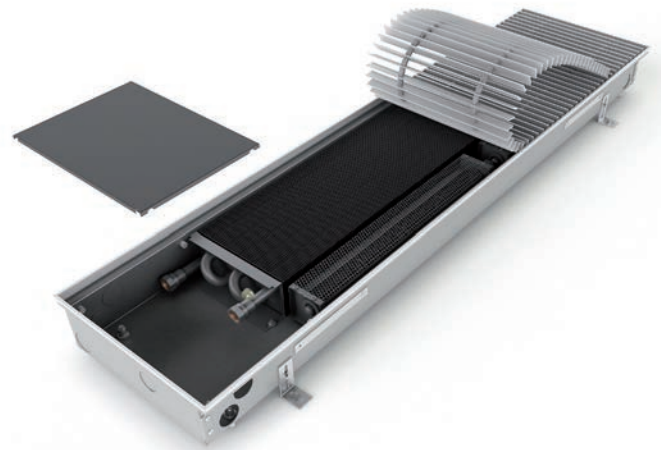

Technical data

Trench heater

Height [H]	90 mm
Width [W]	300 mm
Length [L]	700-4800 mm in step 100 mm

Heat exchanger

Type	Al-Cu lamellar
Length	L-295 mm
Connection thread	2xG1/2" inner

Working conditions

Max. temperature	110 °C
Max. overpressure	1 MPa (10 bar)
Protection	IP 20
Ambient conditions	Temp. T = +2 to +40 °C Humidity Rh = 20 to 70%

Trench heater standard equipment

Trough	Galvanized steel trough with surface finish and black spray layer inside, black cover plates of connection
Heat exchanger	Al-Cu lamellar exchanger with air vent valve, black painted
Grille	Design walkable grille according the customer's choice (stainless grilles surcharge)
Ledge	Made of anodized aluminium, type and colour according the customer's choice
Fan	Modern tangential fan with 24 V DC EC motor with high efficiency, rotors protection
Assembly elements	Leveling screws for setting up the trough, mounting brackets
Manual	Manual for the progress of work during installation and user manual
Wiring	Electrical wiring diagram of the trench heaters
Mounting board	Cover and the spacer particle board for easy installation
Package	Transport package for protection against damage during transportation and handling

Technical drawing

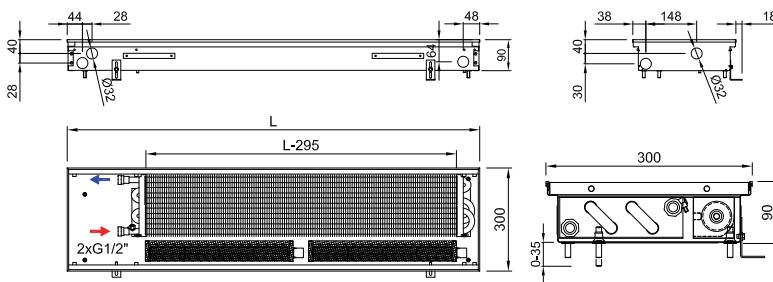

Connection to heating system

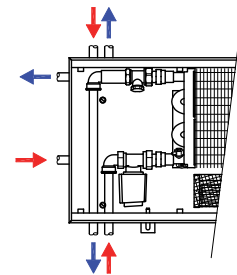

Accessories per order



Variants

Grilles

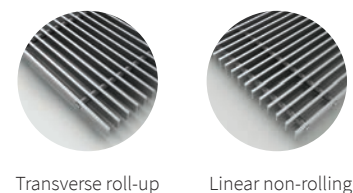

Peripheral ledge

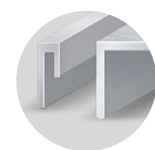

- ⓘ Grilles → 6
 Ⓜ Ledges → 8
 Ⓜ Acoustic power → 13
 ⊕ Accessories → 14
 Ⓜ Hydraulic parameters → 126
 Ⓜ Wiring → 129

Code example: FRT 0090 0300 2700 C 32 J3 R - 5

Trench heater FRT H=90 mm, W= 300 mm, L=2 700 mm, „C“ Galvanized steel trough with black inside, heat exchanger and inner parts painted black, „32“ black anodized aluminium grille, linear, rigid, „J3“ peripheral ledge „J“, black anodized aluminium „R“ water connection at the right side (when installing the heat exchanger closer to the window, fans to the room), „5“ 24 V DC fans without controller (controller is not needed)



Trench heater heating output FRT 0090 0300

Q[W] 75/65/20 °C (ΔT=50 °C)

Temperature exponent 1,1

Length L [mm]	Speed [-] / Heating output [W]					
	0 V	2 V	4 V	6 V	8 V	10 V
700	85	271	430	571	695	802
800	105	361	573	761	927	1 069
900	126	433	687	914	1 112	1 283
1 000	147	613	974	1 294	1 576	1 818
1 100	168	613	974	1 294	1 576	1 818
1 200	189	722	1 145	1 523	1 854	2 138
1 300	210	794	1 260	1 675	2 039	2 352
1 400	231	884	1 403	1 865	2 271	2 620
1 500	252	974	1 546	2 056	2 503	2 887
1 600	272	1 061	1 684	2 239	2 725	3 143
1 700	293	1 061	1 684	2 239	2 725	3 143
1 800	314	1 227	1 947	2 589	3 152	3 635
1 900	335	1 331	2 113	2 810	3 420	3 945
2 000	356	1 422	2 256	3 000	3 652	4 213
2 100	377	1 494	2 371	3 152	3 837	4 426
2 200	398	1 494	2 371	3 152	3 837	4 426
2 300	419	1 674	2 657	3 533	4 301	4 961
2 400	440	1 674	2 657	3 533	4 301	4 961
2 500	460	1 782	2 829	3 761	4 579	5 282
2 600	481	1 854	2 944	3 914	4 764	5 496
2 700	502	1 927	3 058	4 066	4 950	5 709
2 800	523	2 035	3 230	4 294	5 228	6 030
2 900	544	2 121	3 368	4 477	5 450	6 287
3 000	565	2 121	3 368	4 477	5 450	6 287
3 200	607	2 392	3 797	5 048	6 145	7 089
3 400	648	2 482	3 940	5 239	6 377	7 356
3 600	690	2 735	4 341	5 772	7 026	8 104
3 800	732	2 825	4 484	5 962	7 258	8 372
4 000	774	2 987	4 742	6 305	7 675	8 853
4 200	815	3 182	5 051	6 716	8 175	9 430
4 400	857	3 348	5 315	7 066	8 602	9 922
4 600	899	3 543	5 624	7 477	9 102	10 499
4 800	941	3 615	5 739	7 629	9 288	10 713

75/65/20 °C → 75 °C inlet temperature, 65 °C outlet temp., 20 °C room temp. / Output 90/70/20 °C = ~ 1,22 x 75/65/20 °C / Output 70/55/20 °C = ~ 0,84 x 75/65/20 °C / Heating outputs in accordance with EN 16430 / Not listed heating outputs for lengths per 100 mm steps calculate linearly. Exact values can be found at www.isan.cz

Acoustic power [dB(A)]

Length L [mm]	Speed [-] / Acoustic power [dB(A)]					
	0 V	2 V	4 V	6 V	8 V	10 V
700	-	< 25	25	30	35	42
800	-	< 25	26	30	36	43
900	-	< 25	26	31	37	44
1 000	-	< 25	27	32	38	45
1 100	-	< 25	27	32	38	45
1 200	-	< 25	27	33	39	46
1 300	-	< 25	28	33	40	46
1 400	-	< 25	28	33	40	47
1 500	-	< 25	29	34	41	47
1 600	-	< 25	29	34	41	48
1 700	-	< 25	29	35	41	48
1 800	-	< 25	29	35	41	48
1 900	-	< 25	30	35	42	49
2 000	-	< 25	30	36	42	49
2 100	-	< 25	30	36	43	49
2 200	-	< 25	30	36	43	50
2 300	-	< 25	30	37	43	50
2 400	-	< 25	31	37	44	50
2 500	-	< 25	31	37	44	51
2 600	-	< 25	31	38	44	51
2 700	-	< 25	31	38	44	51
2 800	-	< 25	31	38	45	51
2 900	-	< 25	31	38	45	52
3 000	-	< 25	32	38	45	52
3 200	-	< 25	32	39	46	52
3 400	-	< 25	32	39	46	53
3 600	-	< 25	32	39	46	53
3 800	-	< 25	33	40	47	53
4 000	-	< 25	33	40	47	54
4 200	-	< 25	33	41	47	54
4 400	-	< 25	33	41	48	54
4 600	-	< 25	33	41	48	55
4 800	-	25	34	42	49	55

Q[W] 55/45/20 °C (ΔT=30 °C)

Length L [mm]	Speed [-] / Heating output [W]					
	0 V	2 V	4 V	6 V	8 V	10 V
700	41	155	245	326	396	457
800	51	206	327	434	529	609
900	61	247	392	521	634	731
1 000	71	349	555	738	899	1 036
1 100	81	349	555	738	899	1 036
1 200	92	412	653	868	1 057	1 219
1 300	102	453	718	955	1 162	1 341
1 400	112	504	800	1 063	1 295	1 494
1 500	122	555	881	1 172	1 427	1 646
1 600	132	605	960	1 276	1 554	1 792
1 700	142	605	960	1 276	1 554	1 792
1 800	152	700	1 110	1 476	1 797	2 072
1 900	162	759	1 205	1 602	1 950	2 249
2 000	172	811	1 286	1 710	2 082	2 402
2 100	183	852	1 352	1 797	2 188	2 523
2 200	193	852	1 352	1 797	2 188	2 523
2 300	203	954	1 515	2 014	2 452	2 828
2 400	213	954	1 515	2 014	2 452	2 828
2 500	223	1 016	1 613	2 144	2 611	3 011
2 600	233	1 057	1 678	2 231	2 716	3 133
2 700	243	1 099	1 743	2 318	2 822	3 255
2 800	253	1 160	1 841	2 448	2 981	3 438
2 900	263	1 209	1 920	2 552	3 107	3 584
3 000	274	1 209	1 920	2 552	3 107	3 584
3 200	294	1 364	2 165	2 878	3 503	4 042
3 400	314	1 415	2 246	2 987	3 636	4 194
3 600	334	1 559	2 475	3 291	4 006	4 620
3 800	354	1 611	2 556	3 399	4 138	4 773
4 000	375	1 703	2 704	3 595	4 376	5 047
4 200	395	1 814	2 880	3 829	4 661	5 376
4 400	415	1 909	3 030	4 028	4 904	5 657
4 600	435	2 020	3 206	4 263	5 189	5 986
4 800	456	2 061	3 272	4 349	5 295	6 108

Fans input power [W]*

Length L [mm]	Number of fans	Speed [-] / Fans input power [W]*				
		2 V	4 V	6 V	8 V	10 V
700	1	1	1	2	2	3
800	1	1	1	2	3	4
900	1	1	2	2	3	5
1 000	1	1	2	3	4	6
1 100	1	1	2	3	4	6
1 200	2	2	2	4	5	8
1 300	2	2	3	4	6	9
1 400	2	2	3	4	6	9
1 500	2	2	3	4	7	10
1 600	1	1	2	3	6	10
1 700	2	2	3	4	7	11
1 800	2	2	3	5	8	12
1 900	2	2	3	4	7	12
2 000	2	2	3	5	8	13
2 100	2	2	3	5	8	14
2 200	2	2	3	5	8	14
2 300	2	2	3	5	9	16
2 400	2	2	3	5	9	16
2 500	3	3	4	6	10	17
2 600	3	3	4	6	11	18
2 700	3	3	4	6	11	19
2 800	3	3	4	7	12	19
2 900	2	2	3	5	11	19
3 000	3	3	4	7	12	20
3 200	3	3	4	6	12	22
3 400	3	3	4	7	13	23
3 600	3	3	5	7	14	25
3 800	4	4	6	8	15	26
4 000	4	4	6	9	16	28
4 200	3	3	5	8	16	28
4 400	4	4	6	10	18	31
4 600	4	4	6	9	18	32
4 800	4	4	6	9	18	33

* Approximate fan input powers / When using electrothermal actuator add in the trench heater's power 3 W

FRT 0090 0425

TRENCH HEATER WITH FAN



- › Flats, detached houses, offices, administrative buildings
- › High heating output
- › Continuous speed control
- › Quiet operation
- › Common electricity consumption **3 W/m**
- › Using in dry environment

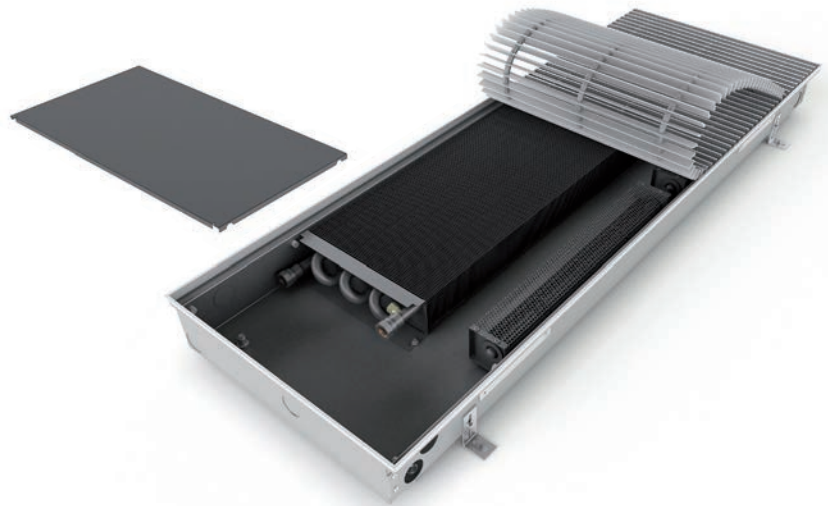

Technical data

Trench heater

Height [H]	90 mm
Width [W]	425 mm
Length [L]	700-4 800 mm in step 100 mm

Heat exchanger

Typ	Al-Cu lamellar
Length	L-295 mm
Connection thread	2×G1/2" inner

Working conditions

Max. temperature	110 °C
Max. overpressure	1 MPa (10 bar)
Protection	IP 20
Ambient conditions	Temp. T = +2 to +40 °C Humidity Rh = 20 to 70%

Trench heater standard equipment

Trough	Galvanized steel trough with surface finish and black spray layer inside, black cover plates of connection
Heat exchanger	Al-Cu lamellar exchanger with air vent valve, black painted
Grille	Design walkable grille according the customer's choice (stainless grilles surcharge)
Ledge	Made of anodized aluminium, type and colour according the customer's choice
Fan	Modern tangential fan with 24 V DC EC motor with high efficiency, rotors protection
Assembly elements	Leveling screws for setting up the trough, mounting brackets
Manual	Manual for the progress of work during installation and user manual
Wiring	Electrical wiring diagram of the trench heaters
Mounting board	Cover and the spacer particle board for easy installation
Package	Transport package for protection against damage during transportation and handling

Technical drawing

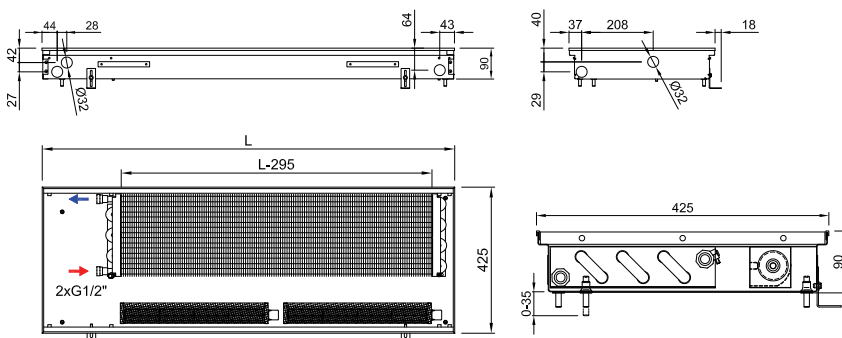

Connection to heating system

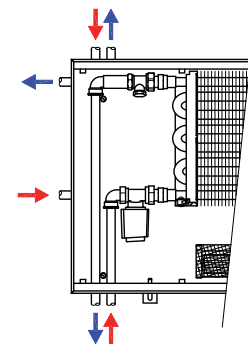

Accessories per order



Variants

Grilles

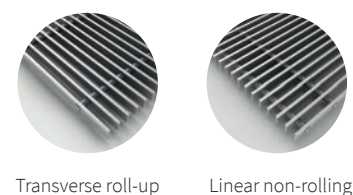

Peripheral ledge

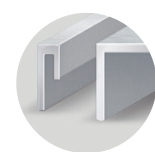

- ① Grilles → 6
 ② Ledges → 8
 ③ Acoustic power → 13
 ④ Accessories → 14
 ⑤ Hydraulic parameters → 126
 ⑥ Wiring → 129

Code example: FRT 0090 0425 4400 C 64 L2 L - 5

Trench heater FRT H=90 mm, W= 425 mm, L=4 400 mm, „C“ Galvanized steel trough with black inside, heat exchanger and inner parts painted black, „64“ stained oak grille, transverse, roll-up, „L2“ peripheral ledge „L“ with an overlap, bronze anodized aluminium, „L“ water connection at the left side (when installing the heat exchanger closer to the window, fans to the room), „5“ 24 V DC fans without controller (controller is not needed)



Trench heater heating output FRT 0090 0425

Q[W] 75/65/20 °C (ΔT=50 °C)

Temperature exponent 1,1

Length L [mm]	Speed [-] / Heating output [W]					
	0 V	2 V	4 V	6 V	8 V	10 V
700	90	288	472	632	768	880
800	112	384	629	842	1 024	1 173
900	134	461	755	1 011	1 228	1 407
1 000	157	653	1 070	1 432	1 740	1 994
1 100	179	653	1 070	1 432	1 740	1 994
1 200	201	768	1 259	1 685	2 047	2 346
1 300	223	845	1 384	1 853	2 252	2 580
1 400	246	941	1 542	2 064	2 508	2 873
1 500	268	1 037	1 699	2 275	2 764	3 167
1 600	290	1 130	1 850	2 477	3 009	3 448
1 700	312	1 130	1 850	2 477	3 009	3 448
1 800	335	1 306	2 140	2 864	3 480	3 988
1 900	357	1 418	2 322	3 109	3 777	4 328
2 000	379	1 514	2 479	3 319	4 033	4 621
2 100	401	1 591	2 605	3 488	4 238	4 855
2 200	423	1 591	2 605	3 488	4 238	4 855
2 300	446	1 783	2 920	3 909	4 749	5 442
2 400	468	1 783	2 920	3 909	4 749	5 442
2 500	490	1 898	3 109	4 162	5 057	5 794
2 600	512	1 975	3 235	4 330	5 261	6 028
2 700	535	2 052	3 361	4 499	5 466	6 263
2 800	557	2 167	3 549	4 751	5 773	6 615
2 900	579	2 259	3 700	4 953	6 019	6 896
3 000	601	2 259	3 700	4 953	6 019	6 896
3 200	646	2 548	4 172	5 585	6 786	7 776
3 400	690	2 644	4 330	5 796	7 042	8 069
3 600	735	2 913	4 770	6 386	7 759	8 890
3 800	779	3 009	4 927	6 596	8 015	9 183
4 000	824	3 182	5 211	6 975	8 475	9 711
4 200	868	3 389	5 551	7 430	9 028	10 344
4 400	912	3 566	5 840	7 818	9 499	10 884
4 600	957	3 773	6 180	8 273	10 052	11 517
4 800	1 001	3 850	6 306	8 441	10 256	11 752

75/65/20 °C → 75 °C inlet temperature, 65 °C outlet temp., 20 °C room temp. / Output 90/70/20 °C = ~ 1,22 x 75/65/20 °C / Output 70/55/20 °C = ~ 0,84 x 75/65/20 °C / Heating outputs in accordance with EN 16430 / Not listed heating outputs for lengths per 100 mm steps calculate linearly. Exact values can be found at www.isan.cz

Acoustic power [dB(A)]

Length L [mm]	Speed [-] / Acoustic power [dB(A)]					
	0 V	2 V	4 V	6 V	8 V	10 V
700	-	< 25	25	29	34	42
800	-	< 25	26	30	36	43
900	-	25	27	31	36	44
1 000	-	26	27	31	36	44
1 100	-	26	28	32	38	45
1 200	-	26	28	32	38	45
1 300	-	27	29	33	38	46
1 400	-	27	29	33	39	46
1 500	-	28	30	34	39	47
1 600	-	28	30	34	40	47
1 700	-	28	30	34	40	47
1 800	-	29	31	35	40	48
1 900	-	29	31	35	40	48
2 000	-	29	31	35	41	48
2 100	-	29	32	36	42	49
2 200	-	30	32	36	42	49
2 300	-	30	32	36	42	49
2 400	-	30	32	36	42	49
2 500	-	30	33	37	43	50
2 600	-	30	33	37	43	50
2 700	-	31	33	37	43	50
2 800	-	31	33	37	43	50
2 900	-	31	33	37	43	51
3 000	-	31	34	38	44	51
3 200	-	32	34	38	44	51
3 400	-	32	34	38	44	51
3 600	-	32	35	39	45	52
3 800	-	32	35	39	45	52
4 000	-	33	35	39	45	52
4 200	-	33	35	39	45	53
4 400	-	33	36	40	46	53
4 600	-	33	36	40	46	53
4 800	-	34	36	40	46	53

Q[W] 55/45/20 °C (ΔT=30 °C)

Length L [mm]	Speed [-] / Heating output [W]					
	0 V	2 V	4 V	6 V	8 V	10 V
700	44	164	269	360	438	502
800	54	219	359	480	584	669
900	65	263	430	576	700	802
1 000	76	372	610	816	992	1 137
1 100	87	372	610	816	992	1 137
1 200	97	438	718	961	1 167	1 338
1 300	108	482	789	1 056	1 284	1 471
1 400	119	536	879	1 177	1 430	1 638
1 500	130	591	969	1 297	1 576	1 806
1 600	140	644	1 055	1 412	1 715	1 966
1 700	151	644	1 055	1 412	1 715	1 966
1 800	162	745	1 220	1 633	1 984	2 274
1 900	173	808	1 324	1 773	2 153	2 467
2 000	183	863	1 413	1 892	2 299	2 635
2 100	194	907	1 485	1 989	2 416	2 768
2 200	205	907	1 485	1 989	2 416	2 768
2 300	216	1 017	1 665	2 229	2 708	3 103
2 400	227	1 017	1 665	2 229	2 708	3 103
2 500	237	1 082	1 773	2 373	2 883	3 303
2 600	248	1 126	1 844	2 469	2 999	3 437
2 700	259	1 170	1 916	2 565	3 116	3 571
2 800	270	1 235	2 023	2 709	3 291	3 771
2 900	280	1 288	2 109	2 824	3 432	3 932
3 000	291	1 288	2 109	2 824	3 432	3 932
3 200	313	1 453	2 379	3 184	3 869	4 433
3 400	334	1 507	2 469	3 304	4 015	4 600
3 600	356	1 661	2 719	3 641	4 424	5 068
3 800	377	1 715	2 809	3 761	4 570	5 235
4 000	399	1 814	2 971	3 977	4 832	5 536
4 200	420	1 932	3 165	4 236	5 147	5 897
4 400	442	2 033	3 330	4 457	5 416	6 205
4 600	463	2 151	3 523	4 717	5 731	6 566
4 800	485	2 195	3 595	4 812	5 847	6 700

Fans input power [W]*

Length L [mm]	Number of fans	Speed [-] / Fans input power [W]*				
		2 V	4 V	6 V	8 V	10 V
700	1	1	1	2	2	3
800	1	1	1	2	3	4
900	1	1	2	2	3	5
1 000	1	1	2	3	4	6
1 100	1	1	2	3	4	6
1 200	2	2	2	4	5	8
1 300	2	2	3	4	6	9
1 400	2	2	3	4	6	9
1 500	2	2	3	4	7	10
1 600	1	1	2	3	6	10
1 700	2	2	3	4	7	11
1 800	2	2	3	5	8	12
1 900	2	2	3	4	7	12
2 000	2	2	3	5	8	13
2 100	2	2	3	5	8	14
2 200	2	2	3	5	8	14
2 300	2	2	3	5	9	16
2 400	2	2	3	5	9	16
2 500	3	3	4	6	10	17
2 600	3	3	4	6	11	18
2 700	3	3	4	6	11	19
2 800	3	3	4	7	12	19
2 900	2	2	3	5	11	19
3 000	3	3	4	7	12	20
3 200	3	3	4	6	12	22
3 400	3	3	4	7	13	23
3 600	3	3	5	7	14	25
3 800	4	4	6	8	15	26
4 000	4	4	6	9	16	28
4 200	3	3	5	8	16	28
4 400	4	4	6	10	18	31
4 600	4	4	6	9	18	32
4 800	4	4	6	9	18	33

* Approximate fan input powers / When using electrothermal actuator add in the trench heater's power 3 W

FRT 0110 0175

TRENCH HEATER WITH FAN



- › Flats, detached houses, offices, administrative buildings
- › Narrow trench heater suitable for a standard floor
- › High heating output
- › Continuous speed control
- › Quiet operation
- › Common electricity consumption **2 W/m**
- › Using in dry environment



Technical data

Trench heater

Height [H]	110 mm
Width [W]	175 mm
Length [L]	700-4800 mm in step 100 mm

Heat exchanger

Type	Al-Cu lamellar
Length	L-295 mm
Connection thread	2xG1/2" inner

Working conditions

Max. temperature	110 °C
Max. overpressure	1 MPa (10 bar)
Protection	IP 20
Ambient conditions	Temp. T = +2 to +40 °C Humidity Rh = 20 to 70%

Trench heater standard equipment

Trough	Galvanized steel trough with surface finish and black spray layer inside, black cover plates of connection
Heat exchanger	Al-Cu lamellar exchanger with air vent valve, black painted
Grille	Design walkable grille according to the customer's choice (stainless grilles surcharge)
Ledge	Made of anodized aluminium, type and colour according to the customer's choice
Fan	Modern tangential fan with 24 V DC EC motor with high efficiency, rotors protection
Assembly elements	Leveling screws for setting up the trough, mounting brackets
Manual	Manual for the progress of work during installation and user manual
Wiring	Electrical wiring diagram of the trench heaters
Mounting board	Cover and the spacer particle board for easy installation
Package	Transport package for protection against damage during transportation and handling

Technical drawing

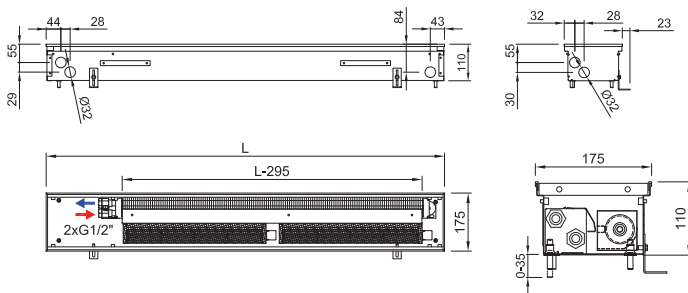

Connection to heating system

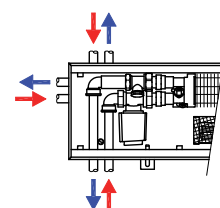

Accessories per order



Variants

Grilles

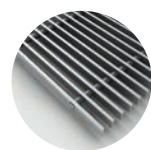

Transverse roll-up

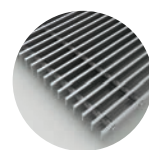

Linear non-rolling

Peripheral ledge

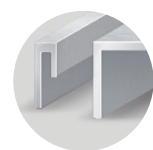

- ① Grilles → 6
 ② Ledges → 8
 ③ Acoustic power → 13
 ④ Accessories → 14
 ⑤ Hydraulic parameters → 126
 ⑥ Wiring → 129

Code example: FRT 0110 0175 1400 C 63 L1 L - 5

Trench heater FRT H = 110 mm, W = 175 mm, L = 1400 mm, „C“ Galvanized steel trough with black inside, heat exchanger and inner parts painted black, „63“ natural oak grille, transverse, roll-up, „L1“ peripheral ledge „L“ with an overlap, natur anodized aluminium, „L“ water connection at the left side (when installing the heat exchanger closer to the window, fans to the room), „5“ 24 V DC fans without controller (controller is not needed)



Trench heater heating output FRT 0110 0175

OPTIMIZED HEAT. OUTPUTS

Q[W] 75/65/20 °C (ΔT=50 °C)

Temperature exponent 1,037

Length L [mm]	Speed [-] / Heating output [W]					
	0 V	2 V	4 V	6 V	8 V	10 V
700	23	79	165	238	299	347
800	28	106	220	317	398	463
900	34	127	264	381	478	556
1 000	40	180	374	539	677	787
1 100	45	180	374	539	677	787
1 200	51	212	440	635	797	926
1 300	57	233	484	698	877	1 019
1 400	62	259	538	777	976	1 135
1 500	68	286	593	857	1 076	1 251
1 600	73	311	646	933	1 171	1 362
1 700	79	311	646	933	1 171	1 362
1 800	85	360	747	1 079	1 355	1 575
1 900	90	391	811	1 171	1 470	1 709
2 000	96	417	866	1 250	1 570	1 825
2 100	102	438	910	1 314	1 650	1 918
2 200	107	438	910	1 314	1 650	1 918
2 300	113	491	1 020	1 472	1 849	2 149
2 400	119	491	1 020	1 472	1 849	2 149
2 500	124	523	1 086	1 567	1 968	2 288
2 600	130	544	1 130	1 631	2 048	2 381
2 700	135	566	1 174	1 694	2 128	2 473
2 800	141	597	1 240	1 789	2 247	2 612
2 900	147	623	1 292	1 866	2 343	2 724
3 000	152	623	1 292	1 866	2 343	2 724
3 200	164	702	1 457	2 104	2 641	3 071
3 400	175	729	1 512	2 183	2 741	3 187
3 600	186	803	1 666	2 405	3 020	3 511
3 800	197	829	1 721	2 484	3 120	3 627
4 000	209	877	1 820	2 627	3 299	3 835
4 200	220	934	1 938	2 798	3 514	4 085
4 400	231	983	2 039	2 944	3 697	4 298
4 600	242	1 040	2 158	3 116	3 912	4 548
4 800	254	1 061	2 202	3 179	3 992	4 641

Q[W] 55/45/20 °C (ΔT=30 °C)

Length L [mm]	Speed [-] / Heating output [W]					
	0 V	2 V	4 V	6 V	8 V	10 V
700	11	47	97	140	176	204
800	14	62	130	187	234	273
900	16	75	155	224	281	327
1 000	19	106	220	317	399	463
1 100	22	106	220	317	399	463
1 200	25	125	259	374	469	545
1 300	28	137	285	411	516	600
1 400	30	152	317	457	575	668
1 500	33	168	349	505	634	737
1 600	35	183	380	549	689	802
1 700	38	183	380	549	689	802
1 800	41	212	440	635	798	927
1 900	44	230	477	689	865	1 006
2 000	46	246	510	736	924	1 074
2 100	49	258	536	774	971	1 129
2 200	52	258	536	774	971	1 129
2 300	55	289	601	867	1 089	1 265
2 400	58	289	601	867	1 089	1 265
2 500	60	308	639	923	1 159	1 347
2 600	63	320	665	960	1 206	1 402
2 700	65	333	691	997	1 253	1 456
2 800	68	351	730	1 053	1 323	1 538
2 900	71	367	761	1 099	1 379	1 604
3 000	74	367	761	1 099	1 379	1 604
3 200	79	413	858	1 239	1 555	1 808
3 400	85	429	890	1 285	1 614	1 876
3 600	90	473	981	1 416	1 778	2 067
3 800	95	488	1 013	1 462	1 837	2 135
4 000	101	516	1 072	1 547	1 942	2 258
4 200	107	550	1 141	1 647	2 069	2 405
4 400	112	579	1 200	1 733	2 177	2 531
4 600	117	612	1 271	1 835	2 303	2 678
4 800	123	625	1 296	1 872	2 350	2 732

75/65/20 °C → 75 °C inlet temperature, 65 °C outlet temp., 20 °C room temp. / Output 90/70/20 °C = ~ 1,22 x 75/65/20 °C / Output 70/55/20 °C = ~ 0,84 x 75/65/20 °C. / Heating outputs in accordance with EN 16430 / Not listed heating outputs for lengths per 100 mm steps calculate linearly. Exact values can be found at www.isan.cz



Acoustic power [dB(A)]

Length L [mm]	Speed [-] / Acoustic power [dB(A)]					
	0 V	2 V	4 V	6 V	8 V	10 V
700	-	< 25	< 25	< 25	29	35
800	-	< 25	< 25	26	30	35
900	-	< 25	< 25	26	30	36
1 000	-	< 25	< 25	27	31	36
1 100	-	< 25	< 25	27	31	37
1 200	-	< 25	< 25	27	31	37
1 300	-	< 25	< 25	27	31	37
1 400	-	< 25	< 25	28	32	38
1 500	-	< 25	< 25	28	32	38
1 600	-	< 25	< 25	28	32	38
1 700	-	< 25	< 25	28	32	38
1 800	-	< 25	< 25	28	33	39
1 900	-	< 25	25	29	33	39
2 000	-	< 25	25	29	33	39
2 100	-	< 25	25	29	33	39
2 200	-	< 25	26	29	33	39
2 300	-	< 25	26	29	33	39
2 400	-	< 25	26	29	34	40
2 500	-	< 25	26	29	34	40
2 600	-	< 25	26	29	34	40
2 700	-	< 25	26	30	34	40
2 800	-	< 25	26	30	34	40
2 900	-	< 25	26	30	34	40
3 000	-	< 25	26	30	34	40
3 200	-	< 25	27	30	35	41
3 400	-	< 25	27	30	35	41
3 600	-	< 25	27	31	35	41
3 800	-	25	27	31	35	41
4 000	-	25	27	31	36	42
4 200	-	25	28	31	36	42
4 400	-	26	28	31	36	42
4 600	-	26	28	31	36	42
4 800	-	26	28	32	36	42



Fans input power [W]*

Length L [mm]	Number of fans	Speed [-] / Fans input power [W]*				
		2 V	4 V	6 V	8 V	10 V
700	1	1	1	2	2	3
800	1	1	1	2	3	4
900	1	1	2	2	3	5
1 000	1	1	2	3	4	6
1 100	1	1	2	3	4	6
1 200	2	2	2	4	5	8
1 300	2	2	3	4	6	9
1 400	2	2	3	4	6	9
1 500	2	2	3	4	7	10
1 600	1	1	2	3	6	10
1 700	2	2	3	4	7	11
1 800	2	2	3	5	8	12
1 900	2	2	3	4	7	12
2 000	2	2	3	5	8	13
2 100	2	2	3	5	8	14
2 200	2	2	3	5	8	14
2 300	2	2	3	5	9	16
2 400	2	2	3	5	9	16
2 500	3	3	4	6	10	17
2 600	3	3	4	6	11	18
2 700	3	3	4	6	11	19
2 800	3	3	4	7	12	19
2 900	2	2	3	5	11	19
3 000	3	3	4	7	12	20
3 200	3	3	4	6	12	22
3 400	3	3	4	7	13	23
3 600	3	3	5	7	14	25
3 800	4	4	6	8	15	26
4 000	4	4	6	9	16	28
4 200	3	3	5	8	16	28
4 400	4	4	6	10	18	31
4 600	4	4	6	9	18	32
4 800	4	4	6	9	18	33

* Approximate fan input powers / When using electrothermal actuator add in the trench heater's power 3 W

FRT 0110 0200

TRENCH HEATER WITH FAN



- > Flats, detached houses, offices, administrative buildings
- > Narrow trench heater suitable for a standard floor
- > High heating output
- > Continuous speed control
- > Quiet operation
- > Common electricity consumption **3 W/m**
- > Using in dry environment



Technical data

Trench heater

Height [H]	110 mm
Width [W]	200 mm
Length [L]	700-4800 mm in step 100 mm

Heat exchanger

Type	Al-Cu lamellar
Length	L-295 mm
Connection thread	2xG1/2" inner

Working conditions

Max. temperature	110 °C
Max. overpressure	1 MPa (10 bar)
Protection	IP 20
Ambient conditions	Temp. T = +2 to +40 °C Humidity Rh = 20 to 70%

Trench heater standard equipment

Trough	Galvanized steel trough with surface finish and black spray layer inside, black cover plates of connection
Heat exchanger	Al-Cu lamellar exchanger with air vent valve, black painted
Grille	Design walkable grille according the customer's choice (stainless grilles surcharge)
Ledge	Made of anodized aluminium, type and colour according the customer's choice
Fan	Modern tangential fan with 24 V DC EC motor with high efficiency, rotors protection
Assembly elements	Leveling screws for setting up the trough, mounting brackets
Manual	Manual for the progress of work during installation and user manual
Wiring	Electrical wiring diagram of the trench heaters
Mounting board	Cover and the spacer particle board for easy installation
Package	Transport package for protection against damage during transportation and handling

Technical drawing

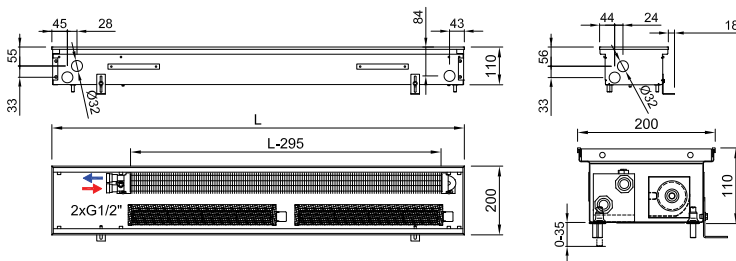

Connection to heating system

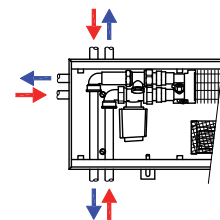

Accessories per order



Variants

Grilles

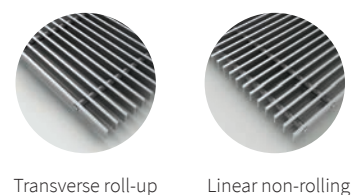

Peripheral ledge



① Grilles → 6 ② Ledges → 8 ③ Acoustic power → 13 ④ Accessories → 14 ⑤ Hydraulic parameters → 126 ⑥ Wiring → 129

Code example: FRT 0110 0200 1900 C 52 J1 R - 5

Trench heater **FRT** H = 110 mm, W = 200 mm, L = 1900 mm, „C“ Galvanized steel trough with black inside, heat exchanger and inner parts painted black, „52“ stainless grille, transverse, roll-up, „J1“ peripheral ledge „J“, natur anodized aluminium, „R“ water connection at the right side (when installing the heat exchanger closer to the window, fans to the room), „5“ 24 V DC fans without controller (controller is not needed)



Trench heater heating output FRT 0110 0200

OPTIMIZED HEAT. OUTPUTS

Q[W] 75/65/20 °C (ΔT=50 °C)

Temperature exponent 1,1

Length L [mm]	Speed [-] / Heating output [W]					
	0 V	2 V	4 V	6 V	8 V	10 V
700	56	196	326	439	536	616
800	70	261	434	585	715	822
900	84	313	521	703	858	986
1 000	98	444	738	995	1215	1397
1 100	111	444	738	995	1215	1397
1 200	125	522	868	1171	1429	1644
1 300	139	574	955	1288	1572	1808
1 400	153	639	1064	1434	1751	2013
1 500	167	704	1172	1581	1930	2219
1 600	181	767	1277	1721	2101	2416
1 700	194	757	1259	1698	2073	2383
1 800	208	887	1476	1991	2430	2794
1 900	222	963	1602	2160	2637	3033
2 000	236	1028	1711	2307	2816	3238
2 100	250	1080	1798	2424	2959	3402
2 200	264	1080	1798	2424	2959	3402
2 300	278	1211	2015	2717	3316	3813
2 400	291	1211	2015	2717	3316	3813
2 500	305	1289	2145	2892	3530	4060
2 600	319	1341	2232	3009	3673	4224
2 700	333	1393	2319	3126	3816	4389
2 800	347	1472	2449	3302	4031	4635
2 900	361	1534	2553	3442	4202	4832
3 000	374	1534	2553	3442	4202	4832
3 200	402	1730	2879	3882	4738	5449
3 400	430	1795	2987	4028	4917	5654
3 600	457	1978	3291	4438	5417	6229
3 800	485	2043	3400	4584	5596	6435
4 000	513	2160	3595	4848	5917	6805
4 200	541	2301	3830	5164	6303	7248
4 400	568	2421	4029	5433	6632	7626
4 600	596	2562	4264	5749	7018	8070
4 800	624	2614	4351	5866	7161	8235

Q[W] 55/45/20 °C (ΔT=30 °C)

Length L [mm]	Speed [-] / Heating output [W]					
	0 V	2 V	4 V	6 V	8 V	10 V
700	27	115	191	258	315	362
800	34	153	255	344	420	483
900	41	184	306	413	504	579
1 000	47	261	433	584	714	820
1 100	54	261	433	584	714	820
1 200	61	307	510	688	839	965
1 300	67	337	561	756	923	1062
1 400	74	375	625	842	1028	1182
1 500	81	413	688	928	1133	1303
1 600	88	450	750	1011	1234	1419
1 700	94	445	739	997	1217	1399
1 800	101	521	867	1169	1427	1641
1 900	107	566	941	1268	1549	1781
2 000	114	604	1005	1355	1654	1902
2 100	121	634	1056	1424	1738	1998
2 200	128	634	1056	1424	1738	1998
2 300	135	711	1183	1596	1947	2239
2 400	141	711	1183	1596	1947	2239
2 500	148	757	1260	1698	2073	2384
2 600	154	788	1311	1767	2157	2481
2 700	161	818	1362	1836	2241	2578
2 800	168	864	1438	1939	2367	2722
2 900	175	901	1499	2021	2468	2838
3 000	181	901	1499	2021	2468	2838
3 200	195	1016	1691	2280	2782	3200
3 400	208	1054	1754	2366	2888	3320
3 600	221	1162	1933	2606	3181	3658
3 800	235	1200	1997	2692	3286	3779
4 000	248	1268	2111	2847	3475	3996
4 200	262	1351	2249	3033	3702	4256
4 400	275	1422	2366	3191	3895	4478
4 600	289	1505	2504	3376	4121	4739
4 800	302	1535	2555	3445	4205	4836

75/65/20 °C → 75 °C inlet temperature, 65 °C outlet temp., 20 °C room temp. / Output 90/70/20 °C = ~ 1,22 x 75/65/20 °C / Output 70/55/20 °C = ~ 0,84 x 75/65/20 °C. / Heating outputs in accordance with EN 16430 / Not listed heating outputs for lengths per 100 mm steps calculate linearly. Exact values can be found at www.isan.cz



Acoustic power [dB(A)]

Length L [mm]	Speed [-] / Acoustic power [dB(A)]					
	0 V	2 V	4 V	6 V	8 V	10 V
700	-	<25	25	30	35	42
800	-	<25	26	30	36	43
900	-	<25	26	31	37	44
1 000	-	<25	27	32	38	45
1 100	-	<25	27	32	38	45
1 200	-	<25	27	33	39	46
1 300	-	<25	28	33	40	46
1 400	-	<25	28	33	40	47
1 500	-	<25	29	34	41	47
1 600	-	<25	29	34	41	48
1 700	-	<25	29	35	41	48
1 800	-	<25	29	35	41	48
1 900	-	<25	30	35	42	49
2 000	-	<25	30	36	42	49
2 100	-	<25	30	36	43	49
2 200	-	<25	30	36	43	50
2 300	-	<25	30	37	43	50
2 400	-	<25	31	37	44	50
2 500	-	<25	31	37	44	51
2 600	-	<25	31	38	44	51
2 700	-	<25	31	38	44	51
2 800	-	<25	31	38	45	51
2 900	-	<25	31	38	45	52
3 000	-	<25	32	38	45	52
3 200	-	<25	32	39	46	52
3 400	-	<25	32	39	46	53
3 600	-	<25	32	39	46	53
3 800	-	<25	33	40	47	53
4 000	-	<25	33	40	47	54
4 200	-	<25	33	41	47	54
4 400	-	<25	33	41	48	54
4 600	-	<25	33	41	48	55
4 800	-	25	34	42	49	55



Fans input power [W]*

Length L [mm]	Number of fans	Speed [-] / Fans input power [W]*				
		2 V	4 V	6 V	8 V	10 V
700	1	1	1	2	2	3
800	1	1	1	2	3	4
900	1	1	2	2	3	5
1 000	1	1	2	3	4	6
1 100	1	1	2	3	4	6
1 200	2	2	2	4	5	8
1 300	2	2	3	4	6	9
1 400	2	2	3	4	6	9
1 500	2	2	3	4	7	10
1 600	1	1	2	3	6	10
1 700	2	2	3	4	7	11
1 800	2	2	3	5	8	12
1 900	2	2	3	4	7	12
2 000	2	2	3	5	8	13
2 100	2	2	3	5	8	14
2 200	2	2	3	5	8	14
2 300	2	2	3	5	9	16
2 400	2	2	3	5	9	16
2 500	3	3	4	6	10	17
2 600	3	3	4	6	11	18
2 700	3	3	4	6	11	19
2 800	3	3	4	7	12	19
2 900	2	2	3	5	11	19
3 000	3	3	4	7	12	20
3 200	3	3	4	6	12	22
3 400	3	3	4	7	13	23
3 600	3	3	5	7	14	25
3 800	4	4	6	8	15	26
4 000	4	4	6	9	16	28
4 200	3	3	5	8	16	28
4 400	4	4	6	10	18	31
4 600	4	4	6	9	18	32
4 800	4	4	6	9	18	33

* Approximate fan input powers / When using electrothermal actuator add in the trench heater's power 3 W

FRT 0110 0250

TRENCH HEATER WITH FAN

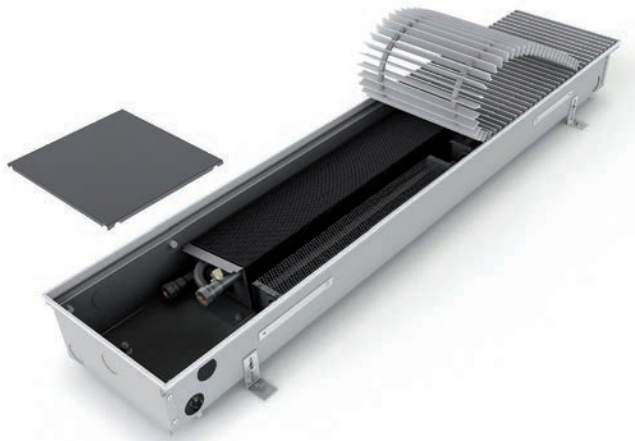

- Flats, detached houses, offices, administrative buildings
- Narrow trench heater suitable for a standard floor
- High heating output
- Continuous speed control
- Quiet operation
- Common electricity consumption **3 W/m**
- Using in dry environment

Technical data

Trench heater

Height [H]	110 mm
Width [W]	250 mm
Length [L]	700-4 800 mm in step 100 mm

Heat exchanger

Type	Al-Cu lamellar
Length	L-295 mm
Connection thread	2×G1/2" inner

Working conditions

Max. temperature	110 °C
Max. overpressure	1 MPa (10 bar)
Protection	IP 20
Ambient conditions	Temp. T = +2 to +40 °C Humidity Rh = 20 to 70%

Trench heater standard equipment

Trough	Galvanized steel trough with surface finish and black spray layer inside, black cover plates of connection
Heat exchanger	Al-Cu lamellar exchanger with air vent valve, black painted
Grille	Design walkable grille according the customer's choice (stainless grilles surcharge)
Ledge	Made of anodized aluminium, type and colour according the customer's choice
Fan	Modern tangential fan with 24 V DC EC motor with high efficiency, rotors protection
Assembly elements	Leveling screws for setting up the trough, mounting brackets
Manual	Manual for the progress of work during installation and user manual
Wiring	Electrical wiring diagram of the trench heaters
Mounting board	Cover and the spacer particle board for easy installation
Package	Transport package for protection against damage during transportation and handling

Technical drawing

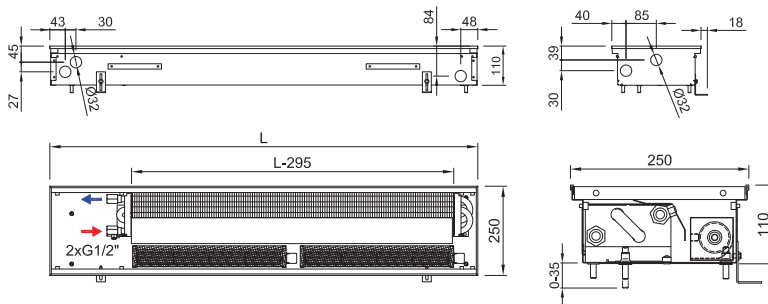

Connection to heating system

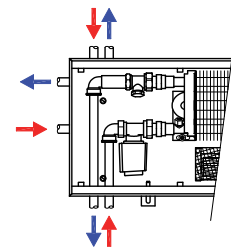

Accessories per order



Variants

Grilles

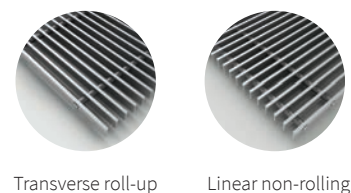

Peripheral ledge

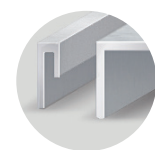

① Grilles → 6 ② Ledges → 8 ③ Acoustic power → 13 ④ Accessories → 14 ⑤ Hydraulic parameters → 126 ⑥ Wiring → 129

Code example: FRT 0110 0250 1500 C 62 L2 L - 5

Trench heater **FRT** H = 110 mm, W = 250 mm, L = 1 500 mm, „C“ Galvanized steel trough with black inside, heat exchanger and inner parts painted black, „62“ stained beech grille, transverse, roll-up, „L2“ peripheral ledge „L“ with an overlap, bronze anodized aluminium, „L“ water connection at the left side (when installing the heat exchanger closer to the window, fans to the room) „5“ 24 V DC fans without controller (controller is not needed)



Trench heater heating output FRT 0110 0250

OPTIMIZED HEAT. OUTPUTS

Q[W] 75/65/20 °C (ΔT=50 °C)

Temperature exponent 1,031

Length L [mm]	Speed [-] / Heating output [W]					
	0 V	2 V	4 V	6 V	8 V	10 V
700	82	220	435	621	778	906
800	102	293	580	828	1 038	1 209
900	123	351	696	994	1 245	1 450
1 000	143	498	986	1 408	1 764	2 055
1 100	163	498	986	1 408	1 764	2 055
1 200	184	585	1 160	1 657	2 076	2 417
1 300	204	644	1 276	1 822	2 283	2 659
1 400	224	717	1 421	2 029	2 543	2 961
1 500	245	790	1 566	2 236	2 802	3 263
1 600	265	861	1 705	2 435	3 051	3 553
1 700	285	861	1 705	2 435	3 051	3 553
1 800	305	995	1 971	2 816	3 528	4 109
1 900	326	1 080	2 140	3 056	3 829	4 460
2 000	346	1 153	2 285	3 263	4 089	4 762
2 100	366	1 212	2 400	3 428	4 296	5 004
2 200	387	1 212	2 400	3 428	4 296	5 004
2 300	407	1 358	2 690	3 843	4 815	5 608
2 400	427	1 358	2 690	3 843	4 815	5 608
2 500	447	1 446	2 864	4 091	5 127	5 971
2 600	468	1 505	2 980	4 257	5 334	6 212
2 700	488	1 563	3 096	4 422	5 542	6 454
2 800	508	1 651	3 270	4 671	5 853	6 817
2 900	529	1 721	3 409	4 870	6 102	7 107
3 000	549	1 721	3 409	4 870	6 102	7 107
3 200	590	1 941	3 844	5 491	6 881	8 013
3 400	630	2 014	3 989	5 698	7 140	8 315
3 600	671	2 219	4 395	6 278	7 866	9 161
3 800	711	2 292	4 540	6 485	8 126	9 464
4 000	752	2 424	4 801	6 857	8 593	10 008
4 200	792	2 582	5 114	7 305	9 153	10 660
4 400	833	2 717	5 381	7 686	9 631	11 216
4 600	874	2 875	5 694	8 133	10 191	11 869
4 800	914	2 933	5 810	8 298	10 399	12 111

Q[W] 55/45/20 °C (ΔT=30 °C)

Length L [mm]	Speed [-] / Heating output [W]					
	0 V	2 V	4 V	6 V	8 V	10 V
700	40	130	257	367	459	535
800	49	173	343	489	613	714
900	60	207	411	587	735	856
1 000	69	294	582	832	1 042	1 214
1 100	79	294	582	832	1 042	1 214
1 200	89	345	685	979	1 226	1 427
1 300	99	380	754	1 076	1 348	1 570
1 400	108	423	839	1 198	1 502	1 749
1 500	119	467	925	1 321	1 655	1 927
1 600	128	508	1 007	1 438	1 802	2 098
1 700	138	508	1 007	1 438	1 802	2 098
1 800	148	588	1 164	1 663	2 084	2 427
1 900	158	638	1 264	1 805	2 261	2 634
2 000	168	681	1 349	1 927	2 415	2 812
2 100	177	716	1 417	2 024	2 537	2 955
2 200	187	716	1 417	2 024	2 537	2 955
2 300	197	802	1 589	2 270	2 844	3 312
2 400	207	802	1 589	2 270	2 844	3 312
2 500	216	854	1 691	2 416	3 028	3 526
2 600	227	889	1 760	2 514	3 150	3 669
2 700	236	923	1 828	2 612	3 273	3 812
2 800	246	975	1 931	2 759	3 457	4 026
2 900	256	1 016	2 013	2 876	3 604	4 197
3 000	266	1 016	2 013	2 876	3 604	4 197
3 200	286	1 146	2 270	3 243	4 064	4 732
3 400	305	1 189	2 356	3 365	4 217	4 911
3 600	325	1 310	2 596	3 708	4 645	5 410
3 800	344	1 354	2 681	3 830	4 799	5 589
4 000	364	1 432	2 835	4 050	5 075	5 910
4 200	383	1 525	3 020	4 314	5 406	6 296
4 400	403	1 605	3 178	4 539	5 688	6 624
4 600	423	1 698	3 363	4 803	6 019	7 010
4 800	443	1 732	3 431	4 901	6 141	7 152

75/65/20 °C → 75 °C inlet temperature, 65 °C outlet temp., 20 °C room temp. / Output 90/70/20 °C = ~ 1,22 x 75/65/20 °C / Output 70/55/20 °C = ~ 0,84 x 75/65/20 °C / Heating outputs in accordance with EN 16430 / Not listed heating outputs for lengths per 100 mm steps calculate linearly. Exact values can be found at www.isan.cz

Acoustic power [dB(A)]

Length L [mm]	Speed [-] / Acoustic power [dB(A)]					
	0 V	2 V	4 V	6 V	8 V	10 V
700	-	< 25	26	30	35	42
800	-	< 25	26	30	36	43
900	-	< 25	27	31	36	44
1 000	-	< 25	27	31	38	45
1 100	-	< 25	27	32	39	45
1 200	-	< 25	28	32	39	46
1 300	-	< 25	28	33	40	46
1 400	-	< 25	28	33	40	47
1 500	-	< 25	29	34	41	47
1 600	-	< 25	29	34	41	48
1 700	-	< 25	29	35	41	48
1 800	-	< 25	29	35	42	48
1 900	-	< 25	30	35	42	49
2 000	-	< 25	30	36	42	49
2 100	-	< 25	30	36	43	49
2 200	-	< 25	30	36	43	50
2 300	-	< 25	30	37	43	50
2 400	-	< 25	31	37	44	50
2 500	-	< 25	31	37	44	51
2 600	-	< 25	31	38	44	51
2 700	-	< 25	31	38	44	51
2 800	-	< 25	31	38	45	51
2 900	-	< 25	31	38	45	52
3 000	-	< 25	32	38	45	52
3 200	-	< 25	32	39	46	52
3 400	-	< 25	32	39	46	53
3 600	-	< 25	32	39	46	53
3 800	-	< 25	33	40	47	53
4 000	-	< 25	33	40	47	54
4 200	-	< 25	33	41	47	54
4 400	-	< 25	33	41	48	54
4 600	-	< 25	33	41	48	55
4 800	-	25	34	42	49	55

Fans input power [W]*

Length L [mm]	Number of fans	Speed [-] / Fans input power [W]*				
		2 V	4 V	6 V	8 V	10 V
700	1	1	1	2	2	3
800	1	1	1	2	3	4
900	1	1	2	2	3	5
1 000	1	1	2	3	4	6
1 100	1	1	2	3	4	6
1 200	2	2	2	4	5	8
1 300	2	2	3	4	6	9
1 400	2	2	3	4	6	9
1 500	2	2	3	4	7	10
1 600	1	1	2	3	6	10
1 700	2	2	3	4	7	11
1 800	2	2	3	5	8	12
1 900	2	2	3	4	7	12
2 000	2	2	3	5	8	13
2 100	2	2	3	5	8	14
2 200	2	2	3	5	8	14
2 300	2	2	3	5	9	16
2 400	2	2	3	5	9	16
2 500	3	3	4	6	10	17
2 600	3	3	4	6	11	18
2 700	3	3	4	6	11	19
2 800	3	3	4	7	12	19
2 900	2	2	3	5	11	19
3 000	3	3	4	7	12	20
3 200	3	3	4	6	12	22
3 400	3	3	4	7	13	23
3 600	3	3	5	7	14	25
3 800	4	4	6	8	15	26
4 000	4	4	6	9	16	28
4 200	3	3	5	8	16	28
4 400	4	4	6	10	18	31
4 600	4	4	6	9	18	32
4 800	4	4	6	9	18	33

* Approximate fan input powers / When using electrothermal actuator add in the trench heater's power 3 W

FRT 0110 0300

TRENCH HEATER WITH FAN

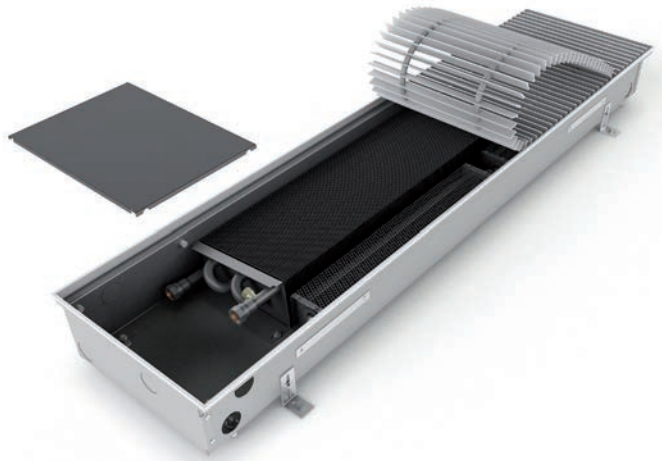

- › Flats, detached houses, offices, administrative buildings
- › Universal trench heater suitable for a standard floor
- › High heating output
- › Continuous speed control
- › Quiet operation
- › Common electricity consumption **3 W/m**
- › Using in dry environment

Technical data

Trench heater

Height [H]	110 mm
Width [W]	300 mm
Length [L]	700-4800 mm in step 100 mm

Heat exchanger

Type	Al-Cu lamellar
Length	L-295 mm
Connection thread	2xG1/2" inner

Working conditions

Max. temperature	110 °C
Max. overpressure	1 MPa (10 bar)
Protection	IP 20
Ambient conditions	Temp. T = +2 to +40 °C Humidity Rh = 20 to 70%

Trench heater standard equipment

Trough	Galvanized steel trough with surface finish and black spray layer inside, black cover plates of connection
Heat exchanger	Al-Cu lamellar exchanger with air vent valve, black painted
Grille	Design walkable grille according the customer's choice (stainless grilles surcharge)
Ledge	Made of anodized aluminium, type and colour according the customer's choice
Fan	Modern tangential fan with 24 V DC EC motor with high efficiency, rotors protection
Assembly elements	Leveling screws for setting up the trough, mounting brackets
Manual	Manual for the progress of work during installation and user manual
Wiring	Electrical wiring diagram of the trench heaters
Mounting board	Cover and the spacer particle board for easy installation
Package	Transport package for protection against damage during transportation and handling

Technical drawing

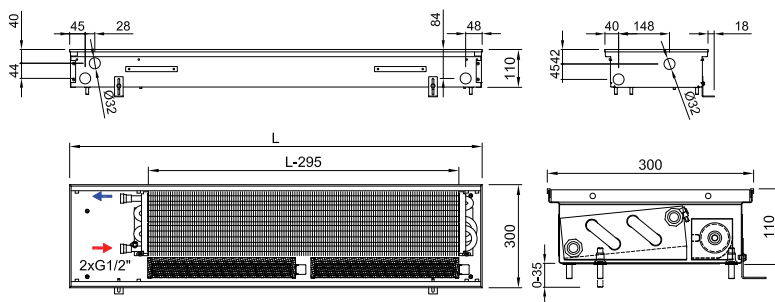

Connection to heating system

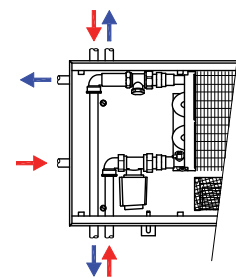

Accessories per order



Variants

Grilles

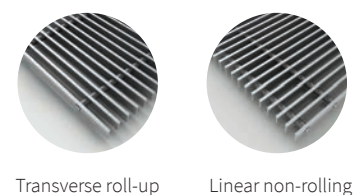

Peripheral ledge

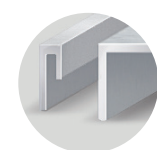

- ① Grilles → 6
 ② Ledges → 8
 ③ Acoustic power → 13
 ④ Accessories → 14
 ⑤ Hydraulic parameters → 126
 ⑥ Wiring → 129

Code example: FRT 0110 0300 2700 C 32 J3 R - 5

Trench heater FRT H=110 mm, W= 300 mm, L=2 700 mm, „C“ Galvanized steel trough with black inside, heat exchanger and inner parts painted black, „32“ black anodized aluminium grille, linear, rigid, „J3“ peripheral ledge „J“, black anodized aluminium „R“ water connection at the right side (when installing the heat exchanger closer to the window, fans to the room), „5“ 24 V DC fans without controller (controller is not needed)



Trench heater heating output FRT 0110 0300

Q[W] 75/65/20 °C (ΔT=50 °C)

Temperature exponent 1,1

Length L [mm]	Speed [-] / Heating output [W]					
	0 V	2 V	4 V	6 V	8 V	10 V
700	115	307	476	637	790	934
800	143	409	635	849	1 053	1 245
900	171	490	762	1 019	1 264	1 494
1 000	200	695	1 079	1 444	1 790	2 117
1 100	228	695	1 079	1 444	1 790	2 117
1 200	256	817	1 269	1 699	2 106	2 490
1 300	285	899	1 396	1 869	2 316	2 739
1 400	313	1 001	1 555	2 081	2 580	3 050
1 500	341	1 103	1 714	2 294	2 843	3 362
1 600	370	1 202	1 866	2 497	3 096	3 661
1 700	398	1 202	1 866	2 497	3 096	3 661
1 800	426	1 390	2 158	2 888	3 580	4 233
1 900	455	1 508	2 342	3 135	3 885	4 594
2 000	483	1 610	2 501	3 347	4 149	4 906
2 100	511	1 692	2 628	3 517	4 359	5 155
2 200	540	1 692	2 628	3 517	4 359	5 155
2 300	568	1 896	2 945	3 942	4 886	5 777
2 400	596	1 896	2 945	3 942	4 886	5 777
2 500	625	2 019	3 136	4 196	5 201	6 151
2 600	653	2 101	3 262	4 366	5 412	6 400
2 700	681	2 182	3 389	4 536	5 623	6 649
2 800	710	2 305	3 580	4 791	5 939	7 022
2 900	738	2 403	3 732	4 995	6 191	7 321
3 000	766	2 403	3 732	4 995	6 191	7 321
3 200	823	2 710	4 208	5 632	6 981	8 255
3 400	880	2 812	4 367	5 844	7 244	8 566
3 600	936	3 098	4 811	6 439	7 981	9 438
3 800	993	3 200	4 970	6 651	8 244	9 749
4 000	1 050	3 384	5 256	7 034	8 718	10 309
4 200	1 106	3 605	5 598	7 492	9 287	10 982
4 400	1 163	3 793	5 890	7 883	9 771	11 554
4 600	1 220	4 013	6 233	8 342	10 340	12 227
4 800	1 276	4 095	6 360	8 512	10 550	12 476

75/65/20 °C → 75 °C inlet temperature, 65 °C outlet temp., 20 °C room temp. / Output 90/70/20 °C = ~ 1,22 x 75/65/20 °C / Output 70/55/20 °C = ~ 0,84 x 75/65/20 °C. / Heating outputs in accordance with EN 16430 / Not listed heating outputs for lengths per 100 mm steps calculate linearly. Exact values can be found at www.isan.cz

Q[W] 55/45/20 °C (ΔT=30 °C)

Length L [mm]	Speed [-] / Heating output [W]					
	0 V	2 V	4 V	6 V	8 V	10 V
700	56	175	271	363	450	532
800	69	233	362	484	600	710
900	83	279	434	581	721	852
1 000	97	396	615	823	1 021	1 207
1 100	110	396	615	823	1 021	1 207
1 200	124	466	723	969	1 201	1 420
1 300	138	513	796	1 066	1 320	1 562
1 400	152	571	887	1 186	1 471	1 739
1 500	165	629	977	1 308	1 621	1 917
1 600	179	685	1 064	1 424	1 765	2 087
1 700	193	685	1 064	1 424	1 765	2 087
1 800	206	792	1 230	1 647	2 041	2 413
1 900	220	860	1 335	1 787	2 215	2 619
2 000	234	918	1 426	1 908	2 365	2 797
2 100	247	965	1 498	2 005	2 485	2 939
2 200	261	965	1 498	2 005	2 485	2 939
2 300	275	1 081	1 679	2 247	2 786	3 294
2 400	289	1 081	1 679	2 247	2 786	3 294
2 500	303	1 151	1 788	2 392	2 965	3 507
2 600	316	1 198	1 860	2 489	3 085	3 649
2 700	330	1 244	1 932	2 586	3 206	3 791
2 800	344	1 314	2 041	2 731	3 386	4 003
2 900	357	1 370	2 128	2 848	3 530	4 174
3 000	371	1 370	2 128	2 848	3 530	4 174
3 200	398	1 545	2 399	3 211	3 980	4 706
3 400	426	1 603	2 490	3 332	4 130	4 884
3 600	453	1 766	2 743	3 671	4 550	5 381
3 800	481	1 824	2 833	3 792	4 700	5 558
4 000	508	1 929	2 997	4 010	4 970	5 877
4 200	535	2 055	3 192	4 271	5 295	6 261
4 400	563	2 162	3 358	4 494	5 571	6 587
4 600	591	2 288	3 554	4 756	5 895	6 971
4 800	618	2 335	3 626	4 853	6 015	7 113

Acoustic power [dB(A)]

Length L [mm]	Speed [-] / Acoustic power [dB(A)]					
	0 V	2 V	4 V	6 V	8 V	10 V
700	-	<25	25	30	35	42
800	-	<25	26	30	36	43
900	-	<25	26	31	37	44
1 000	-	<25	27	32	38	45
1 100	-	<25	27	32	38	45
1 200	-	<25	27	33	39	46
1 300	-	<25	28	33	40	46
1 400	-	<25	28	33	40	47
1 500	-	<25	29	34	41	47
1 600	-	<25	29	34	41	48
1 700	-	<25	29	35	41	48
1 800	-	<25	29	35	41	48
1 900	-	<25	30	35	42	49
2 000	-	<25	30	36	42	49
2 100	-	<25	30	36	43	49
2 200	-	<25	30	36	43	50
2 300	-	<25	30	37	43	50
2 400	-	<25	31	37	44	50
2 500	-	<25	31	37	44	51
2 600	-	<25	31	38	44	51
2 700	-	<25	31	38	44	51
2 800	-	<25	31	38	45	51
2 900	-	<25	31	38	45	52
3 000	-	<25	32	38	45	52
3 200	-	<25	32	39	46	52
3 400	-	<25	32	39	46	53
3 600	-	<25	32	39	46	53
3 800	-	<25	33	40	47	53
4 000	-	<25	33	40	47	54
4 200	-	<25	33	41	47	54
4 400	-	<25	33	41	48	54
4 600	-	<25	33	41	48	55
4 800	-	25	34	42	49	55

Fans input power [W]*

Length L [mm]	Number of fans	Speed [-] / Fans input power [W]*				
		2 V	4 V	6 V	8 V	10 V
700	1	1	1	2	2	3
800	1	1	1	2	3	4
900	1	1	2	2	3	5
1 000	1	1	2	3	4	6
1 100	1	1	2	3	4	6
1 200	2	2	2	4	5	8
1 300	2	2	3	4	6	9
1 400	2	2	3	4	6	9
1 500	2	2	3	4	7	10
1 600	1	1	2	3	6	10
1 700	2	2	3	4	7	11
1 800	2	2	3	5	8	12
1 900	2	2	3	4	7	12
2 000	2	2	3	5	8	13
2 100	2	2	3	5	8	14
2 200	2	2	3	5	8	14
2 300	2	2	3	5	9	16
2 400	2	2	3	5	9	16
2 500	3	3	4	6	10	17
2 600	3	3	4	6	11	18
2 700	3	3	4	6	11	19
2 800	3	3	4	7	12	19
2 900	2	2	3	5	11	19
3 000	3	3	4	7	12	20
3 200	3	3	4	6	12	22
3 400	3	3	4	7	13	23
3 600	3	3	5	7	14	25
3 800	4	4	6	8	15	26
4 000	4	4	6	9	16	28
4 200	3	3	5	8	16	28
4 400	4	4	6	10	18	31
4 600	4	4	6	9	18	32
4 800	4	4	6	9	18	33

* Approximate fan input powers / When using electrothermal actuator add in the trench heater's power 3 W

FRT 0110 0425

TRENCH HEATER WITH FAN



- › Flats, detached houses, offices, administrative buildings
- › Suitable for low-temperature systems
- › High heating output
- › Continuous speed control
- › Quiet operation
- › Common electricity consumption **3 W/m**
- › Using in dry environment

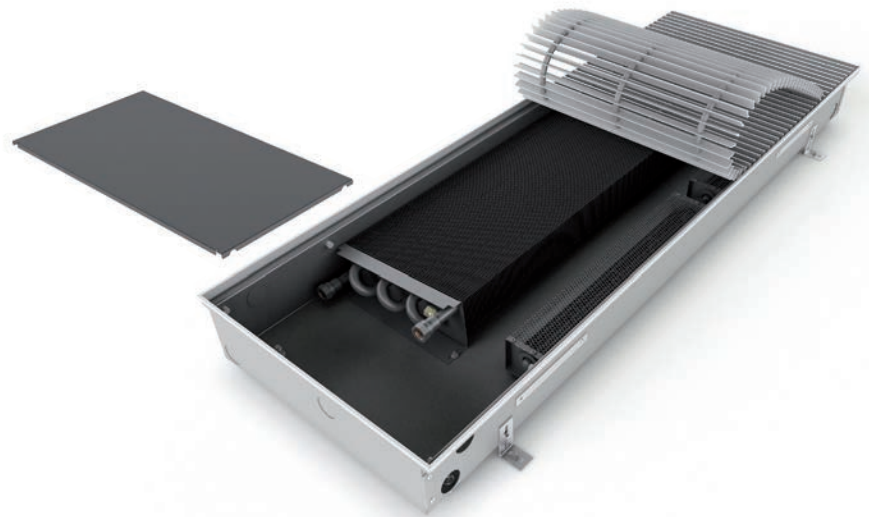

Technical data

Trench heater

Height [H]	110 mm
Width [W]	425 mm
Length [L]	700-4800 mm in step 100 mm

Heat exchanger

Type	Al-Cu lamellar
Length	L-295 mm
Connection thread	2xG1/2" inner

Working conditions

Max. temperature	110 °C
Max. overpressure	1 MPa (10 bar)
Protection	IP 20
Ambient conditions	Temp. T = +2 to +40 °C Humidity Rh = 20 to 70%

Trench heater standard equipment

Trough	Galvanized steel trough with surface finish and black spray layer inside, black cover plates of connection
Heat exchanger	Al-Cu lamellar exchanger with air vent valve, black painted
Grille	Design walkable grille according the customer's choice (stainless grilles surcharge)
Ledge	Made of anodized aluminium, type and colour according the customer's choice
Fan	Modern tangential fan with 24 V DC EC motor with high efficiency, rotors protection
Assembly elements	Leveling screws for setting up the trough, mounting brackets
Manual	Manual for the progress of work during installation and user manual
Wiring	Electrical wiring diagram of the trench heaters
Mounting board	Cover and the spacer particle board for easy installation
Package	Transport package for protection against damage during transportation and handling

Technical drawing

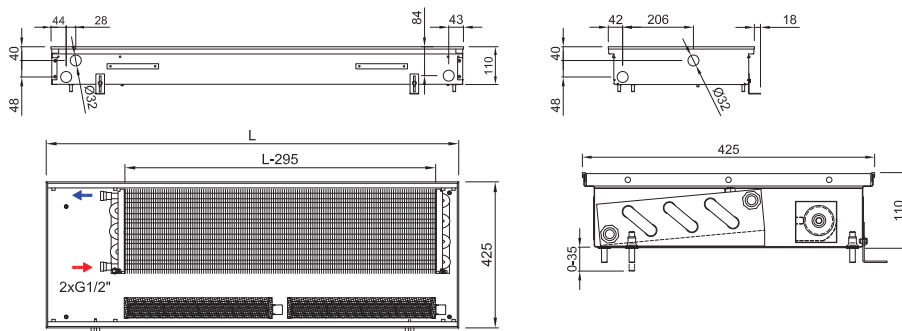

Connection to heating system

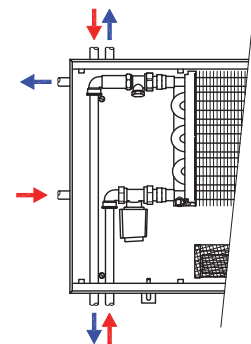

Accessories per order



Variants

Grilles

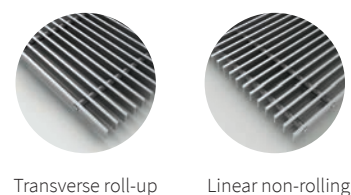

Peripheral ledge

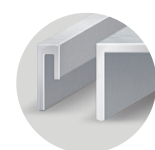

① Grilles → 6 ② Ledges → 8 ③ Acoustic power → 13 ④ Accessories → 14 ⑤ Hydraulic parameters → 126 ⑥ Wiring → 129

Code example: FRT 0110 0425 4400 C 64 L2 L - 5

Trench heater FRT H=110 mm, W= 425 mm, L=4 400 mm, „C“ Galvanized steel trough with black inside, heat exchanger and inner parts painted black, „64“ stained oak grille, transverse, roll-up, „L2“ peripheral ledge, „L“ with an overlap, bronze anodized aluminium, „L“ water connection at the left side (when installing the heat exchanger closer to the window, fans to the room), „5“ 24 V DC fans without controller (controller is not needed)



Trench heater heating output FRT 0110 0425

Q[W] 75/65/20 °C (ΔT=50 °C)

Temperature exponent 1,1

Length L [mm]	Speed [-] / Heating output [W]					
	0 V	2 V	4 V	6 V	8 V	10 V
700	153	409	597	776	945	1 106
800	191	546	796	1 034	1 260	1 474
900	229	655	955	1 241	1 512	1 769
1 000	267	928	1 353	1 758	2 143	2 506
1 100	305	928	1 353	1 758	2 143	2 506
1 200	342	1 092	1 592	2 069	2 521	2 949
1 300	380	1 201	1 751	2 275	2 773	3 244
1 400	418	1 337	1 950	2 534	3 088	3 612
1 500	456	1 474	2 149	2 793	3 403	3 981
1 600	494	1 605	2 341	3 041	3 705	4 335
1 700	532	1 605	2 341	3 041	3 705	4 335
1 800	569	1 856	2 707	3 517	4 285	5 013
1 900	607	2 014	2 938	3 817	4 651	5 440
2 000	645	2 150	3 137	4 075	4 966	5 809
2 100	683	2 260	3 296	4 282	5 218	6 104
2 200	721	2 260	3 296	4 282	5 218	6 104
2 300	758	2 533	3 694	4 799	5 848	6 841
2 400	796	2 533	3 694	4 799	5 848	6 841
2 500	834	2 696	3 933	5 109	6 226	7 283
2 600	872	2 805	4 092	5 316	6 478	7 578
2 700	910	2 915	4 251	5 523	6 730	7 873
2 800	948	3 078	4 490	5 833	7 108	8 315
2 900	985	3 209	4 681	6 082	7 411	8 669
3 000	1 023	3 209	4 681	6 082	7 411	8 669
3 200	1 099	3 619	5 278	6 857	8 356	9 775
3 400	1 175	3 755	5 477	7 116	8 671	10 143
3 600	1 250	4 137	6 034	7 840	9 554	11 176
3 800	1 326	4 274	6 233	8 098	9 869	11 544
4 000	1 402	4 519	6 592	8 564	10 436	12 208
4 200	1 477	4 814	7 022	9 122	11 116	13 004
4 400	1 553	5 065	7 388	9 598	11 696	13 682
4 600	1 629	5 360	7 818	10 157	12 377	14 478
4 800	1 704	5 469	7 977	10 364	12 629	14 773

75/65/20 °C → 75 °C inlet temperature, 65 °C outlet temp., 20 °C room temp. / Output 90/70/20 °C = ~ 1,22 x 75/65/20 °C / Output 70/55/20 °C = ~ 0,84 x 75/65/20 °C. / Heating outputs in accordance with EN 16430 / Not listed heating outputs for lengths per 100 mm steps calculate linearly. Exact values can be found at www.isan.cz

Q[W] 55/45/20 °C (ΔT=30 °C)

Length L [mm]	Speed [-] / Heating output [W]					
	0 V	2 V	4 V	6 V	8 V	10 V
700	74	233	340	442	539	631
800	92	311	454	590	718	840
900	111	373	544	708	862	1 009
1 000	129	529	771	1 002	1 222	1 429
1 100	148	529	771	1 002	1 222	1 429
1 200	166	623	908	1 180	1 437	1 681
1 300	184	685	998	1 297	1 581	1 849
1 400	202	762	1 112	1 445	1 761	2 059
1 500	221	840	1 225	1 592	1 940	2 270
1 600	239	915	1 335	1 734	2 112	2 471
1 700	258	915	1 335	1 734	2 112	2 471
1 800	275	1 058	1 543	2 005	2 443	2 858
1 900	294	1 148	1 675	2 176	2 652	3 101
2 000	312	1 226	1 788	2 323	2 831	3 312
2 100	331	1 288	1 879	2 441	2 975	3 480
2 200	349	1 288	1 879	2 441	2 975	3 480
2 300	367	1 444	2 106	2 736	3 334	3 900
2 400	385	1 444	2 106	2 736	3 334	3 900
2 500	404	1 537	2 242	2 913	3 550	4 152
2 600	422	1 599	2 333	3 031	3 693	4 320
2 700	441	1 662	2 424	3 149	3 837	4 489
2 800	459	1 755	2 560	3 326	4 052	4 741
2 900	477	1 830	2 669	3 467	4 225	4 942
3 000	495	1 830	2 669	3 467	4 225	4 942
3 200	532	2 063	3 009	3 909	4 764	5 573
3 400	569	2 141	3 123	4 057	4 944	5 783
3 600	605	2 359	3 440	4 470	5 447	6 372
3 800	642	2 437	3 554	4 617	5 627	6 581
4 000	679	2 576	3 758	4 883	5 950	6 960
4 200	715	2 745	4 003	5 201	6 337	7 414
4 400	752	2 888	4 212	5 472	6 668	7 800
4 600	789	3 056	4 457	5 791	7 056	8 254
4 800	825	3 118	4 548	5 909	7 200	8 422

Acoustic power [dB(A)]

Length L [mm]	Speed [-] / Acoustic power [dB(A)]					
	0 V	2 V	4 V	6 V	8 V	10 V
700	-	< 25	25	29	34	42
800	-	< 25	26	30	36	43
900	-	25	27	31	36	44
1 000	-	26	27	31	36	44
1 100	-	26	28	32	38	45
1 200	-	26	28	32	38	45
1 300	-	27	29	33	38	46
1 400	-	27	29	33	39	46
1 500	-	28	30	34	39	47
1 600	-	28	30	34	40	47
1 700	-	28	30	34	40	47
1 800	-	29	31	35	40	48
1 900	-	29	31	35	40	48
2 000	-	29	31	35	41	48
2 100	-	29	32	36	42	49
2 200	-	30	32	36	42	49
2 300	-	30	32	36	42	49
2 400	-	30	32	36	42	49
2 500	-	30	33	37	43	50
2 600	-	30	33	37	43	50
2 700	-	31	33	37	43	50
2 800	-	31	33	37	43	50
2 900	-	31	33	37	43	51
3 000	-	31	34	38	44	51
3 200	-	32	34	38	44	51
3 400	-	32	34	38	44	51
3 600	-	32	35	39	45	52
3 800	-	32	35	39	45	52
4 000	-	33	35	39	45	52
4 200	-	33	35	39	45	53
4 400	-	33	36	40	46	53
4 600	-	33	36	40	46	53
4 800	-	34	36	40	46	53

Fans input power [W]*

Length L [mm]	Number of fans	Speed [-] / Fans input power [W]*				
		2 V	4 V	6 V	8 V	10 V
700	1	1	1	2	2	3
800	1	1	1	2	3	4
900	1	1	2	2	3	5
1 000	1	1	2	3	4	6
1 100	1	1	2	3	4	6
1 200	2	2	2	4	5	8
1 300	2	2	3	4	6	9
1 400	2	2	3	4	6	9
1 500	2	2	3	4	7	10
1 600	1	1	2	3	6	10
1 700	2	2	3	4	7	11
1 800	2	2	3	5	8	12
1 900	2	2	3	4	7	12
2 000	2	2	3	5	8	13
2 100	2	2	3	5	8	14
2 200	2	2	3	5	8	14
2 300	2	2	3	5	9	16
2 400	2	2	3	5	9	16
2 500	3	3	4	6	10	17
2 600	3	3	4	6	11	18
2 700	3	3	4	6	11	19
2 800	3	3	4	7	12	19
2 900	2	2	3	5	11	19
3 000	3	3	4	7	12	20
3 200	3	3	4	6	12	22
3 400	3	3	4	7	13	23
3 600	3	3	5	7	14	25
3 800	4	4	6	8	15	26
4 000	4	4	6	9	16	28
4 200	3	3	5	8	16	28
4 400	4	4	6	10	18	31
4 600	4	4	6	9	18	32
4 800	4	4	6	9	18	33

* Approximate fan input powers / When using electrothermal actuator add in the trench heater's power 3 W

FRT 0125 0250

TRENCH HEATER WITH FAN



- › Flats, detached houses, offices, administrative buildings
- › Good balance of heating output and size
- › High heating output
- › Continuous speed control
- › Quiet operation
- › Common electricity consumption **3 W/m**
- › Using in dry environment

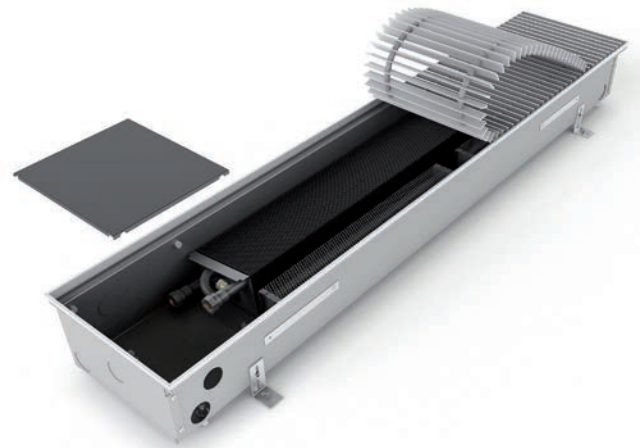

Technical data

Trench heater

Height [H]	125 mm
Width [W]	250 mm
Length [L]	700-4800 mm in step 100 mm

Heat exchanger

Type	Al-Cu lamellar
Length	L-295 mm
Connection thread	2×G1/2" inner

Working conditions

Max. temperature	110 °C
Max. overpressure	1 MPa (10 bar)
Protection	IP 20
Ambient conditions	Temp. T = +2 to +40 °C Humidity Rh = 20 to 70%

Trench heater standard equipment

Trough	Galvanized steel trough with surface finish and black spray layer inside, black cover plates of connection
Heat exchanger	Al-Cu lamellar exchanger with air vent valve, black painted
Grille	Design walkable grille according to the customer's choice (stainless grilles surcharge)
Ledge	Made of anodized aluminium, type and colour according to the customer's choice
Fan	Modern tangential fan with 24 V DC EC motor with high efficiency, rotors protection
Assembly elements	Leveling screws for setting up the trough, mounting brackets
Manual	Manual for the progress of work during installation and user manual
Wiring	Electrical wiring diagram of the trench heaters
Mounting board	Cover and the spacer particle board for easy installation
Package	Transport package for protection against damage during transportation and handling

Technical drawing

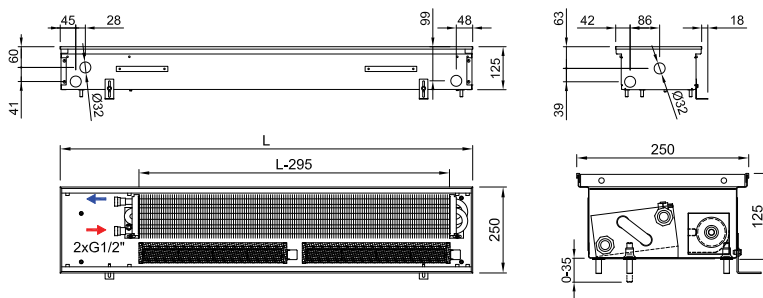

Connection to heating system

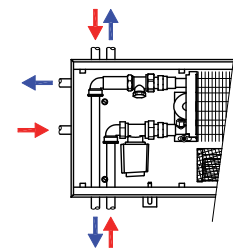

Accessories per order



Variants

Grilles

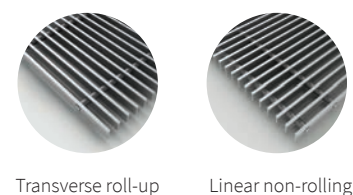

Peripheral ledge

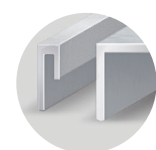

- ① Grilles → 6
 ② Ledges → 8
 ③ Acoustic power → 13
 ④ Accessories → 14
 ⑤ Hydraulic parameters → 126
 ⑥ Wiring → 129

Code example: FRT 0125 0250 1500 C 62 L2 L - 5

Trench heater FRT H = 125 mm, W = 250 mm, L = 1 500 mm, „C“ Galvanized steel trough with black inside, heat exchanger and inner parts painted black, „62“ stained beech grille, transverse, roll-up, „L2“ peripheral ledge, „L“ with an overlap, bronze anodized aluminium, „L“ water connection at the left side (when installing the heat exchanger closer to the window, fans to the room) „5“ 24 V DC fans without controller (controller is not needed)



Trench heater heating output FRT 0125 0250

Q[W] 75/65/20 °C (ΔT=50 °C)

Temperature exponent 1,1

Length L [mm]	Speed [-] / Heating output [W]					
	0 V	2 V	4 V	6 V	8 V	10 V
700	112	298	465	618	758	885
800	139	397	620	825	1 011	1 180
900	167	477	744	989	1 214	1 416
1 000	194	675	1 054	1 402	1 719	2 006
1 100	222	675	1 054	1 402	1 719	2 006
1 200	249	794	1 240	1 649	2 023	2 360
1 300	277	874	1 364	1 814	2 225	2 596
1 400	305	973	1 519	2 020	2 478	2 891
1 500	332	1 072	1 674	2 226	2 730	3 186
1 600	360	1 168	1 822	2 424	2 973	3 469
1 700	387	1 168	1 822	2 424	2 973	3 469
1 800	415	1 351	2 108	2 803	3 438	4 012
1 900	442	1 466	2 287	3 043	3 732	4 354
2 000	470	1 565	2 442	3 249	3 984	4 649
2 100	498	1 644	2 566	3 414	4 187	4 885
2 200	525	1 644	2 566	3 414	4 187	4 885
2 300	553	1 843	2 876	3 826	4 692	5 475
2 400	580	1 843	2 876	3 826	4 692	5 475
2 500	608	1 962	3 062	4 073	4 996	5 829
2 600	635	2 042	3 186	4 238	5 198	6 065
2 700	663	2 121	3 310	4 403	5 400	6 301
2 800	691	2 240	3 496	4 650	5 704	6 655
2 900	718	2 336	3 645	4 848	5 946	6 939
3 000	746	2 336	3 645	4 848	5 946	6 939
3 200	801	2 634	4 110	5 467	6 705	7 824
3 400	856	2 733	4 265	5 673	6 958	8 119
3 600	911	3 011	4 699	6 250	7 665	8 945
3 800	966	3 110	4 853	6 456	7 918	9 240
4 000	1 021	3 289	5 132	6 827	8 373	9 771
4 200	1 076	3 503	5 467	7 272	8 919	10 408
4 400	1 132	3 686	5 752	7 652	9 385	10 951
4 600	1 187	3 901	6 087	8 097	9 931	11 588
4 800	1 242	3 980	6 211	8 262	10 133	11 824

75/65/20 °C → 75 °C inlet temperature, 65 °C outlet temp., 20 °C room temp. / Output 90/70/20 °C = ~ 1,22 x 75/65/20 °C / Output 70/55/20 °C = ~ 0,84 x 75/65/20 °C / Heating outputs in accordance with EN 16430 / Not listed heating outputs for lengths per 100 mm steps calculate linearly. Exact values can be found at www.isan.cz

Acoustic power [dB(A)]

Length L [mm]	Speed [-] / Acoustic power [dB(A)]					
	0 V	2 V	4 V	6 V	8 V	10 V
700	-	< 25	26	30	36	43
800	-	< 25	26	30	37	44
900	-	< 25	27	32	38	45
1 000	-	< 25	27	32	38	45
1 100	-	< 25	27	33	39	46
1 200	-	< 25	28	33	40	47
1 300	-	< 25	28	34	40	47
1 400	-	< 25	29	34	41	48
1 500	-	< 25	29	34	41	48
1 600	-	< 25	29	35	41	48
1 700	-	< 25	30	35	42	49
1 800	-	< 25	30	36	42	49
1 900	-	< 25	30	36	43	50
2 000	-	< 25	30	36	43	50
2 100	-	< 25	31	37	43	50
2 200	-	< 25	31	37	44	51
2 300	-	< 25	31	37	44	51
2 400	-	< 25	31	38	44	51
2 500	-	< 25	31	38	45	51
2 600	-	< 25	31	38	45	52
2 700	-	< 25	32	38	45	52
2 800	-	< 25	32	39	45	52
2 900	-	< 25	32	39	46	52
3 000	-	25	32	39	46	53
3 200	-	25	32	39	46	53
3 400	-	25	33	40	47	53
3 600	-	25	33	40	47	54
3 800	-	25	33	41	47	54
4 000	-	26	34	41	48	54
4 200	-	26	34	41	48	55
4 400	-	26	34	42	48	55
4 600	-	26	34	42	49	55
4 800	-	26	34	42	49	56

Q[W] 55/45/20 °C (ΔT=30 °C)

Length L [mm]	Speed [-] / Heating output [W]					
	0 V	2 V	4 V	6 V	8 V	10 V
700	54	170	265	352	432	505
800	67	226	353	470	576	673
900	81	272	424	564	692	807
1 000	94	385	601	799	980	1 144
1 100	107	385	601	799	980	1 144
1 200	121	453	707	940	1 153	1 345
1 300	134	498	778	1 034	1 269	1 480
1 400	148	555	866	1 152	1 413	1 648
1 500	161	611	954	1 269	1 556	1 816
1 600	174	666	1 039	1 382	1 695	1 978
1 700	187	666	1 039	1 382	1 695	1 978
1 800	201	770	1 202	1 598	1 960	2 287
1 900	214	836	1 304	1 735	2 128	2 482
2 000	228	892	1 392	1 852	2 271	2 650
2 100	241	937	1 463	1 946	2 387	2 785
2 200	254	937	1 463	1 946	2 387	2 785
2 300	268	1 051	1 640	2 181	2 675	3 121
2 400	281	1 051	1 640	2 181	2 675	3 121
2 500	294	1 119	1 746	2 322	2 848	3 323
2 600	307	1 164	1 816	2 416	2 963	3 458
2 700	321	1 209	1 887	2 510	3 079	3 592
2 800	335	1 277	1 993	2 651	3 252	3 794
2 900	348	1 332	2 078	2 764	3 390	3 956
3 000	361	1 332	2 078	2 764	3 390	3 956
3 200	388	1 502	2 343	3 117	3 823	4 461
3 400	414	1 558	2 432	3 234	3 967	4 629
3 600	441	1 717	2 679	3 563	4 370	5 100
3 800	468	1 773	2 767	3 681	4 514	5 268
4 000	494	1 875	2 926	3 892	4 774	5 571
4 200	521	1 997	3 117	4 146	5 085	5 934
4 400	548	2 101	3 279	4 363	5 351	6 243
4 600	575	2 224	3 470	4 616	5 662	6 607
4 800	601	2 269	3 541	4 710	5 777	6 741

Fans input power [W]*

Length L [mm]	Number of fans	Speed [-] / Fans input power [W]*				
		2 V	4 V	6 V	8 V	10 V
700	1	1	1	2	2	3
800	1	1	1	2	3	4
900	1	1	2	2	3	5
1 000	1	1	2	3	4	6
1 100	1	1	2	3	4	6
1 200	2	2	2	4	5	8
1 300	2	2	3	4	6	9
1 400	2	2	3	4	6	9
1 500	2	2	3	4	7	10
1 600	1	1	2	3	6	10
1 700	2	2	3	4	7	11
1 800	2	2	3	5	8	12
1 900	2	2	3	4	7	12
2 000	2	2	3	5	8	13
2 100	2	2	3	5	8	14
2 200	2	2	3	5	8	14
2 300	2	2	3	5	9	16
2 400	2	2	3	5	9	16
2 500	3	3	4	6	10	17
2 600	3	3	4	6	11	18
2 700	3	3	4	6	11	19
2 800	3	3	4	7	12	19
2 900	2	2	3	5	11	19
3 000	3	3	4	7	12	20
3 200	3	3	4	6	12	22
3 400	3	3	4	7	13	23
3 600	3	3	5	7	14	25
3 800	4	4	6	8	15	26
4 000	4	4	6	9	16	28
4 200	3	3	5	8	16	28
4 400	4	4	6	10	18	31
4 600	4	4	6	9	18	32
4 800	4	4	6	9	18	33

* Approximate fan input powers / When using electrothermal actuator add in the trench heater's power 3 W

FRT 0125 0300

TRENCH HEATER WITH FAN

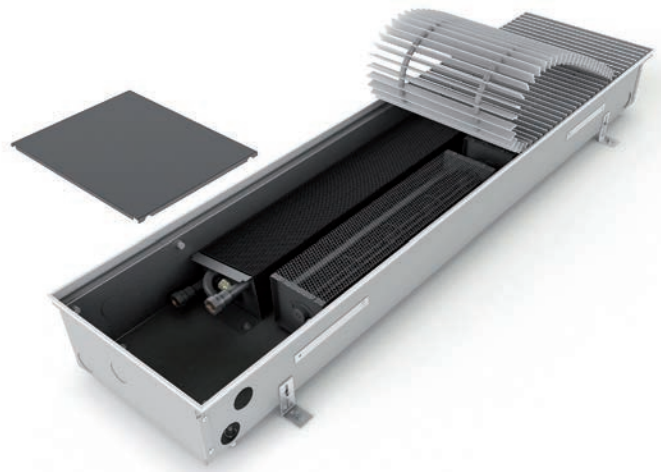

- › Flats, detached houses, offices, administrative buildings
- › Suitable for low-temperature systems
- › High heating output
- › Continuous speed control
- › Quiet operation
- › Common electricity consumption **2 W/m**
- › Using in dry environment

Technical data

Trench heater

Height [H]	125 mm
Width [W]	300 mm
Length [L]	700-4800 mm in step 100 mm

Heat exchanger

Type	Al-Cu lamellar
Length	L-295 mm
Connection thread	2xG1/2" inner

Working conditions

Max. temperature	110 °C
Max. overpressure	1 MPa (10 bar)
Protection	IP 20
Ambient conditions	Temp. T = +2 to +40 °C Humidity Rh = 20 to 70%

Trench heater standard equipment

Trough	Galvanized steel trough with surface finish and black spray layer inside, black cover plates of connection
Heat exchanger	Al-Cu lamellar exchanger with air vent valve, black painted
Grille	Design walkable grille according the customer's choice (stainless grilles surcharge)
Ledge	Made of anodized aluminium, type and colour according the customer's choice
Fan	Modern tangential fan with 24 V DC EC motor with high efficiency, rotors protection
Assembly elements	Leveling screws for setting up the trough, mounting brackets
Manual	Manual for the progress of work during installation and user manual
Wiring	Electrical wiring diagram of the trench heaters
Mounting board	Cover and the spacer particle board for easy installation
Package	Transport package for protection against damage during transportation and handling

Technical drawing

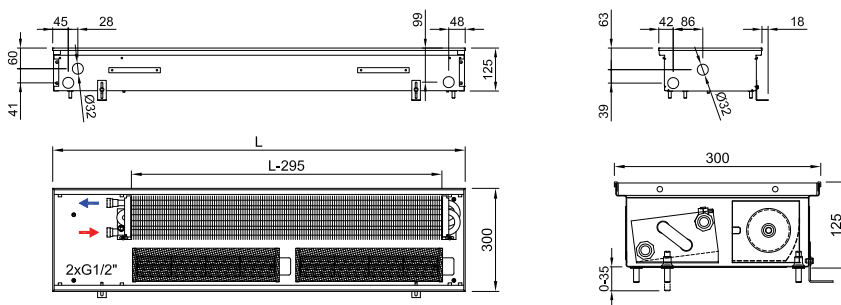

Connection to heating system

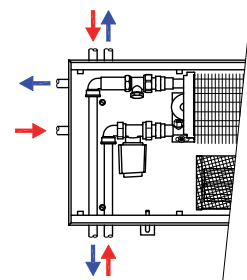

Accessories per order



Variants

Grilles

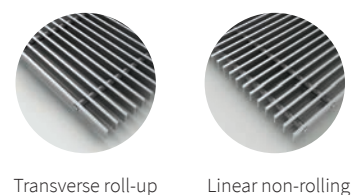

Peripheral ledge



- ① Grilles → 6
 ② Ledges → 8
 ③ Acoustic power → 13
 ④ Accessories → 14
 ⑤ Hydraulic parameters → 126
 ⑥ Wiring → 129

Code example: FRT 0125 0300 2700 C 32 J3 R - 5

Trench heater **FRT** H=125 mm, W=300 mm, L=2 700 mm, „**C**“ Galvanized steel trough with black inside, heat exchanger and inner parts painted black, „**32**“ black anodized aluminium grille, linear, rigid, „**J3**“ peripheral ledge „**J**“, black anodized aluminium „**R**“ water connection at the right side (when installing the heat exchanger closer to the window, fans to the room), „**5**“ 24 V DC fans without controller (controller is not needed)



Trench heater heating output FRT 0125 0300

Q[W] 75/65/20 °C (ΔT=50 °C)

Temperature exponent 1,1

Length L [mm]	Speed [-] / Heating output [W]					
	0 V	2 V	4 V	6 V	8 V	10 V
700	132	354	638	859	1 016	1 109
800	164	473	853	1 148	1 358	1 483
900	197	592	1 068	1 437	1 700	1 856
1 000	229	775	1 396	1 879	2 223	2 428
1 100	262	775	1 396	1 879	2 223	2 428
1 200	294	946	1 706	2 295	2 715	2 966
1 300	327	1 065	1 921	2 585	3 057	3 339
1 400	359	1 129	2 034	2 738	3 239	3 537
1 500	392	1 248	2 249	3 027	3 581	3 911
1 600	424	1 375	2 479	3 336	3 947	4 310
1 700	457	1 375	2 479	3 336	3 947	4 310
1 800	489	1 549	2 793	3 758	4 446	4 856
1 900	522	1 729	3 117	4 195	4 962	5 420
2 000	554	1 848	3 332	4 484	5 304	5 793
2 100	586	1 967	3 547	4 773	5 646	6 167
2 200	619	1 967	3 547	4 773	5 646	6 167
2 300	651	2 150	3 875	5 215	6 170	6 738
2 400	684	2 150	3 875	5 215	6 170	6 738
2 500	716	2 321	4 185	5 632	6 662	7 276
2 600	749	2 441	4 400	5 921	7 004	7 650
2 700	781	2 560	4 614	6 210	7 346	8 023
2 800	814	2 623	4 728	6 363	7 527	8 221
2 900	846	2 750	4 958	6 672	7 893	8 621
3 000	879	2 750	4 958	6 672	7 893	8 621
3 200	944	3 104	5 596	7 531	8 909	9 730
3 400	1 009	3 224	5 811	7 820	9 251	10 104
3 600	1 074	3 525	6 355	8 552	10 116	11 049
3 800	1 139	3 697	6 664	8 968	10 609	11 587
4 000	1 204	3 935	7 094	9 546	11 293	12 334
4 200	1 269	4 126	7 437	10 009	11 840	12 931
4 400	1 334	4 300	7 751	10 431	12 339	13 477
4 600	1 399	4 599	8 290	11 156	13 198	14 414
4 800	1 464	4 718	8 505	11 446	13 540	14 788

75/65/20 °C → 75 °C inlet temperature, 65 °C outlet temp., 20 °C room temp. / Output 90/70/20 °C = ~ 1,22 x 75/65/20 °C / Output 70/55/20 °C = ~ 0,84 x 75/65/20 °C / Heating outputs in accordance with EN 16430 / Not listed heating outputs for lengths per 100 mm steps calculate linearly. Exact values can be found at www.isan.cz

Q[W] 55/45/20 °C (ΔT=30 °C)

Length L [mm]	Speed [-] / Heating output [W]					
	0 V	2 V	4 V	6 V	8 V	10 V
700	64	202	364	490	579	632
800	79	270	486	654	774	845
900	95	338	609	819	969	1 058
1 000	111	442	796	1 071	1 267	1 384
1 100	127	442	796	1 071	1 267	1 384
1 200	142	539	973	1 308	1 548	1 691
1 300	158	607	1 095	1 474	1 743	1 904
1 400	174	644	1 160	1 561	1 847	2 017
1 500	190	712	1 282	1 726	2 042	2 230
1 600	205	784	1 413	1 902	2 250	2 457
1 700	221	784	1 413	1 902	2 250	2 457
1 800	237	883	1 592	2 143	2 535	2 769
1 900	253	986	1 777	2 392	2 829	3 090
2 000	268	1 054	1 900	2 556	3 024	3 303
2 100	284	1 121	2 022	2 721	3 219	3 516
2 200	300	1 121	2 022	2 721	3 219	3 516
2 300	315	1 226	2 209	2 973	3 518	3 841
2 400	331	1 226	2 209	2 973	3 518	3 841
2 500	347	1 323	2 386	3 211	3 798	4 148
2 600	363	1 392	2 509	3 376	3 993	4 361
2 700	378	1 460	2 631	3 540	4 188	4 574
2 800	394	1 495	2 696	3 628	4 291	4 687
2 900	410	1 568	2 827	3 804	4 500	4 915
3 000	426	1 568	2 827	3 804	4 500	4 915
3 200	457	1 770	3 190	4 294	5 079	5 547
3 400	489	1 838	3 313	4 458	5 274	5 760
3 600	520	2 010	3 623	4 876	5 767	6 299
3 800	551	2 108	3 799	5 113	6 048	6 606
4 000	583	2 243	4 044	5 442	6 438	7 032
4 200	614	2 352	4 240	5 706	6 750	7 372
4 400	646	2 452	4 419	5 947	7 035	7 684
4 600	677	2 622	4 726	6 360	7 524	8 218
4 800	709	2 690	4 849	6 526	7 719	8 431

Acoustic power [dB(A)]

Length L [mm]	Speed [-] / Acoustic power [dB(A)]					
	0 V	2 V	4 V	6 V	8 V	10 V
700	-	< 25	35	43	51	57
800	-	< 25	35	44	51	57
900	-	26	36	44	52	58
1 000	-	26	36	45	52	58
1 100	-	27	37	45	52	58
1 200	-	27	37	45	53	59
1 300	-	28	37	46	53	59
1 400	-	28	38	46	53	59
1 500	-	29	38	46	54	60
1 600	-	29	38	47	54	60
1 700	-	29	38	47	54	60
1 800	-	29	38	47	54	60
1 900	-	30	39	47	55	61
2 000	-	30	39	47	55	61
2 100	-	30	39	48	55	61
2 200	-	31	40	48	55	61
2 300	-	31	40	48	55	61
2 400	-	31	40	48	55	62
2 500	-	31	40	48	56	62
2 600	-	31	40	48	56	62
2 700	-	32	40	48	56	62
2 800	-	32	41	49	56	62
2 900	-	32	41	49	56	62
3 000	-	32	41	49	56	62
3 200	-	32	41	49	57	63
3 400	-	33	41	49	57	63
3 600	-	33	42	50	57	63
3 800	-	33	42	50	57	63
4 000	-	34	42	50	57	64
4 200	-	34	42	50	57	64
4 400	-	34	42	50	57	64
4 600	-	34	43	51	58	64
4 800	-	35	43	51	58	64

Fans input power [W]*

Length L [mm]	Number of fans	Speed [-] / Fans input power [W]*				
		2 V	4 V	6 V	8 V	10 V
700	1	1	2	3	1	7
800	1	1	2	3	6	9
900	1	1	2	5	8	12
1 000	1	1	3	6	14	18
1 100	1	1	3	6	14	18
1 200	2	2	4	6	12	17
1 300	2	2	4	8	14	21
1 400	2	2	5	8	14	25
1 500	2	2	5	8	20	27
1 600	1	2	5	10	19	26
1 700	2	2	5	10	21	30
1 800	2	2	6	11	27	36
1 900	2	3	6	13	19	32
2 000	2	3	6	13	25	34
2 100	2	3	7	15	26	37
2 200	2	3	7	15	26	37
2 300	2	3	7	15	32	44
2 400	2	3	7	15	32	44
2 500	3	4	8	16	31	43
2 600	3	4	8	18	32	46
2 700	3	4	9	19	33	49
2 800	3	4	9	18	38	52
2 900	2	4	9	20	37	51
3 000	3	4	9	20	39	55
3 200	3	5	11	23	37	58
3 400	3	5	11	23	43	60
3 600	3	5	12	25	50	69
3 800	4	6	12	27	45	69
4 000	4	6	13	29	51	74
4 200	3	6	13	30	55	77
4 400	4	6	14	30	63	87
4 600	4	7	15	33	61	85
4 800	4	7	15	34	62	88

* Approximate fan input powers / When using electrothermal actuator add in the trench heater's power 3 W

FRT 0125 0425

TRENCH HEATER WITH FAN



- › Flats, detached houses, offices, administrative buildings
- › Suitable for low-temperature systems
- › High heating output
- › Continuous speed control
- › Quiet operation
- › Common electricity consumption **2 W/m**
- › Using in dry environment

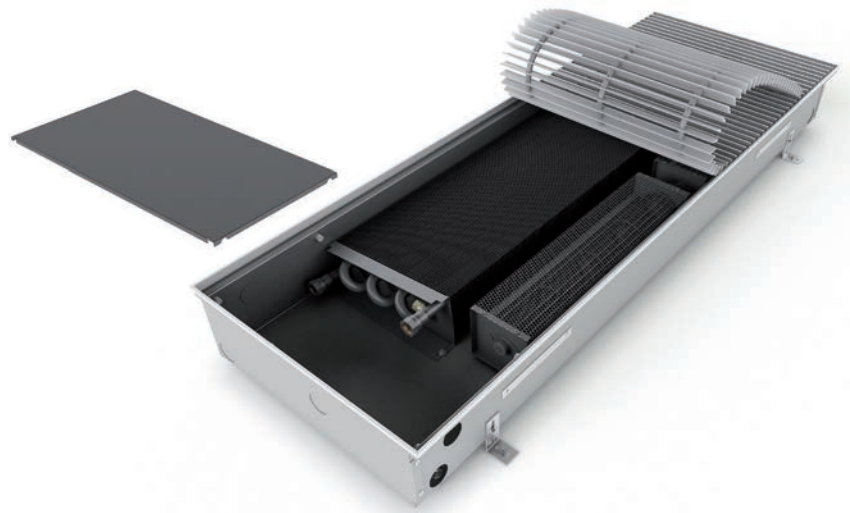

Technical data

Trench heater

Height [H]	125 mm
Width [W]	425 mm
Length [L]	700-4 800 mm in step 100 mm

Heat exchanger

Type	Al-Cu lamellar
Length	L-295 mm
Connection thread	2xG1/2" inner

Working conditions

Max. temperature	110 °C
Max. overpressure	1 MPa (10 bar)
Protection	IP 20
Ambient conditions	Temp. T = +2 to +40 °C Humidity Rh = 20 to 70%

Trench heater standard equipment

Trough	Galvanized steel trough with surface finish and black spray layer inside, black cover plates of connection
Heat exchanger	Al-Cu lamellar exchanger with air vent valve, black painted
Grille	Design walkable grille according the customer's choice (stainless grilles surcharge)
Ledge	Made of anodized aluminium, type and colour according the customer's choice
Fan	Modern tangential fan with 24 V DC EC motor with high efficiency, rotors protection
Assembly elements	Leveling screws for setting up the trough, mounting brackets
Manual	Manual for the progress of work during installation and user manual
Wiring	Electrical wiring diagram of the trench heaters
Mounting board	Cover and the spacer particle board for easy installation
Package	Transport package for protection against damage during transportation and handling

Technical drawing

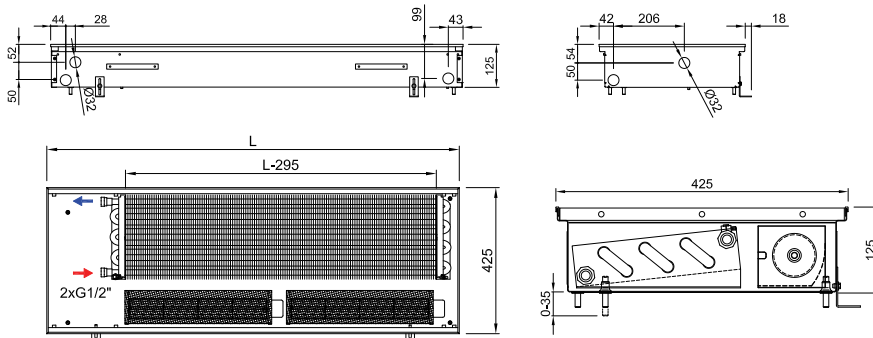

Connection to heating system

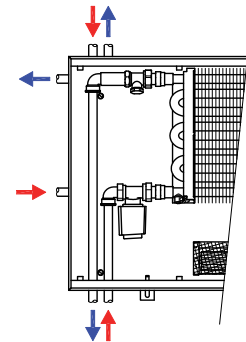

Accessories per order



Variants

Grilles

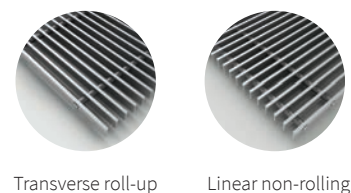

Peripheral ledge

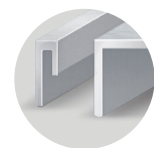

① Grilles → 6 ② Ledges → 8 ③ Acoustic power → 13 ④ Accessories → 14 ⑤ Hydraulic parameters → 126 ⑥ Wiring → 129

Code example: FRT 0125 0425 4400 C 64 L2 L - 5

Trench heater FRT H = 125 mm, W = 425 mm, L = 4 400 mm, „C“ Galvanized steel trough with black inside, heat exchanger and inner parts painted black, „64“ stained oak grille, transverse, roll-up, „L2“ peripheral ledge, „L“ with an overlap, bronze anodized aluminium, „L“ water connection at the left side (when installing the heat exchanger closer to the window, fans to the room), „5“ 24 V DC fans without controller (controller is not needed)



Trench heater heating output FRT 0125 0425

Q[W] 75/65/20 °C (ΔT=50 °C)

Temperature exponent 1,1

Length L [mm]	Speed [-] / Heating output [W]					
	0 V	2 V	4 V	6 V	8 V	10 V
700	202	709	1 005	1 255	1 459	1 616
800	252	948	1 344	1 678	1 950	2 160
900	302	1 187	1 683	2 101	2 441	2 704
1 000	352	1 552	2 201	2 747	3 193	3 536
1 100	402	1 552	2 201	2 747	3 193	3 536
1 200	452	1 896	2 688	3 356	3 900	4 319
1 300	502	2 134	3 027	3 779	4 391	4 863
1 400	552	2 261	3 206	4 003	4 651	5 152
1 500	602	2 500	3 545	4 425	5 143	5 696
1 600	652	2 755	3 907	4 878	5 668	6 278
1 700	702	2 755	3 907	4 878	5 668	6 278
1 800	752	3 104	4 401	5 495	6 385	7 072
1 900	802	3 464	4 912	6 133	7 127	7 894
2 000	852	3 703	5 251	6 556	7 618	8 438
2 100	902	3 942	5 589	6 978	8 109	8 982
2 200	952	3 942	5 589	6 978	8 109	8 982
2 300	1 002	4 307	6 107	7 625	8 861	9 814
2 400	1 052	4 307	6 107	7 625	8 861	9 814
2 500	1 102	4 651	6 595	8 234	9 568	10 597
2 600	1 152	4 890	6 933	8 656	10 059	11 141
2 700	1 202	5 128	7 272	9 079	10 550	11 685
2 800	1 252	5 255	7 451	9 303	10 811	11 974
2 900	1 302	5 510	7 814	9 755	11 336	12 556
3 000	1 352	5 510	7 814	9 755	11 336	12 556
3 200	1 452	6 220	8 819	11 011	12 795	14 172
3 400	1 552	6 458	9 158	11 433	13 286	14 716
3 600	1 652	7 062	10 014	12 503	14 529	16 092
3 800	1 751	7 406	10 502	13 112	15 236	16 875
4 000	1 851	7 884	11 179	13 957	16 218	17 963
4 200	1 951	8 266	11 720	14 633	17 004	18 834
4 400	2 051	8 614	12 215	15 250	17 721	19 628
4 600	2 151	9 214	13 064	16 311	18 954	20 993
4 800	2 251	9 452	13 403	16 734	19 445	21 537

75/65/20 °C → 75 °C inlet temperature, 65 °C outlet temp., 20 °C room temp. / Output 90/70/20 °C = ~ 1,22 x 75/65/20 °C / Output 70/55/20 °C = ~ 0,84 x 75/65/20 °C / Heating outputs in accordance with EN 16430 / Not listed heating outputs for lengths per 100 mm steps calculate linearly. Exact values can be found at www.isan.cz

Q[W] 55/45/20 °C (ΔT=30 °C)

Length L [mm]	Speed [-] / Heating output [W]					
	0 V	2 V	4 V	6 V	8 V	10 V
700	98	404	573	716	832	921
800	122	540	766	957	1 112	1 231
900	146	677	960	1 198	1 392	1 542
1 000	170	885	1 255	1 566	1 820	2 016
1 100	195	885	1 255	1 566	1 820	2 016
1 200	219	1 081	1 532	1 913	2 223	2 462
1 300	243	1 217	1 726	2 154	2 503	2 772
1 400	267	1 289	1 828	2 282	2 652	2 937
1 500	291	1 425	2 021	2 523	2 932	3 247
1 600	316	1 571	2 227	2 781	3 231	3 579
1 700	340	1 571	2 227	2 781	3 231	3 579
1 800	364	1 770	2 509	3 133	3 640	4 032
1 900	388	1 975	2 800	3 497	4 063	4 501
2 000	412	2 111	2 994	3 738	4 343	4 811
2 100	437	2 247	3 186	3 978	4 623	5 121
2 200	461	2 247	3 186	3 978	4 623	5 121
2 300	485	2 456	3 482	4 347	5 052	5 595
2 400	509	2 456	3 482	4 347	5 052	5 595
2 500	534	2 652	3 760	4 694	5 455	6 042
2 600	558	2 788	3 953	4 935	5 735	6 352
2 700	582	2 924	4 146	5 176	6 015	6 662
2 800	606	2 996	4 248	5 304	6 164	6 827
2 900	630	3 141	4 455	5 562	6 463	7 158
3 000	655	3 141	4 455	5 562	6 463	7 158
3 200	703	3 546	5 028	6 278	7 295	8 080
3 400	751	3 682	5 221	6 518	7 575	8 390
3 600	800	4 026	5 709	7 128	8 283	9 174
3 800	848	4 222	5 987	7 475	8 686	9 621
4 000	896	4 495	6 373	7 957	9 246	10 241
4 200	945	4 713	6 682	8 343	9 694	10 738
4 400	993	4 911	6 964	8 694	10 103	11 190
4 600	1 041	5 253	7 448	9 299	10 806	11 969
4 800	1 090	5 389	7 641	9 540	11 086	12 279

Acoustic power [dB(A)]

Length L [mm]	Speed [-] / Acoustic power [dB(A)]					
	0 V	2 V	4 V	6 V	8 V	10 V
700	-	<25	35	45	52	58
800	-	26	36	45	53	59
900	-	27	37	46	53	59
1 000	-	27	37	46	54	60
1 100	-	28	38	46	54	60
1 200	-	28	38	47	54	61
1 300	-	29	39	47	55	61
1 400	-	29	39	48	55	61
1 500	-	29	39	48	55	62
1 600	-	30	39	48	55	62
1 700	-	30	40	48	56	62
1 800	-	30	40	49	56	62
1 900	-	31	40	49	56	62
2 000	-	31	40	49	56	63
2 100	-	31	40	49	56	63
2 200	-	31	41	49	57	63
2 300	-	32	41	50	57	63
2 400	-	32	41	50	57	63
2 500	-	32	41	50	57	64
2 600	-	32	41	50	57	64
2 700	-	33	41	50	57	64
2 800	-	33	42	50	58	64
2 900	-	33	42	50	58	64
3 000	-	33	42	51	58	64
3 200	-	33	42	51	58	65
3 400	-	34	42	51	58	65
3 600	-	34	43	51	58	65
3 800	-	34	43	51	59	65
4 000	-	35	44	52	59	65
4 200	-	35	44	52	59	66
4 400	-	35	44	52	59	66
4 600	-	35	44	52	59	66
4 800	-	36	44	52	59	66

Fans input power [W]*

Length L [mm]	Number of fans	Speed [-] / Fans input power [W]*				
		2 V	4 V	6 V	8 V	10 V
700	1	1	2	3	1	7
800	1	1	2	3	6	9
900	1	1	2	5	8	12
1 000	1	1	3	6	14	18
1 100	1	1	3	6	14	18
1 200	2	2	4	6	12	17
1 300	2	2	4	8	14	21
1 400	2	2	5	8	14	25
1 500	2	2	5	8	20	27
1 600	1	2	5	10	19	26
1 700	2	2	5	10	21	30
1 800	2	2	6	11	27	36
1 900	2	3	6	13	19	32
2 000	2	3	6	13	25	34
2 100	2	3	7	15	26	37
2 200	2	3	7	15	26	37
2 300	2	3	7	15	32	44
2 400	2	3	7	15	32	44
2 500	3	4	8	16	31	43
2 600	3	4	8	18	32	46
2 700	3	4	9	19	33	49
2 800	3	4	9	18	38	52
2 900	2	4	9	20	37	51
3 000	3	4	9	20	39	55
3 200	3	5	11	23	37	58
3 400	3	5	11	23	43	60
3 600	3	5	12	25	50	69
3 800	4	6	12	27	45	69
4 000	4	6	13	29	51	74
4 200	3	6	13	30	55	77
4 400	4	6	14	30	63	87
4 600	4	7	15	33	61	85
4 800	4	7	15	34	62	88

* Approximate fan input powers / When using electrothermal actuator add in the trench heater's power 3 W

FRT 0140 0250

TRENCH HEATER WITH FAN



- › Flats, detached houses, offices, administrative buildings
- › Narrow trench heater suitable for deeper floor
- › High heating output
- › Continuous speed control
- › Quiet operation
- › Common electricity consumption **3 W/m**
- › Using in dry environment

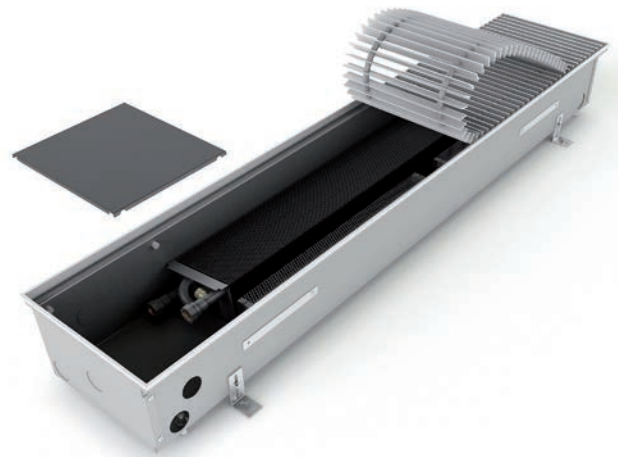

Technical data

Trench heater

Height [H]	140 mm
Width [W]	250 mm
Length [L]	700-4 800 mm in step 100 mm

Heat exchanger

Type	Al-Cu lamellar
Length	L-295 mm
Connection thread	2xG1/2" inner

Working conditions

Max. temperature	110 °C
Max. overpressure	1 MPa (10 bar)
Protection	IP 20
Ambient conditions	Temp. T = +2 to +40 °C Humidity Rh = 20 to 70%

Trench heater standard equipment

Trough	Galvanized steel trough with surface finish and black spray layer inside, black cover plates of connection
Heat exchanger	Al-Cu lamellar exchanger with air vent valve, black painted
Grille	Design walkable grille according the customer's choice (stainless grilles surcharge)
Ledge	Made of anodized aluminium, type and colour according the customer's choice
Fan	Modern tangential fan with 24 V DC EC motor with high efficiency, rotors protection
Assembly elements	Leveling screws for setting up the trough, mounting brackets
Manual	Manual for the progress of work during installation and user manual
Wiring	Electrical wiring diagram of the trench heaters
Mounting board	Cover and the spacer particle board for easy installation
Package	Transport package for protection against damage during transportation and handling

Technical drawing

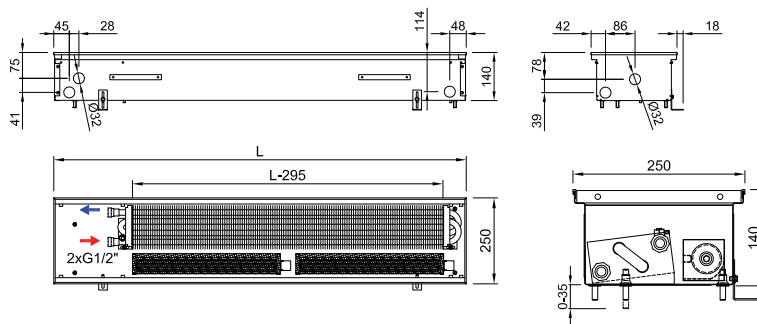

Connection to heating system

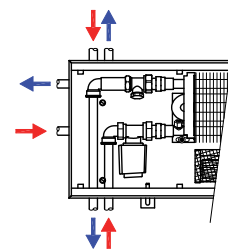

Accessories per order



Variants

Grilles

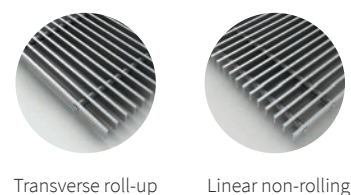

Peripheral ledge

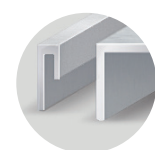

① Grilles → 6 ② Ledges → 8 ③ Acoustic power → 13 ④ Accessories → 14 ⑤ Hydraulic parameters → 126 ⑥ Wiring → 129

Code example: FRT 00140 0250 1500 C 62 L2 L - 5

Trench heater FRT H=140 mm, W=250 mm, L=1 500 mm, „C“ Galvanized steel trough with black inside, heat exchanger and inner parts painted black, „62“ stained beech grille, transverse, roll-up, „L2“ peripheral ledge „L“ with an overlap, bronze anodized aluminium, „L“ water connection at the left side (when installing the heat exchanger closer to the window, fans to the room) „5“ 24 V DC fans without controller (controller is not needed)



Trench heater heating output FRT 0140 0250

Q[W] 75/65/20 °C (ΔT=50 °C)

Temperature exponent 1,1

Length L [mm]	Speed [-] / Heating output [W]					
	0 V	2 V	4 V	6 V	8 V	10 V
700	89	309	488	653	804	941
800	110	412	651	871	1 072	1 254
900	132	494	781	1 045	1 287	1 505
1 000	154	700	1 106	1 481	1 823	2 132
1 100	176	700	1 106	1 481	1 823	2 132
1 200	198	823	1 302	1 742	2 144	2 509
1 300	220	906	1 432	1 916	2 359	2 760
1 400	242	1 009	1 594	2 134	2 627	3 073
1 500	264	1 111	1 757	2 352	2 895	3 387
1 600	285	1 210	1 913	2 561	3 152	3 688
1 700	307	1 210	1 913	2 561	3 152	3 688
1 800	329	1 400	2 213	2 961	3 645	4 265
1 900	351	1 519	2 401	3 214	3 956	4 629
2 000	373	1 622	2 564	3 431	4 224	4 942
2 100	395	1 704	2 694	3 606	4 439	5 193
2 200	417	1 704	2 694	3 606	4 439	5 193
2 300	439	1 910	3 020	4 041	4 975	5 820
2 400	461	1 910	3 020	4 041	4 975	5 820
2 500	482	2 034	3 215	4 302	5 296	6 196
2 600	504	2 116	3 345	4 477	5 511	6 447
2 700	526	2 198	3 475	4 651	5 725	6 698
2 800	548	2 322	3 670	4 912	6 047	7 075
2 900	570	2 420	3 827	5 121	6 304	7 376
3 000	592	2 420	3 827	5 121	6 304	7 376
3 200	636	2 729	4 315	5 774	7 108	8 316
3 400	679	2 832	4 477	5 992	7 376	8 630
3 600	723	3 120	4 933	6 602	8 127	9 508
3 800	767	3 223	5 096	6 819	8 395	9 822
4 000	811	3 408	5 388	7 211	8 877	10 386
4 200	854	3 631	5 740	7 682	9 456	11 063
4 400	898	3 820	6 039	8 082	9 949	11 640
4 600	942	4 042	6 391	8 553	10 528	12 318
4 800	986	4 125	6 521	8 727	10 743	12 569

75/65/20 °C → 75 °C inlet temperature, 65 °C outlet temp., 20 °C room temp. / Output 90/70/20 °C = ~ 1,22 x 75/65/20 °C / Output 70/55/20 °C = ~ 0,84 x 75/65/20 °C / Heating outputs in accordance with EN 16430 / Not listed heating outputs for lengths per 100 mm steps calculate linearly. Exact values can be found at www.isan.cz

Acoustic power [dB(A)]

Length L [mm]	Speed [-] / Acoustic power [dB(A)]					
	0 V	2 V	4 V	6 V	8 V	10 V
700	-	< 25	26	30	36	43
800	-	< 25	26	30	37	44
900	-	< 25	27	32	38	45
1 000	-	< 25	27	32	38	45
1 100	-	< 25	27	33	39	46
1 200	-	< 25	28	33	40	47
1 300	-	< 25	28	34	40	47
1 400	-	< 25	29	34	41	48
1 500	-	< 25	29	34	41	48
1 600	-	< 25	29	35	41	48
1 700	-	< 25	30	35	42	49
1 800	-	< 25	30	36	42	49
1 900	-	< 25	30	36	43	50
2 000	-	< 25	30	36	43	50
2 100	-	< 25	31	37	43	50
2 200	-	< 25	31	37	44	51
2 300	-	< 25	31	37	44	51
2 400	-	< 25	31	38	44	51
2 500	-	< 25	31	38	45	51
2 600	-	< 25	31	38	45	52
2 700	-	< 25	32	38	45	52
2 800	-	< 25	32	39	45	52
2 900	-	< 25	32	39	46	52
3 000	-	25	32	39	46	53
3 200	-	25	32	39	46	53
3 400	-	25	33	40	47	53
3 600	-	25	33	40	47	54
3 800	-	25	33	41	47	54
4 000	-	26	34	41	48	54
4 200	-	26	34	41	48	55
4 400	-	26	34	42	48	55
4 600	-	26	34	42	49	55
4 800	-	26	34	42	49	56

Q[W] 55/45/20 °C (ΔT=30 °C)

Length L [mm]	Speed [-] / Heating output [W]					
	0 V	2 V	4 V	6 V	8 V	10 V
700	43	176	278	372	458	536
800	53	235	371	497	611	715
900	64	282	445	596	734	858
1 000	75	399	631	844	1 039	1 215
1 100	85	399	631	844	1 039	1 215
1 200	96	469	742	993	1 222	1 430
1 300	107	517	816	1 092	1 345	1 574
1 400	117	575	909	1 217	1 498	1 752
1 500	128	633	1 002	1 341	1 650	1 931
1 600	138	690	1 091	1 460	1 797	2 103
1 700	149	690	1 091	1 460	1 797	2 103
1 800	159	798	1 262	1 688	2 078	2 432
1 900	170	866	1 369	1 832	2 255	2 639
2 000	181	925	1 462	1 956	2 408	2 818
2 100	191	971	1 536	2 056	2 531	2 961
2 200	202	971	1 536	2 056	2 531	2 961
2 300	213	1 089	1 722	2 304	2 836	3 318
2 400	223	1 089	1 722	2 304	2 836	3 318
2 500	233	1 160	1 833	2 453	3 019	3 532
2 600	244	1 206	1 907	2 552	3 142	3 676
2 700	255	1 253	1 981	2 652	3 264	3 819
2 800	265	1 324	2 092	2 800	3 448	4 034
2 900	276	1 380	2 182	2 920	3 594	4 205
3 000	287	1 380	2 182	2 920	3 594	4 205
3 200	308	1 556	2 460	3 292	4 052	4 741
3 400	329	1 615	2 552	3 416	4 205	4 920
3 600	350	1 779	2 812	3 764	4 633	5 421
3 800	371	1 837	2 905	3 888	4 786	5 600
4 000	393	1 943	3 072	4 111	5 061	5 921
4 200	413	2 070	3 272	4 380	5 391	6 307
4 400	435	2 178	3 443	4 608	5 672	6 636
4 600	456	2 304	3 644	4 876	6 002	7 023
4 800	477	2 352	3 718	4 975	6 125	7 166

Fans input power [W]*

Length L [mm]	Number of fans	Speed [-] / Fans input power [W]*				
		2 V	4 V	6 V	8 V	10 V
700	1	1	1	2	2	3
800	1	1	1	2	3	4
900	1	1	2	2	3	5
1 000	1	1	2	3	4	6
1 100	1	1	2	3	4	6
1 200	2	2	2	4	5	8
1 300	2	2	3	4	6	9
1 400	2	2	3	4	6	9
1 500	2	2	3	4	7	10
1 600	1	1	2	3	6	10
1 700	2	2	3	4	7	11
1 800	2	2	3	5	8	12
1 900	2	2	3	4	7	12
2 000	2	2	3	5	8	13
2 100	2	2	3	5	8	14
2 200	2	2	3	5	8	14
2 300	2	2	3	5	9	16
2 400	2	2	3	5	9	16
2 500	3	3	4	6	10	17
2 600	3	3	4	6	11	18
2 700	3	3	4	6	11	19
2 800	3	3	4	7	12	19
2 900	2	2	3	5	11	19
3 000	3	3	4	7	12	20
3 200	3	3	4	6	12	22
3 400	3	3	4	7	13	23
3 600	3	3	5	7	14	25
3 800	4	4	6	8	15	26
4 000	4	4	6	9	16	28
4 200	3	3	5	8	16	28
4 400	4	4	6	10	18	31
4 600	4	4	6	9	18	32
4 800	4	4	6	9	18	33

* Approximate fan input powers / When using electrothermal actuator add in the trench heater's power 3 W

FRT 0140 0300

TRENCH HEATER WITH FAN



- > Flats, detached houses, offices, administrative buildings
- > Suitable for low-temperature systems
- > High heating output
- > Continuous speed control
- > Quiet operation
- > Common electricity consumption **2 W/m**
- > Using in dry environment

Technical data

Trench heater

Height [H]	140 mm
Width [W]	300 mm
Length [L]	700-4800 mm in step 100 mm

Heat exchanger

Type	Al-Cu lamellar
Length	L-295 mm
Connection thread	2xG1/2" inner

Working conditions

Max. temperature	110 °C
Max. overpressure	1 MPa (10 bar)
Protection	IP 20
Ambient conditions	Temp. T = +2 to +40 °C Humidity Rh = 20 to 70%

Trench heater standard equipment

Trough	Galvanized steel trough with surface finish and black spray layer inside, black cover plates of connection
Heat exchanger	Al-Cu lamellar exchanger with air vent valve, black painted
Grille	Design walkable grille according the customer's choice (stainless grilles surcharge)
Ledge	Made of anodized aluminium, type and colour according the customer's choice
Fan	Modern tangential fan with 24 V DC EC motor with high efficiency, rotors protection
Assembly elements	Leveling screws for setting up the trough, mounting brackets
Manual	Manual for the progress of work during installation and user manual
Wiring	Electrical wiring diagram of the trench heaters
Mounting board	Cover and the spacer particle board for easy installation
Package	Transport package for protection against damage during transportation and handling

Technical drawing

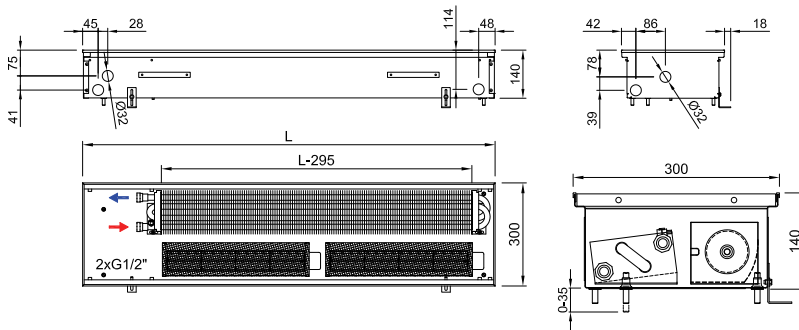

Connection to heating system

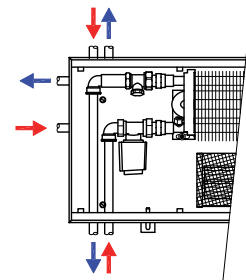

Accessories per order



Variants

Grilles

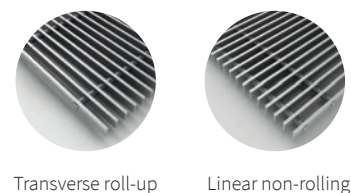

Peripheral ledge



① Grilles → 6 ② Ledges → 8 ③ Acoustic power → 13 ④ Accessories → 14 ⑤ Hydraulic parameters → 126 ⑥ Wiring → 129

Code example: FRT 0140 0300 2700 C 32 J3 R - 5

Trench heater **FRT** H = 140 mm, W = 300 mm, L = 2 700 mm, „**C**“ Galvanized steel trough with black inside, heat exchanger and inner parts painted black, „**32**“ black anodized aluminium grille, linear, rigid, „**J3**“ peripheral ledge „**J**“, black anodized aluminium „**R**“ water connection at the right side (when installing the heat exchanger closer to the window, fans to the room), „**5**“ 24 V DC fans without controller (controller is not needed)



Trench heater heating output FRT 0140 0300

Q[W] 75/65/20 °C (ΔT=50 °C)

Temperature exponent 1,1

Length L [mm]	Speed [-] / Heating output [W]					
	0 V	2 V	4 V	6 V	8 V	10 V
700	129	452	692	896	1 065	1 198
800	161	605	925	1 198	1 423	1 602
900	193	757	1 158	1 499	1 782	2 005
1 000	225	990	1 514	1 961	2 330	2 622
1 100	256	990	1 514	1 961	2 330	2 622
1 200	288	1 210	1 850	2 395	2 846	3 203
1 300	320	1 362	2 082	2 697	3 205	3 607
1 400	352	1 443	2 206	2 857	3 395	3 820
1 500	384	1 595	2 439	3 158	3 753	4 224
1 600	416	1 758	2 688	3 481	4 137	4 656
1 700	447	1 758	2 688	3 481	4 137	4 656
1 800	479	1 981	3 028	3 921	4 660	5 245
1 900	511	2 211	3 380	4 377	5 202	5 854
2 000	543	2 363	3 613	4 679	5 560	6 257
2 100	575	2 515	3 846	4 980	5 918	6 661
2 200	607	2 515	3 846	4 980	5 918	6 661
2 300	639	2 748	4 202	5 442	6 467	7 278
2 400	670	2 748	4 202	5 442	6 467	7 278
2 500	702	2 968	4 538	5 876	6 983	7 859
2 600	734	3 120	4 771	6 178	7 342	8 262
2 700	766	3 273	5 004	6 479	7 700	8 666
2 800	798	3 353	5 127	6 639	7 890	8 880
2 900	830	3 516	5 376	6 962	8 274	9 311
3 000	861	3 516	5 376	6 962	8 274	9 311
3 200	925	3 969	6 068	7 858	9 338	10 509
3 400	989	4 121	6 301	8 160	9 697	10 913
3 600	1 053	4 507	6 890	8 923	10 604	11 934
3 800	1 116	4 726	7 226	9 357	11 120	12 514
4 000	1 180	5 031	7 692	9 960	11 837	13 321
4 200	1 244	5 274	8 064	10 443	12 411	13 967
4 400	1 307	5 497	8 404	10 883	12 934	14 556
4 600	1 371	5 879	8 989	11 641	13 834	15 568
4 800	1 435	6 032	9 222	11 942	14 192	15 972

75/65/20 °C → 75 °C inlet temperature, 65 °C outlet temp., 20 °C room temp. / Output 90/70/20 °C = ~ 1,22 x 75/65/20 °C / Output 70/55/20 °C = ~ 0,84 x 75/65/20 °C. / Heating outputs in accordance with EN 16430 / Not listed heating outputs for lengths per 100 mm steps calculate linearly. Exact values can be found at www.isan.cz

Acoustic power [dB(A)]

Length L [mm]	Speed [-] / Acoustic power [dB(A)]					
	0 V	2 V	4 V	6 V	8 V	10 V
700	-	< 25	35	43	51	57
800	-	< 25	35	44	51	57
900	-	26	36	44	52	58
1 000	-	26	36	45	52	58
1 100	-	27	37	45	52	58
1 200	-	27	37	45	53	59
1 300	-	28	37	46	53	59
1 400	-	28	38	46	53	59
1 500	-	29	38	46	54	60
1 600	-	29	38	47	54	60
1 700	-	29	38	47	54	60
1 800	-	29	38	47	54	60
1 900	-	30	39	47	55	61
2 000	-	30	39	47	55	61
2 100	-	30	39	48	55	61
2 200	-	31	40	48	55	61
2 300	-	31	40	48	55	61
2 400	-	31	40	48	55	62
2 500	-	31	40	48	56	62
2 600	-	31	40	48	56	62
2 700	-	32	40	48	56	62
2 800	-	32	41	49	56	62
2 900	-	32	41	49	56	62
3 000	-	32	41	49	56	62
3 200	-	32	41	49	57	63
3 400	-	33	41	49	57	63
3 600	-	33	42	50	57	63
3 800	-	33	42	50	57	63
4 000	-	34	42	50	57	64
4 200	-	34	42	50	57	64
4 400	-	34	42	50	57	64
4 600	-	34	43	51	58	64
4 800	-	35	43	51	58	64

Q[W] 55/45/20 °C (ΔT=30 °C)

Length L [mm]	Speed [-] / Heating output [W]					
	0 V	2 V	4 V	6 V	8 V	10 V
700	62	258	395	511	607	683
800	78	345	527	683	811	913
900	93	432	660	855	1 016	1 143
1 000	109	564	863	1 118	1 328	1 495
1 100	124	564	863	1 118	1 328	1 495
1 200	139	690	1 055	1 365	1 623	1 826
1 300	155	777	1 187	1 538	1 827	2 056
1 400	170	823	1 258	1 629	1 936	2 178
1 500	186	909	1 391	1 800	2 140	2 408
1 600	201	1 002	1 532	1 985	2 359	2 654
1 700	216	1 002	1 532	1 985	2 359	2 654
1 800	232	1 129	1 726	2 235	2 657	2 990
1 900	247	1 261	1 927	2 495	2 966	3 337
2 000	263	1 347	2 060	2 668	3 170	3 567
2 100	278	1 434	2 193	2 839	3 374	3 798
2 200	294	1 434	2 193	2 839	3 374	3 798
2 300	309	1 567	2 396	3 103	3 687	4 149
2 400	324	1 567	2 396	3 103	3 687	4 149
2 500	340	1 692	2 587	3 350	3 981	4 481
2 600	355	1 779	2 720	3 522	4 186	4 710
2 700	371	1 866	2 853	3 694	4 390	4 941
2 800	386	1 912	2 923	3 785	4 498	5 063
2 900	402	2 005	3 065	3 969	4 717	5 308
3 000	417	2 005	3 065	3 969	4 717	5 308
3 200	448	2 263	3 459	4 480	5 324	5 991
3 400	479	2 349	3 592	4 652	5 528	6 222
3 600	510	2 570	3 928	5 087	6 046	6 804
3 800	540	2 694	4 120	5 335	6 340	7 134
4 000	571	2 868	4 385	5 678	6 749	7 595
4 200	602	3 007	4 597	5 954	7 076	7 963
4 400	633	3 134	4 791	6 205	7 374	8 299
4 600	664	3 352	5 125	6 637	7 887	8 876
4 800	695	3 439	5 258	6 808	8 091	9 106

Fans input power [W]*

Length L [mm]	Number of fans	Speed [-] / Fans input power [W]*				
		2 V	4 V	6 V	8 V	10 V
700	1	1	2	3	1	7
800	1	1	2	3	6	9
900	1	1	2	5	8	12
1 000	1	1	3	6	14	18
1 100	1	1	3	6	14	18
1 200	2	2	4	6	12	17
1 300	2	2	4	8	14	21
1 400	2	2	5	8	14	25
1 500	2	2	5	8	20	27
1 600	1	2	5	10	19	26
1 700	2	2	5	10	21	30
1 800	2	2	6	11	27	36
1 900	2	3	6	13	19	32
2 000	2	3	6	13	25	34
2 100	2	3	7	15	26	37
2 200	2	3	7	15	26	37
2 300	2	3	7	15	32	44
2 400	2	3	7	15	32	44
2 500	3	4	8	16	31	43
2 600	3	4	8	18	32	46
2 700	3	4	9	19	33	49
2 800	3	4	9	18	38	52
2 900	2	4	9	20	37	51
3 000	3	4	9	20	39	55
3 200	3	5	11	23	37	58
3 400	3	5	11	23	43	60
3 600	3	5	12	25	50	69
3 800	4	6	12	27	45	69
4 000	4	6	13	29	51	74
4 200	3	6	13	30	55	77
4 400	4	6	14	30	63	87
4 600	4	7	15	33	61	85
4 800	4	7	15	34	62	88

* Approximate fan input powers / When using electrothermal actuator add in the trench heater's power 3 W

FRT 0140 0425

TRENCH HEATER WITH FAN



- › Flats, detached houses, offices, administrative buildings
- › Suitable for low-temperature systems
- › High heating output
- › Continuous speed control
- › Quiet operation
- › Common electricity consumption **2 W/m**
- › Using in dry environment

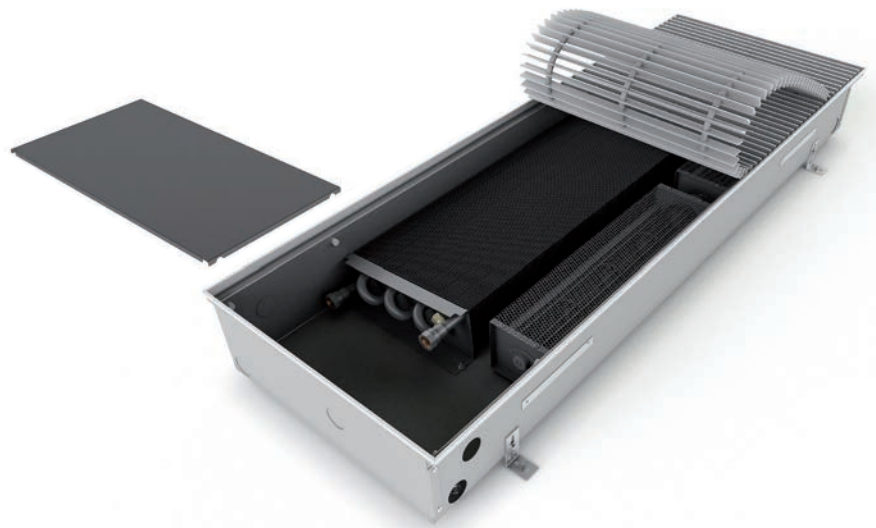

Technical data

Trench heater

Height [H]	140 mm
Width [W]	425 mm
Length [L]	700-4 800 mm in step 100 mm

Heat exchanger

Type	Al-Cu lamellar
Length	L-295 mm
Connection thread	2xG1/2" inner

Working conditions

Max. temperature	110 °C
Max. overpressure	1 MPa (10 bar)
Protection	IP 20
Ambient conditions	Temp. T = +2 to +40 °C Humidity Rh = 20 to 70%

Trench heater standard equipment

Trough	Galvanized steel trough with surface finish and black spray layer inside, black cover plates of connection
Heat exchanger	Al-Cu lamellar exchanger with air vent valve, black painted
Grille	Design walkable grille according the customer's choice (stainless grilles surcharge)
Ledge	Made of anodized aluminium, type and colour according the customer's choice
Fan	Modern tangential fan with 24 V DC EC motor with high efficiency, rotors protection
Assembly elements	Leveling screws for setting up the trough, mounting brackets
Manual	Manual for the progress of work during installation and user manual
Wiring	Electrical wiring diagram of the trench heaters
Mounting board	Cover and the spacer particle board for easy installation
Package	Transport package for protection against damage during transportation and handling

Technical drawing

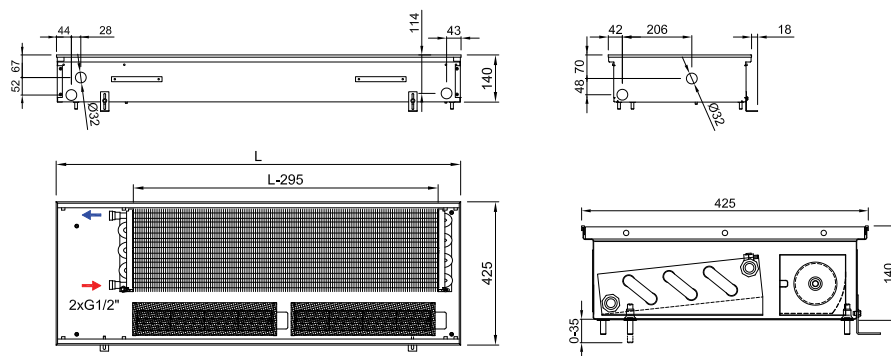

Connection to heating system

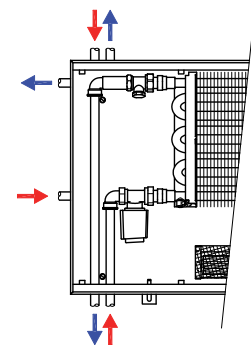

Accessories per order



Variants

Grilles

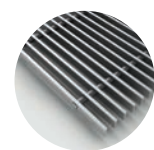

Transverse roll-up

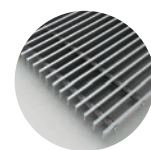

Linear non-rolling

Peripheral ledge

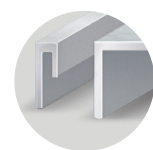

① Grilles → 6 ② Ledges → 8 ③ Acoustic power → 13 ④ Accessories → 14 ⑤ Hydraulic parameters → 126 ⑥ Wiring → 129

Code example: FRT 0140 0425 4400 C 64 L2 L - 5

Trench heater FRT H=140 mm, W= 425 mm, L= 4 400 mm, „C“ Galvanized steel trough with black inside, heat exchanger and inner parts painted black, „64“ stained oak grille, transverse, roll-up, „L2“ peripheral ledge, „L“ with an overlap, bronze anodized aluminium, „L“ water connection at the left side (when installing the heat exchanger closer to the window, fans to the room), „5“ 24 V DC fans without controller (controller is not needed)



Trench heater heating output FRT 0140 0425

Q[W] 75/65/20 °C (ΔT=50 °C)

Temperature exponent 1,1

Length L [mm]	Speed [-] / Heating output [W]					
	0 V	2 V	4 V	6 V	8 V	10 V
700	216	756	1 050	1 310	1 536	1 727
800	269	1 010	1 404	1 751	2 053	2 308
900	322	1 264	1 757	2 192	2 570	2 889
1 000	375	1 654	2 298	2 867	3 361	3 779
1 100	429	1 654	2 298	2 867	3 361	3 779
1 200	482	2 020	2 807	3 503	4 105	4 616
1 300	535	2 274	3 161	3 944	4 622	5 197
1 400	588	2 409	3 348	4 178	4 896	5 505
1 500	642	2 664	3 702	4 619	5 413	6 086
1 600	695	2 936	4 080	5 091	5 967	6 708
1 700	748	2 936	4 080	5 091	5 967	6 708
1 800	801	3 307	4 597	5 735	6 722	7 557
1 900	855	3 691	5 131	6 401	7 502	8 435
2 000	908	3 946	5 484	6 842	8 019	9 016
2 100	961	4 200	5 838	7 283	8 536	9 597
2 200	1 015	4 200	5 838	7 283	8 536	9 597
2 300	1 068	4 589	6 379	7 958	9 327	10 487
2 400	1 121	4 589	6 379	7 958	9 327	10 487
2 500	1 174	4 956	6 888	8 593	10 072	11 324
2 600	1 228	5 210	7 241	9 034	10 589	11 905
2 700	1 281	5 464	7 595	9 476	11 106	12 487
2 800	1 334	5 599	7 782	9 709	11 380	12 795
2 900	1 387	5 872	8 161	10 181	11 933	13 417
3 000	1 441	5 872	8 161	10 181	11 933	13 417
3 200	1 547	6 627	9 211	11 492	13 469	15 143
3 400	1 654	6 881	9 565	11 933	13 986	15 725
3 600	1 760	7 525	10 459	13 049	15 294	17 195
3 800	1 867	7 891	10 968	13 684	16 039	18 032
4 000	1 973	8 400	11 675	14 566	17 073	19 195
4 200	2 080	8 807	12 241	15 272	17 900	20 125
4 400	2 186	9 179	12 757	15 916	18 655	20 974
4 600	2 293	9 817	13 645	17 023	19 953	22 433
4 800	2 399	10 072	13 998	17 465	20 470	23 014

75/65/20 °C → 75 °C inlet temperature, 65 °C outlet temp., 20 °C room temp. / Output 90/70/20 °C = ~ 1,22 x 75/65/20 °C / Output 70/55/20 °C = ~ 0,84 x 75/65/20 °C / Heating outputs in accordance with EN 16430 / Not listed heating outputs for lengths per 100 mm steps calculate linearly. Exact values can be found at www.isan.cz

Acoustic power [dB(A)]

Length L [mm]	Speed [-] / Acoustic power [dB(A)]					
	0 V	2 V	4 V	6 V	8 V	10 V
700	-	<25	35	45	52	58
800	-	26	36	45	53	59
900	-	27	37	46	53	59
1 000	-	27	37	46	54	60
1 100	-	28	38	46	54	60
1 200	-	28	38	47	54	61
1 300	-	29	39	47	55	61
1 400	-	29	39	48	55	61
1 500	-	29	39	48	55	62
1 600	-	30	39	48	55	62
1 700	-	30	40	48	56	62
1 800	-	30	40	49	56	62
1 900	-	31	40	49	56	62
2 000	-	31	40	49	56	63
2 100	-	31	40	49	56	63
2 200	-	31	41	49	57	63
2 300	-	32	41	50	57	63
2 400	-	32	41	50	57	63
2 500	-	32	41	50	57	64
2 600	-	32	41	50	57	64
2 700	-	33	41	50	57	64
2 800	-	33	42	50	58	64
2 900	-	33	42	50	58	64
3 000	-	33	42	51	58	64
3 200	-	33	42	51	58	65
3 400	-	34	42	51	58	65
3 600	-	34	43	51	58	65
3 800	-	34	43	51	59	65
4 000	-	35	44	52	59	65
4 200	-	35	44	52	59	66
4 400	-	35	44	52	59	66
4 600	-	35	44	52	59	66
4 800	-	36	44	52	59	66

Q[W] 55/45/20 °C (ΔT=30 °C)

Length L [mm]	Speed [-] / Heating output [W]					
	0 V	2 V	4 V	6 V	8 V	10 V
700	105	431	599	747	876	985
800	130	576	800	998	1 170	1 316
900	156	721	1 002	1 250	1 465	1 647
1 000	182	943	1 310	1 635	1 916	2 154
1 100	208	943	1 310	1 635	1 916	2 154
1 200	233	1 152	1 600	1 997	2 340	2 632
1 300	259	1 296	1 802	2 249	2 635	2 963
1 400	285	1 373	1 909	2 382	2 791	3 139
1 500	311	1 519	2 111	2 633	3 086	3 470
1 600	336	1 674	2 326	2 902	3 402	3 824
1 700	362	1 674	2 326	2 902	3 402	3 824
1 800	388	1 885	2 621	3 270	3 832	4 308
1 900	414	2 104	2 925	3 649	4 277	4 809
2 000	440	2 250	3 127	3 901	4 572	5 140
2 100	465	2 395	3 328	4 152	4 867	5 471
2 200	491	2 395	3 328	4 152	4 867	5 471
2 300	517	2 616	3 637	4 537	5 318	5 979
2 400	543	2 616	3 637	4 537	5 318	5 979
2 500	568	2 826	3 927	4 899	5 742	6 456
2 600	595	2 970	4 128	5 150	6 037	6 787
2 700	620	3 115	4 330	5 402	6 332	7 119
2 800	646	3 192	4 437	5 535	6 488	7 295
2 900	672	3 348	4 653	5 804	6 803	7 649
3 000	698	3 348	4 653	5 804	6 803	7 649
3 200	749	3 778	5 251	6 552	7 679	8 633
3 400	801	3 923	5 453	6 803	7 974	8 965
3 600	852	4 290	5 963	7 439	8 719	9 803
3 800	904	4 499	6 253	7 802	9 144	10 280
4 000	955	4 789	6 656	8 304	9 734	10 943
4 200	1 007	5 021	6 979	8 707	10 205	11 474
4 400	1 058	5 233	7 273	9 074	10 636	11 958
4 600	1 110	5 597	7 779	9 705	11 376	12 790
4 800	1 161	5 742	7 981	9 957	11 670	13 121

Fans input power [W]*

Length L [mm]	Number of fans	Speed [-] / Fans input power [W]*				
		2 V	4 V	6 V	8 V	10 V
700	1	1	2	3	1	7
800	1	1	2	3	6	9
900	1	1	2	5	8	12
1 000	1	1	3	6	14	18
1 100	1	1	3	6	14	18
1 200	2	2	4	6	12	17
1 300	2	2	4	8	14	21
1 400	2	2	5	8	14	25
1 500	2	2	5	8	20	27
1 600	1	2	5	10	19	26
1 700	2	2	5	10	21	30
1 800	2	2	6	11	27	36
1 900	2	3	6	13	19	32
2 000	2	3	6	13	25	34
2 100	2	3	7	15	26	37
2 200	2	3	7	15	26	37
2 300	2	3	7	15	32	44
2 400	2	3	7	15	32	44
2 500	3	4	8	16	31	43
2 600	3	4	8	18	32	46
2 700	3	4	9	19	33	49
2 800	3	4	9	18	38	52
2 900	2	4	9	20	37	51
3 000	3	4	9	20	39	55
3 200	3	5	11	23	37	58
3 400	3	5	11	23	43	60
3 600	3	5	12	25	50	69
3 800	4	6	12	27	45	69
4 000	4	6	13	29	51	74
4 200	3	6	13	30	55	77
4 400	4	6	14	30	63	87
4 600	4	7	15	33	61	85
4 800	4	7	15	34	62	88

* Approximate fan input powers / When using electrothermal actuator add in the trench heater's power 3 W

FRC

FRD





Fan-assisted trench heaters
**with lamellar heat exchanger,
heating and cooling**

TERMO FRC, FRD

Fan-assisted heaters for heating and cooling



Benefits

- › High heating /cooling output
- › Energy saving 24 V DC fans
- › Continuous speed control 0 ... 10 V DC
- › Condensate pump may be added

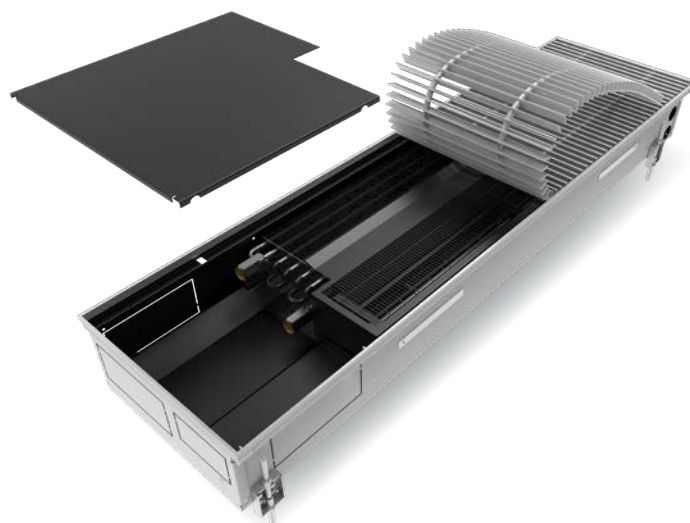

Trench heaters with forced convection via a fan provide a high heating/cooling output. They are a suitable addition to cooling and air-conditioning units, the effect of which does not reach up to the windows. The optimal control of the forced convection is provided by fans with continuous speed control and low energy consumption. Spaces with thermal losses in winter and high thermal gains in summer are effectively regulated from the floor, without disturbing the aesthetics of the room with large-area glazing. The heaters are fitted with an Al-Cu lamellar exchanger through which the heating/cooling medium flows. Tangential fans are placed in front of the exchanger along the whole length, ensuring uniform coverage of the heat exchanger and, subsequently, optimal distribution of temperature within the room. The FRC trench heater 135 × 325 is supplied for both 2-pipe and 4-pipe systems.

The fans are fitted with efficient electrically commuted (EC) motors functioning on the basis of a safe voltage of 24 V DC. The motors have a very low consumption of electric power. The fan speed is controlled continuously with a controlling voltage of 0...10 V DC.

The room thermostat or a higher BMS secures the correct function of all installed FRC trench heaters, compares the set and actual temperature in the room, opens the flowing of the heating/cooling medium in the heat exchanger and controls the fan revolutions according to the difference in the temperatures and the set mode of operation.

The use of new technologies secures optimal heating of the interior, energy savings, high efficiency and flexibility of heating. The trench heater is powered with safe voltage only, all components are powered with 24 V DC.

Trench heaters may be installed with a pump for condensate which is generated in the cooling mode of operation at low temperature of the intake water and high air humidity. The pump is powered with 230 V AC.

FRC, 2 pipe, single-circuit

AVAILABLE MODELS

- › FRC 100 × 175 mm
- › FRC 135 × 325 mm

2 pipe trench heaters are connected to a single piping circuit. In this case, the heating system contains either a heating or cooling medium. Switching between the heating mode (connection to the source of heat) and the cooling mode (connection to the source of cooling) is usually performed in a technical room.

FRD, 4 pipe, double-circuit

AVAILABLE MODELS

- › FRD 135 × 325 mm

4 pipe trench heaters are connected to two separate piping circuits. Both the heating and cooling media are available at the same time. The heater starts heating or cooling upon evaluation of the ambient conditions. Changes may occur at any time during the day.

Heaters with integrated power supply

In summer months, heating/cooling trench heaters are usually operated at full power. With a higher number of heaters installed in a single room, the capacity of a switching source placed in the switchboard may be soon used up. In such cases, it is beneficial to use heaters with their own sources and connect them in an unlimited number and regardless of the connection length. Such heaters are marked FZC and FZD; for details of this option see page 96.

FRC, FRD overview of heaters with fan, heating/cooling

2 PIPE

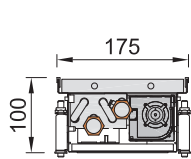

FRC 0100 0175
page 86

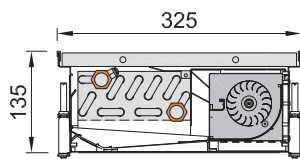

FRC 0135 0325
page 88

4 PIPE

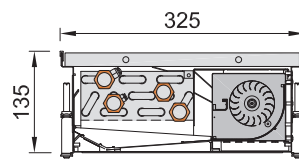

FRD 0135 0325
page 90

Placement in the floor

The trench heaters are laid in the floor so that the heat exchanger is closer to the window side, while fans are placed deeper into the room. The vertical and horizontal distribution of temperatures in the heated room is uniform and conditions are created to provide thermal comfort. Air flow is comparable to the heat transfer with classical heating bodies placed on the wall below windows. When cooling is on, the air is circulated in the space around the windows, creating a pleasant climate in places not reached by air-conditioning or ceiling cooling.

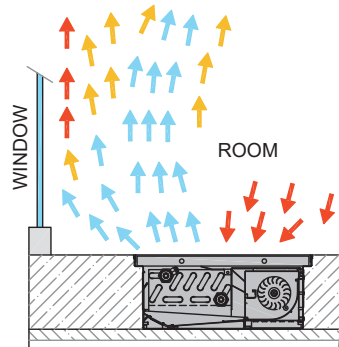
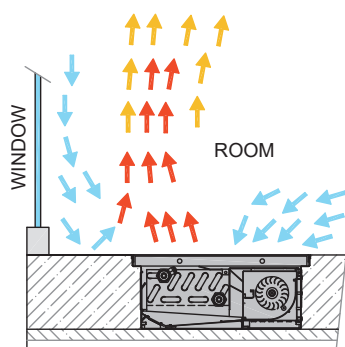

Heating

- > Air becomes heated by flowing through the heat exchanger
- > Warm air is mixed with cool air running down the window surfaces
- > Air circulation:
 - Heating air in the room
 - Screening out window surfaces
 - Secondarily demisting window surfaces

Cooling

- > Air becomes cooled by flowing through the heat exchanger
- > Cool air is mixed with warm air rising along the window surfaces
- > Air circulation:
 - Cooling down air around the window surfaces
 - Reducing radiation of the window surfaces
 - Condensate is formed with water of low temperature, which is removed from heater
 - Local cooling only; completes but does not replace a cooling or air-conditioning system not reaching the window surfaces

Condensate and condensate pump

During the heater operation in cooling mode in summer, air humidity condenses on the heater ledges. Droplets of water are formed and trickle down into a condensate tub located under the heater. The condensate is removed from the tub through a small tube which must be connected to a drainage hose or a condensate pump must be installed.



Intake air filter

Heaters with 135 × 325 mm dimensions may be fitted with a filter placed on the protective grille above the fan. It prevents larger pieces of dirt from passing into the heater space. The filter decreases the trench heater output at maximum revolutions by approximately 12%.



FRC 0100 0175

FAN-ASSISTED TRENCH HEATER FOR HEATING/COOLING, 2 PIPE



- > Fully glazed rooms with big heat gains
- > Flats, villas, residences, hotels
- > High heat output
- > Optimum after-cooling output
- > Convection with tangential fans
- > Dry environment
- > Safety voltage 24 V



Technical data

Trench heater

Height [H]	100 mm
Width [W]	175 mm
Length [L]	800-2800 mm in step 400 mm

Heat exchanger

Type	Al-Cu lamellar
Length	L-430 mm
Connection thread	2xG1/2" inner

Working conditions

Max. temperature	110 °C
Max. overpressure	1 MPa (10 bar)
Protection	IP 20
Ambient conditions	Temp. T = +2 to +40 °C Humidity Rh = 20 to 70%

Trench heater standard equipment

Trough	Galvanized steel trough with surface finish and black spray layer inside, black cover plates of connection, inner condensate trough from stainless steel
Heat exchanger	Al-Cu lamellar exchanger with air vent valve, black painted
Grille	Design walkable grille according to the customer's choice
Ledge	Made of anodized aluminium, type and colour according to the customer's choice
Fan	Modern tangential fan with 24 V DC EC motor with high efficiency, rotors protection
Assembly elements	Leveling screws for setting up the trough, mounting brackets
Manual	Manual for the progress of work during installation and user manual
Wiring	Electrical wiring diagram of the trench heaters
Mounting board	Cover and the spacer particle board for easy installation
Package	Transport package for protection against damage during transportation and handling

Technical drawing

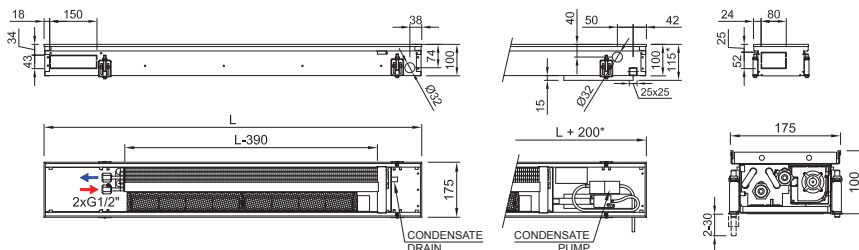

* dimension if condensate pump is used

Warning: When a **condensate pump** is used, the trench heater is **200 mm longer**. If a pump is required, this should be stated in the order. **Lengths:** 1 000; 1 400; 1 800; 2 200; 2 600 and 3 000 mm.

Connection to heating system

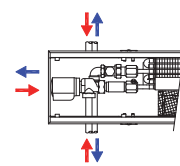

Accessories per order



Variants

Grilles

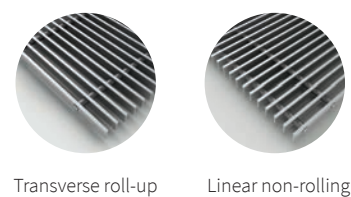

Peripheral ledge

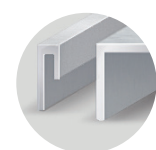

- ① Grilles → 6
- ② Ledges → 8
- ③ Acoustic power → 13
- ④ Accessories → 14
- ⑤ Hydraulic parameters → 126

Code example: FRC 0100 0175 1600 C 12 J1 L - 5

Trench heater **FRC** H = 100 mm, W = 175 mm, L = 1 600 mm, „C“ Galvanized steel trough with black inside, heat exchanger and inner parts painted black, „12“ natur anodized aluminium grille, linear, rigid, „J1“ peripheral ledge „J“, natur anodized aluminium, „L“ water connection at the left side (when installing the heat exchanger closer to the window, fans to the room), „5“ 24 V DC fans without controller (controller is not needed)



Trench heater heating output FRC 0100 0175, 2 pipe

Q[W] 75/65/20 °C (ΔT=50 °C)

Temperature exponent 1,0

Length L [mm]	Speed [-] / Heating output [W]						
	0V	1V	2V	4V	6V	8V	10V
800	23	104	240	479	673	822	926
1200	45	235	545	1 087	1 526	1 863	2 104
1600	67	339	785	1 566	2 199	2 685	3 024
2000	89	471	1 089	2 173	3 052	3 727	4 197
2400	112	575	1 330	2 652	3 725	4 549	5 122
2800	134	706	1 634	3 260	4 578	5 590	6 295

Length L [mm]	Speed [-] / Heating output [W]						
	0V	1V	2V	4V	6V	8V	10V
800	11	62	144	288	404	493	555
1200	22	141	327	652	916	1 118	1 262
1600	33	204	471	939	1 320	1 611	1 814
2000	43	283	654	1 304	1 831	2 236	2 518
2400	54	345	798	1 591	2 235	2 729	3 073
2800	65	424	980	1 956	2 747	3 354	3 777

75/65/20 °C → 75 °C inlet temperature, 65 °C outlet temp., 20 °C room temp. / Output 90/70/20 °C ≈ 1,22 x 75/65/20 °C / Output 70/55/20 °C ≈ 0,84 x 75/65/20 °C / Heating outputs in accordance with EN 16430



Trench heater cooling output FRC 0100 0175, 2 pipe

17/19/28 °C (ΔT=10 °C)

Temperature exponent 0,9

Length L [mm]	Speed [-] / Cooling output [W]						
	0V	1V	2V	4V	6V	8V	10V
800	-	10	23	59	90	117	140
1200	-	22	51	130	199	259	310
1600	-	31	74	187	287	374	447
2000	-	43	103	260	399	519	620
2400	-	53	125	317	487	633	757
2800	-	65	154	390	598	778	931

Cooling outputs in accordance with EN 16430



Acoustic power [dB(A)]

Length L [mm]	Speed [-] / Acoustic power [dB(A)]						
	0V	1V	2V	4V	6V	8V	10V
800	-	< 25	< 25	32	39	48	54
1200	-	< 25	26	34	41	50	56
1600	-	26	30	37	42	51	57
2000	-	27	31	38	43	52	58
2400	-	31	32	38	44	52	59
2800	-	31	33	39	44	53	59

More details on page → 13



Fans input power [W]*

Length L [mm]	Number of fans	Speed [-] / Fans input power [W]*					
		1V	2V	4V	6V	8V	10V
800	1	1	1	2	3	5	8
1200	1	1	1	2	5	9	15
1600	2	1	2	4	7	13	22
2000	2	1	2	4	10	17	29
2400	3	2	3	6	12	21	36
2800	3	2	3	6	14	25	44

* Approximate fan input powers. / When using electrothermal actuator add in the trench heater's power 3 W

FRC 0135 0325

FAN-ASSISTED TRENCH HEATER FOR HEATING/COOLING, 2 PIPE



- > Fully glazed rooms with big heat gains
- > Flats, villas, residences, hotels
- > High heat output
- > Optimum after-cooling output
- > Convection with tangential fans
- > Dry environment
- > Safety voltage 24 V



Technical data

Trench heater

Height [H]	135 mm
Width [W]	325 mm
Length [L]	800-2800 mm in step 100 mm

Heat exchanger

Type	Al-Cu lamellar
Length	L-485 mm
Connection thread	2xG1/2" inner

Working conditions

Max. temperature	110 °C
Max. overpressure	1 MPa (10 bar)
Protection	IP 20
Ambient conditions	Temp. T = +2 to +40 °C Humidity Rh = 20 to 70%

Trench heater standard equipment

Trough	Galvanized steel trough with surface finish and black spray layer inside, black cover plates of connection, inner condensate trough from stainless steel
Heat exchanger	Al-Cu lamellar exchanger with air vent valve, black painted
Grille	Design walkable grille according the customer's choice*
Ledge	Made of anodized aluminium, type and colour according the customer's choice
Fan	Modern tangential fan with 24 V DC EC motor with high efficiency, rotors protection
Assembly elements	Leveling screws for setting up the trough, mounting brackets
Manual	Manual for the progress of work during installation and user manual
Wiring	Electrical wiring diagram of the trench heaters
Mounting board	Cover and the spacer particle board for easy installation
Package	Transport package for protection against damage during transportation and handling

Technical drawing

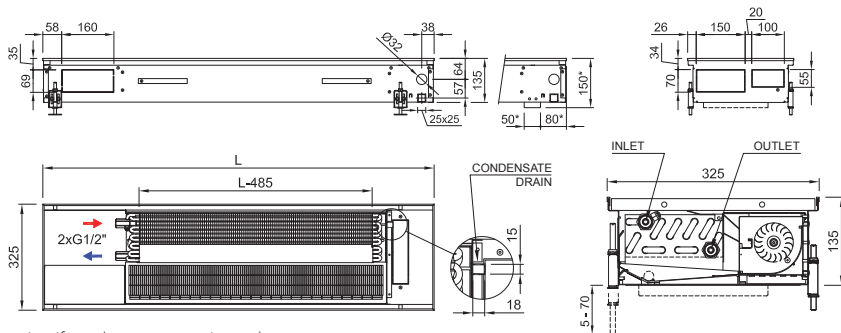

* dimension if condensate pump is used

Connection to heating system

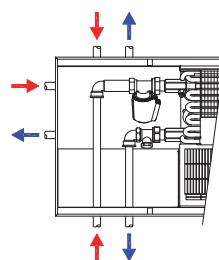

Accessories per order



Variants

Grilles

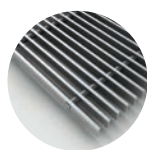

Transverse roll-up

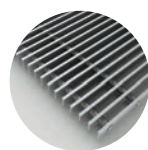

Linear non-rolling

Peripheral ledge



① Grilles → 6 ② Ledges → 8 ③ Acoustic power → 13 ④ Accessories → 14 ⑤ Hydraulic parameters → 126

Code example: FRC 0135 0325 2000 C 21 J2 L - 5

Trench heater FRC H = 135 mm, W = 325 mm, L = 2 000 mm, „C“ Galvanized steel trough with black inside, heat exchanger and inner parts painted black, „21“ bronze anodized aluminium grille, transverse, roll-up low, „J2“ peripheral ledge „J“, bronze anodized aluminium „L“ water connection at the left side (when installing the heat exchanger closer to the window, fans to the room), „5“ 24 V DC fans without controller (controller is not needed)



Trench heater heating output FRC 0135 0325, 2 pipe

Q[W] 75/65/20 °C (ΔT=50 °C)

Temperature exponent 1,0103

Length L [mm]	Speed [-] / Heating output [W]					
	0V	2V	4V	6V	8V	10V
800	154	668	1 114	1 463	1 741	1 964
900	203	880	1 468	1 927	2 294	2 588
1000	251	1 092	1 822	2 392	2 847	3 211
1100	300	1 304	2 175	2 856	3 400	3 835
1200	349	1 516	2 529	3 321	3 952	4 458
1300	398	1 728	2 883	3 785	4 505	5 082
1400	447	1 940	3 237	4 249	5 058	5 705
1500	495	2 152	3 590	4 714	5 611	6 329
1600	544	2 364	3 944	5 178	6 163	6 952
1700	593	2 576	4 298	5 643	6 716	7 576
1800	642	2 788	4 652	6 107	7 269	8 199
1900	691	3 000	5 005	6 571	7 822	8 823
2000	739	3 212	5 359	7 036	8 375	9 446
2100	788	3 424	5 713	7 500	8 927	10 070
2200	837	3 636	6 066	7 965	9 480	10 693
2300	886	3 848	6 420	8 429	10 033	11 317
2400	935	4 060	6 774	8 894	10 586	11 940
2500	984	4 272	7 128	9 358	11 138	12 564
2600	1 032	4 485	7 481	9 822	11 691	13 187
2700	1 081	4 697	7 835	10 287	12 244	13 811
2800	1 130	4 909	8 189	10 751	12 797	14 434

75/65/20 °C → 75 °C inlet temperature, 65 °C outlet temp., 20 °C room temp. / Output 90/70/20 °C = ~ 1,22 x 75/65/20 °C / Output 70/55/20 °C = ~ 0,84 x 75/65/20 °C / Heating outputs in accordance with EN 16430



Trench heater cooling output FRC 0135 0325, 2 pipe

17/19/28 °C (ΔT10)

Temperature exponent 0,9369

Length L [mm]	Speed [-] / Cooling output [W]				
	2V	4V	6V	8V	10V
800	88	158	221	280	336
900	115	208	291	369	442
1000	143	258	361	458	549
1100	171	308	431	547	655
1200	199	358	501	635	762
1300	227	408	572	724	868
1400	255	458	642	813	975
1500	282	508	712	902	1 081
1600	310	558	782	991	1 188
1700	338	608	852	1 080	1 294
1800	366	658	922	1 169	1 401
1900	394	708	992	1 257	1 507
2000	422	758	1 062	1 346	1 614
2100	449	808	1 133	1 435	1 720
2200	477	858	1 203	1 524	1 827
2300	505	908	1 273	1 613	1 933
2400	533	958	1 343	1 702	2 040
2500	561	1 008	1 413	1 791	2 146
2600	588	1 058	1 483	1 879	2 253
2700	616	1 108	1 553	1 968	2 359
2800	644	1 158	1 623	2 057	2 466

Cooling outputs in accordance with EN 16430



Fans input power [W]*

Length L [mm]	Number of fans	Speed [-] / Fans input power [W]*				
		2V	4V	6V	8V	10V
800	1	1	2	3	5	8
900	1	1	2	3	6	10
1 000	1	1	2	4	8	14
1 100	1	1	3	5	10	16
1 200	1	1	3	6	14	21
1 300	2	2	4	6	11	17
1 400	2	2	4	6	12	21
1 500	2	2	4	7	14	23
1 600	2	2	5	8	18	28
1 700	1	2	4	9	20	34
1 800	2	2	5	9	21	34

* Approximate fan input powers / When using electrothermal actuator add in the trench heater's power 3 W

55/45/20 °C (ΔT30)

Length L [mm]	Speed [-] / Heating output [W]					
	0V	2V	4V	6V	8V	10V
800	75	399	665	873	1 039	1 172
900	98	525	876	1 150	1 369	1 545
1000	122	652	1 087	1 428	1 699	1 916
1100	145	778	1 298	1 705	2 029	2 289
1200	169	905	1 509	1 982	2 359	2 661
1300	193	1 031	1 721	2 259	2 689	3 033
1400	216	1 158	1 932	2 536	3 019	3 405
1500	240	1 284	2 143	2 814	3 349	3 777
1600	263	1 411	2 354	3 090	3 678	4 149
1700	287	1 537	2 565	3 368	4 008	4 522
1800	311	1 664	2 777	3 645	4 339	4 894
1900	335	1 791	2 987	3 922	4 669	5 266
2000	358	1 917	3 199	4 199	4 999	5 638
2100	382	2 044	3 410	4 476	5 328	6 010
2200	405	2 170	3 621	4 754	5 658	6 382
2300	429	2 297	3 832	5 031	5 988	6 755
2400	453	2 423	4 043	5 308	6 318	7 126
2500	476	2 550	4 254	5 585	6 648	7 499
2600	500	2 677	4 465	5 862	6 978	7 871
2700	523	2 803	4 676	6 140	7 308	8 243
2800	547	2 930	4 888	6 417	7 638	8 615



Acoustic power [dB(A)]

Length L [mm]	Speed [-] / Acoustic power [dB(A)]				
	2V	4V	6V	8V	10V
800	< 25	34	42	49	54
900	< 25	34	42	50	55
1 000	< 25	34	43	50	56
1 100	< 25	35	43	51	56
1 200	< 25	35	43	51	57
1 300	< 25	35	44	51	57
1 400	< 25	36	44	52	58
1 500	< 25	36	45	52	58
1 600	< 25	36	45	53	58
1 700	< 25	36	45	53	59
1 800	< 25	37	45	53	59
1 900	< 25	37	45	53	59
2 000	< 25	37	46	54	60
2 100	< 25	37	46	54	60
2 200	< 25	37	46	54	60
2 300	< 25	37	46	54	60
2 400	< 25	38	46	55	61
2 500	< 25	38	47	55	61
2 600	< 25	38	47	55	61
2 700	< 25	38	47	55	61
2 800	< 25	38	47	55	62

More details on page → 13

FRD 0135 0325

TRENCH HEATER WITH FAN TOPENÍ / COOLING, 2 PIPE



- > Fully glazed rooms with big heat gains
- > Flats, villas, residences, hotels
- > High heat output
- > Optimum after-cooling output
- > Convection with tangential fans
- > Dry environment
- > Safety voltage 24 V

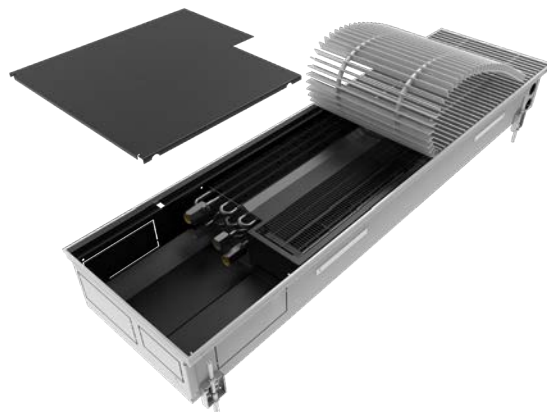

Technical data

Trench heater

Height [H]	135 mm
Width [W]	325 mm
Length [L]	800-2800 mm in step 100 mm

Heat exchanger

Type	Al-Cu lamellar
Length	L-485 mm
Connection thread	2×G1/2" inner

Working conditions

Max. temperature	110 °C
Max. overpressure	1 MPa (10 bar)
Protection	IP 20
Ambient conditions	Temp. T = +2 to +40 °C Humidity Rh = 20 to 70%

Trench heater standard equipment

Trough	Galvanized steel trough with surface finish and black spray layer inside, black cover plates of connection, inner condensate trough from stainless steel
Heat exchanger	Al-Cu lamellar exchanger with air vent valve, black painted
Grille	Design walkable grille according to the customer's choice
Ledge	Made of anodized aluminium, type and colour according to the customer's choice
Fan	Modern tangential fan with 24 V DC EC motor with high efficiency, rotors protection
Assembly elements	Leveling screws for setting up the trough, mounting brackets
Manual	Manual for the progress of work during installation and user manual
Wiring	Electrical wiring diagram of the trench heaters
Mounting board	Cover and the spacer particle board for easy installation
Package	Transport package for protection against damage during transportation and handling

Technical drawing

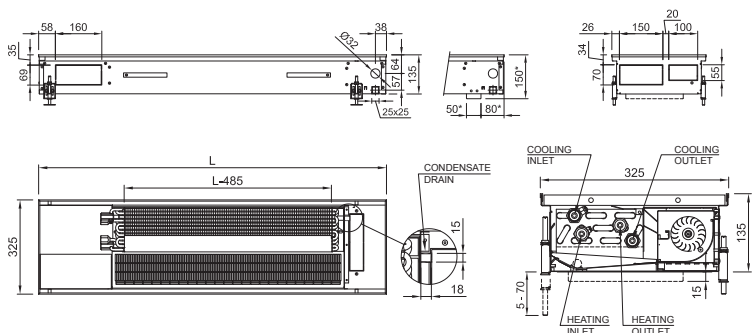

* dimension if condensate pump is used

Connection to heating system

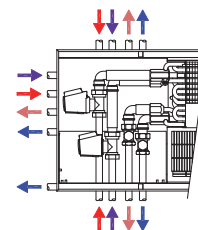

Accessories per order



Variants

Grilles

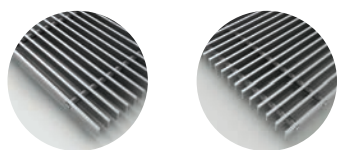

Transverse roll-up

Linear non-rolling

Peripheral ledge

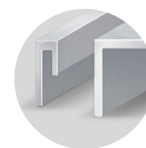

- ① Grilles → 6
- ② Ledges → 8
- ③ Acoustic power → 13
- ④ Accessories → 14
- ⑤ Hydraulic parameters → 126

Code example: FRC 0135 0325 2000 C 21 J2 L - 5

Trench heater FRC H = 135 mm, W = 325 mm, L = 2 000 mm, „C“ Galvanized steel trough with black inside, heat exchanger and inner parts painted black, „21“ bronze anodized aluminium grille, transverse, roll-up low, „J2“ peripheral ledge „J“, bronze anodized aluminium „L“ water connection at the left side (when installing the heat exchanger closer to the window, fans to the room), „5“ 24 V DC fans without controller (controller is not needed)



Trench heater heating output FRC 0135 0325, 2 pipe

Q[W] 75/65/20 °C (ΔT=50°C)

Temperature exponent 1,0473

Length L [mm]	Speed [-] / Heating output [W]					
	0V	2V	4V	6V	8V	10V
800	107	467	670	810	911	985
900	142	615	883	1 067	1 200	1 298
1000	176	763	1 096	1 324	1 489	1 610
1100	210	911	1 309	1 581	1 778	1 923
1200	244	1 059	1 522	1 838	2 067	2 236
1300	278	1 207	1 735	2 095	2 356	2 549
1400	312	1 355	1 948	2 352	2 645	2 861
1500	346	1 503	2 160	2 609	2 934	3 174
1600	381	1 652	2 373	2 866	3 223	3 487
1700	415	1 800	2 586	3 123	3 513	3 799
1800	449	1 948	2 799	3 380	3 802	4 112
1900	483	2 096	3 012	3 637	4 091	4 425
2000	517	2 244	3 225	3 894	4 380	4 738
2100	551	2 392	3 437	4 151	4 669	5 050
2200	585	2 540	3 650	4 408	4 958	5 363
2300	619	2 688	3 863	4 665	5 247	5 676
2400	654	2 837	4 076	4 922	5 536	5 989
2500	688	2 985	4 289	5 179	5 825	6 301
2600	722	3 133	4 502	5 436	6 114	6 614
2700	756	3 281	4 714	5 694	6 404	6 927
2800	790	3 429	4 927	5 951	6 693	7 239

75/65/20 °C → 75°C inlet temperature, 65°C outlet temp., 20 °C room temp. / Output 90/70/20 °C = ~ 1,22 x 75/65/20 °C / Output 70/55/20 °C = ~ 0,84 x 75/65/20 °C / Heating outputs in accordance with EN 16430



Trench heater cooling output FRC 0135 0325, 2 pipe

17/19/28 °C (ΔT10)

Temperature exponent 0,8774

Length L [mm]	Speed [-] / Cooling output [W]				
	2V	4V	6V	8V	10V
800	70	135	196	251	302
900	92	178	258	331	397
1000	114	221	320	411	493
1100	136	264	382	490	589
1200	158	307	444	570	685
1300	180	350	506	650	780
1400	202	393	569	729	876
1500	224	436	631	809	972
1600	246	479	693	889	1 068
1700	269	522	755	969	1 163
1800	291	565	817	1 048	1 259
1900	313	608	879	1 128	1 355
2000	335	651	941	1 208	1 450
2100	357	693	1 004	1 288	1 546
2200	379	736	1 066	1 367	1 642
2300	401	779	1 128	1 447	1 738
2400	423	822	1 190	1 527	1 833
2500	445	865	1 252	1 606	1 929
2600	467	908	1 314	1 686	2 025
2700	490	951	1 376	1 766	2 121
2800	512	994	1 439	1 846	2 216

Cooling outputs in accordance with EN 16430



Fans input power [W]*

Length L [mm]	Number of fans	Speed [-] / Fans input power [W]*				
		2V	4V	6V	8V	10V
800	1	1	2	3	5	8
900	1	1	2	3	6	10
1 000	1	1	2	4	8	14
1 100	1	1	3	5	10	16
1 200	1	1	3	6	14	21
1 300	2	2	4	6	11	17
1 400	2	2	4	6	12	21
1 500	2	2	4	7	14	23
1 600	2	2	5	8	18	28
1 700	1	2	4	9	20	34
1 800	2	2	5	9	21	34

* Approximate fan input powers / When using electrothermal actuator add in the trench heater's power 3 W

55/45/20 °C (ΔT30)

Length L [mm]	Speed [-] / Heating output [W]					
	0V	2V	4V	6V	8V	10V
800	52	274	392	474	534	577
900	69	360	517	625	703	760
1000	85	447	642	775	872	943
1100	102	534	767	926	1 041	1 126
1200	118	620	891	1 076	1 211	1 310
1300	135	707	1 016	1 227	1 380	1 493
1400	151	794	1 141	1 378	1 549	1 676
1500	168	880	1 265	1 528	1 718	1 859
1600	184	968	1 390	1 679	1 888	2 042
1700	201	1 054	1 515	1 829	2 057	2 225
1800	217	1 141	1 639	1 980	2 227	2 408
1900	234	1 228	1 764	2 130	2 396	2 592
2000	250	1 314	1 889	2 281	2 565	2 775
2100	267	1 401	2 013	2 431	2 735	2 958
2200	283	1 488	2 138	2 582	2 904	3 141
2300	300	1 574	2 262	2 732	3 073	3 324
2400	317	1 662	2 387	2 883	3 242	3 508
2500	333	1 748	2 512	3 033	3 412	3 690
2600	350	1 835	2 637	3 184	3 581	3 874
2700	366	1 922	2 761	3 335	3 751	4 057
2800	382	2 008	2 886	3 485	3 920	4 240



Acoustic power [dB(A)]

Length L [mm]	Speed [-] / Acoustic power [dB(A)]				
	2V	4V	6V	8V	10V
800	< 25	34	42	49	54
900	< 25	34	42	50	55
1 000	< 25	34	43	50	56
1 100	< 25	35	43	51	56
1 200	< 25	35	43	51	57
1 300	< 25	35	44	51	57
1 400	< 25	36	44	52	58
1 500	< 25	36	45	52	58
1 600	< 25	36	45	53	58
1 700	< 25	36	45	53	59
1 800	< 25	37	45	53	59
1 900	< 25	37	45	53	59
2 000	< 25	37	46	54	60
2 100	< 25	37	46	54	60
2 200	< 25	37	46	54	60
2 300	< 25	37	46	54	60
2 400	< 25	38	46	55	61
2 500	< 25	38	47	55	61
2 600	< 25	38	47	55	61
2 700	< 25	38	47	55	61
2 800	< 25	38	47	55	62

More details on page → 13

FRB

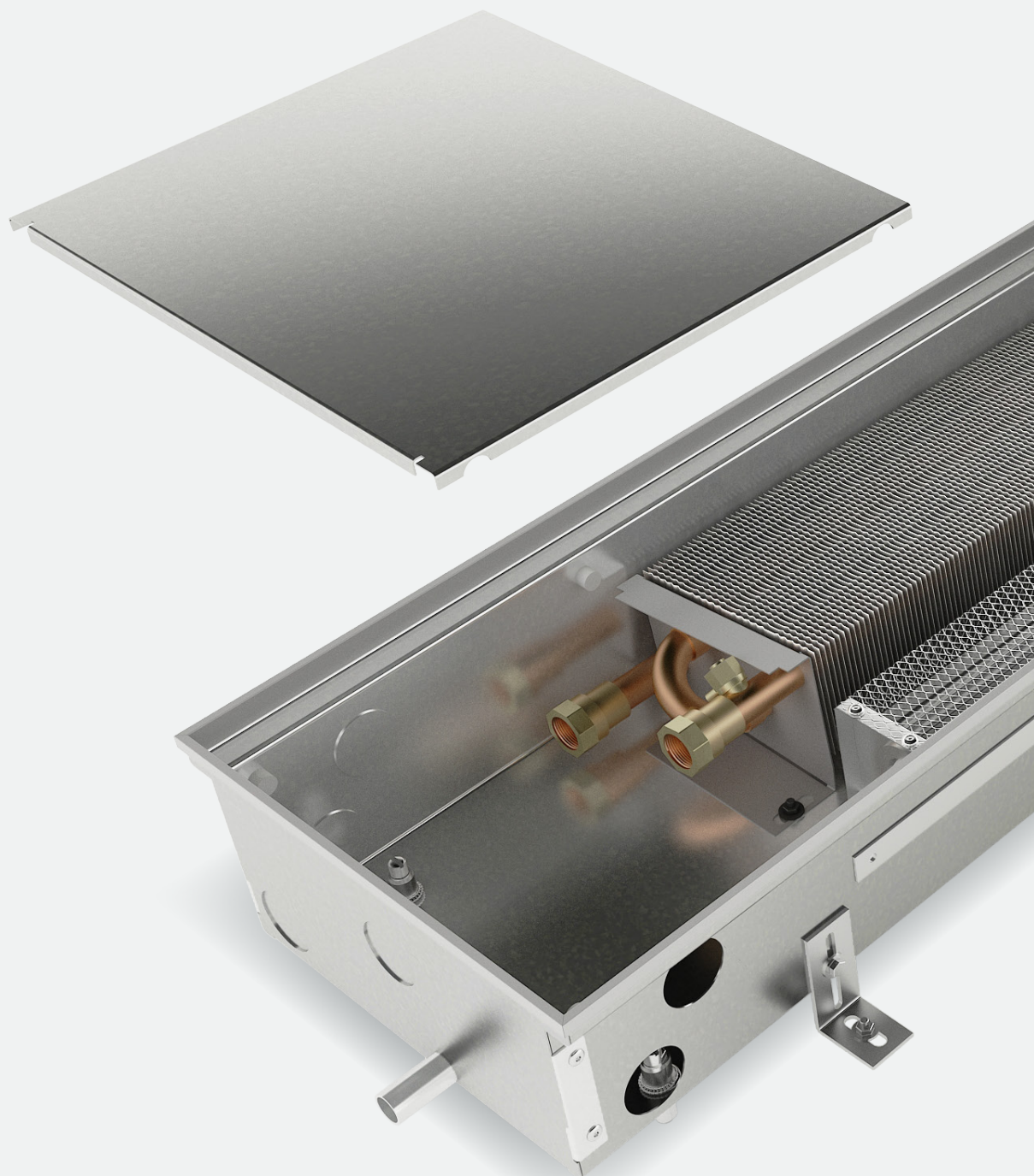

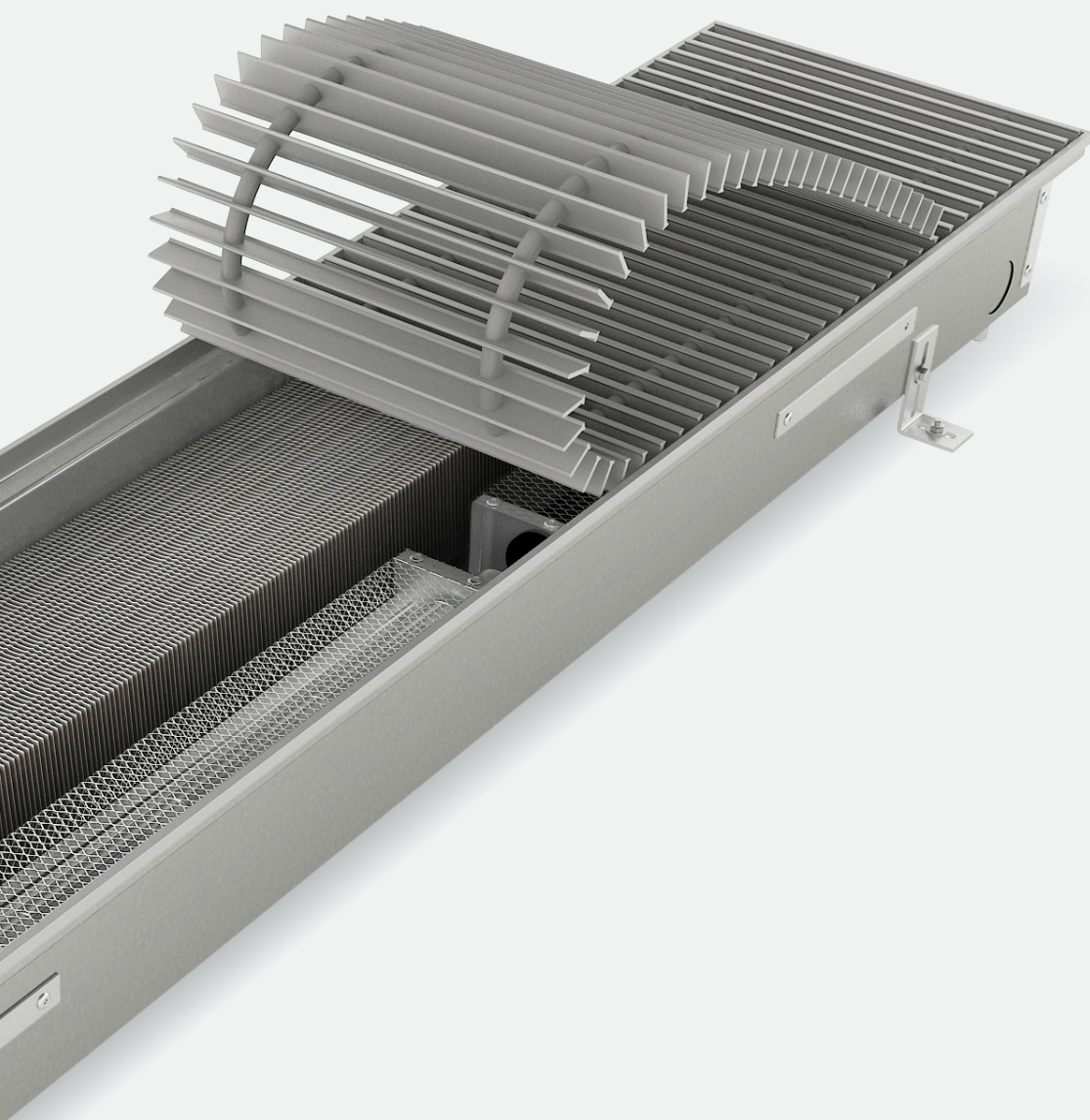

Fan-assisted trench heaters with
a **lamellar exchanger for a humid
environment, heating**

TERMO FRB

Fan-assisted heaters for a humid environment



Benefits

- › Use in a humid environment
- › Conservatories, greenhouses, bathrooms, saunas
- › Garages, warehouses, halls, stadiums
- › Pools, no submersion in water
- › High heater output
- › Safe voltage of 24 V DC
- › Energy-saving fans
- › Quiet operation
- › Continuous speed control
- › Length 700-4 800 mm (in step 100 mm)



FRB trench heaters are constructed to be used in conditions with higher moisture and possible water condensation. The heater structure is made of stainless steel resistant even to an aggressive environment and fitted with small drainage tubes along its sides. Tangential fans provide higher resistance against water (both with their structure and electrical protection). Only metal grilles are used for FRB; if a wooden grille is used, its surface must be treated to prevent its degradation (e.g. with boat varnish).

FRB trench heaters are suitable for installation in swimming pool environments (except for salt water pools). The heaters may come in contact with pool water but must not be fully submerged. The heating unit must be placed at a sufficient distance from the pool to prevent permanent flooding.

FRB trench heaters achieve high heating outputs. Tangential fans are fitted with effective electrically commuted (EC) motors functioning on the basis of

the safe voltage of 24 V DC. The motors have a very low consumption of electric power. The fan speed is controlled continuously with a controlling voltage of 0...10 V DC. A room thermostat secures the correct function of all installed FRB trench heaters, compares the set and actual temperatures in the room, opens the flowing of the heating medium in the exchanger and controls the fan revolutions according to the difference in the temperatures and the set mode of operation.

The use of new technologies secures optimal heating of the interior, energy savings, high efficiency and flexibility of heating. The trench heater is powered with safe voltage only, all components are powered with 24 V DC. The substantial range of heights and widths of trench heaters gives the designer numerous options for selecting a model with the required output for the composition of the floor in question.

The range of FRB models with a fan 24 V DC

Height	65 mm	80 mm	90 mm	110 mm	125 mm	140 mm
Width	-	-	-	-	-	-
	-	-	200 mm	200 mm	-	-
	-	-	250 mm	250 mm	250 mm	250 mm
	-	-	300 mm	300 mm	-	-
	-	-	425 mm	425 mm	-	-

Trench heater standard equipment

Trough	Trough of stainless steel DIN 1,4404, unpainted
Heat exchanger	Al-Cu lamellar exchanger with air vent valve, unpainted
Grille	Grille as selected by the customer; wooden grilles must be provided with appropriate surface finish (stainless grilles surcharge)
Ledge	Made of anodized aluminium, type and colour according to the customer's choice
Fan	Fans 24 V DC with EC motors with higher protection grade, suitable for humid environments
Assembly elements	Leveling screws for setting up the trough, mounting brackets
Manual	Manual for the progress of work during installation and user manual
Wiring	Electrical wiring diagram of the trench heaters
Mounting board	Cover and the spacer particle board for easy installation
Package	Transport package for protection against damage during transportation and handling

Accessories per order



Grilles

Non-corroding metal grilles are most frequently used in a damp environment. If a wooden grille is chosen, its surface must be treated accordingly.

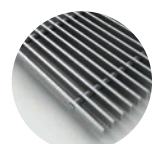

FRB overview of trench heaters with fan

175

200

250

300

425

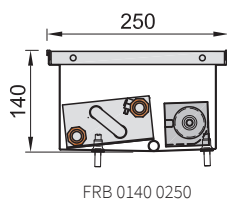
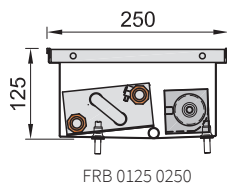
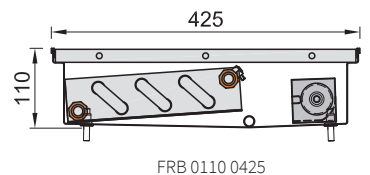
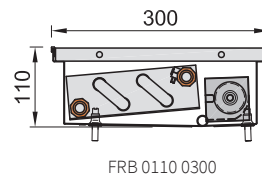
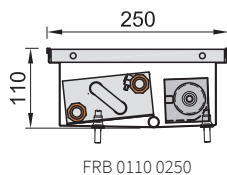
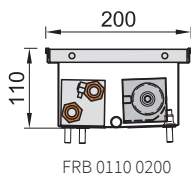
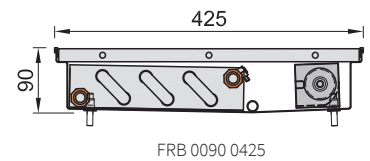
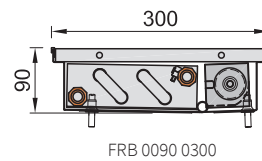
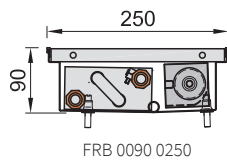
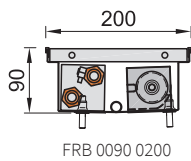

Thermal output of FRB trench heater

FRB trench heaters have an identical internal arrangement of components as FRT heaters. Their thermal output, acoustic parameters, electrical input and other specifications may be found at the dimensionally similar FRT model.

Example:

Heating output FRB 110x250x1600, speed 2, temperature gradient 75/65/20°C

FRB 0110 0250 1600 = FRT 0110 0250 1600 (page 65)

Temperature gradient: 75/65/20°C

Speed: 4V

Output Q = 1 705 W

Acoustic power 29 dB

Input power 3 W

Q[W] 75/65/20°C (ΔT=50°C)

Temperature exponent 1,031

Length L [mm]	Speed [-] / Heating output [W]					
	0V	2V	4V	6V	8V	10V
700	82	220	435	621	778	906
800	102	293	580	828	1038	1209
900	123	351	696	994	1245	1450
1000	143	498	986	1408	1764	2055
1100	163	498	986	1408	1764	2055
1200	184	585	1160	1657	2076	2417
1300	204	644	1276	1822	2283	2659
1400	224	717	1421	2029	2543	2961
1500	245	790	1566	2236	2802	3263
1600	265	861	1705	2435	3051	3553
1700	285	861	1705	2435	3051	3553
1800	305	995	1971	2816	3528	4109
1900	326	1080	2140	3056	3829	4460
2000	346	1153	2285	3263	4089	4762

see the range of lengths and outputs of the relevant FRT model

FRZ, FZC, FZD

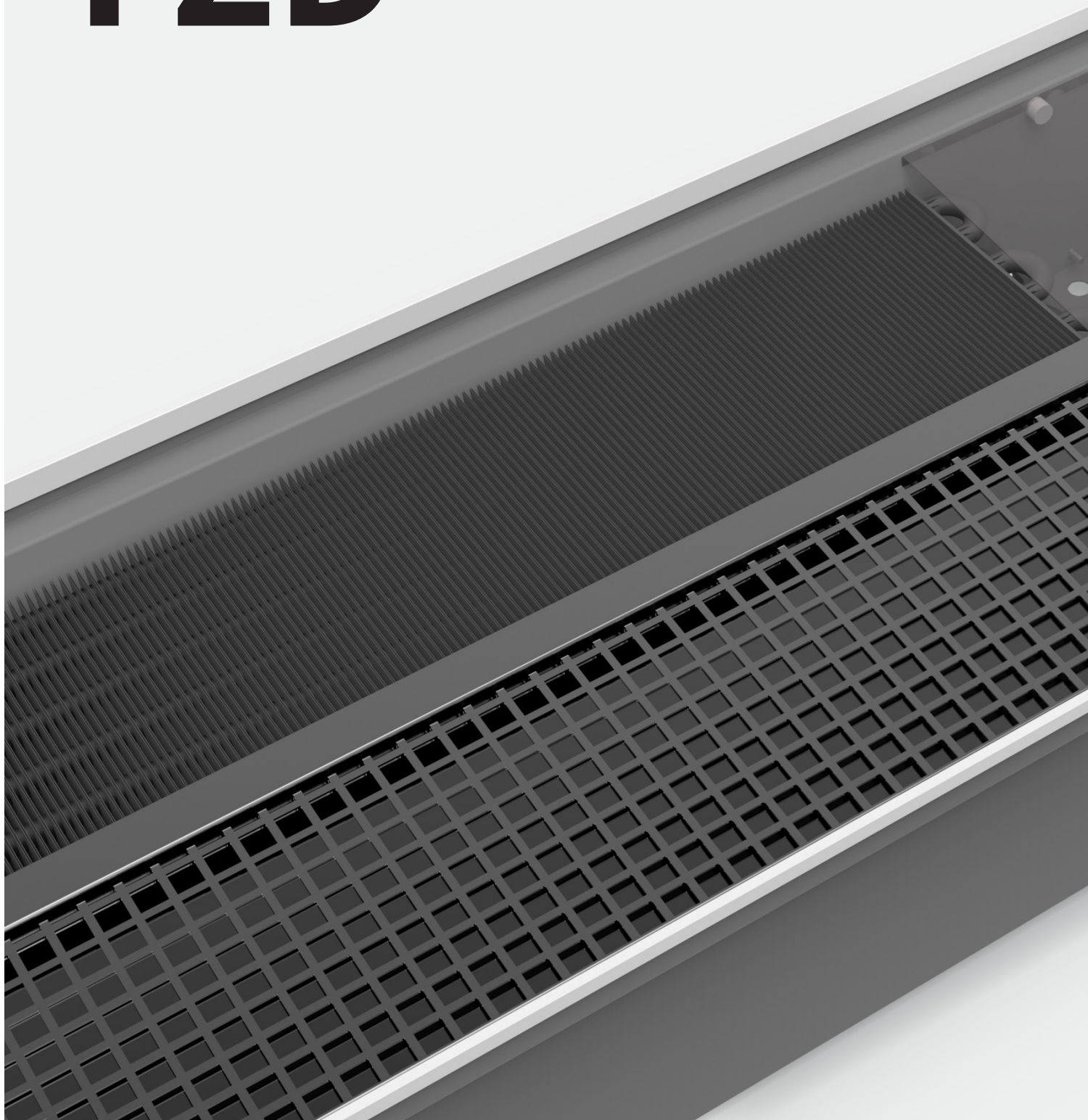

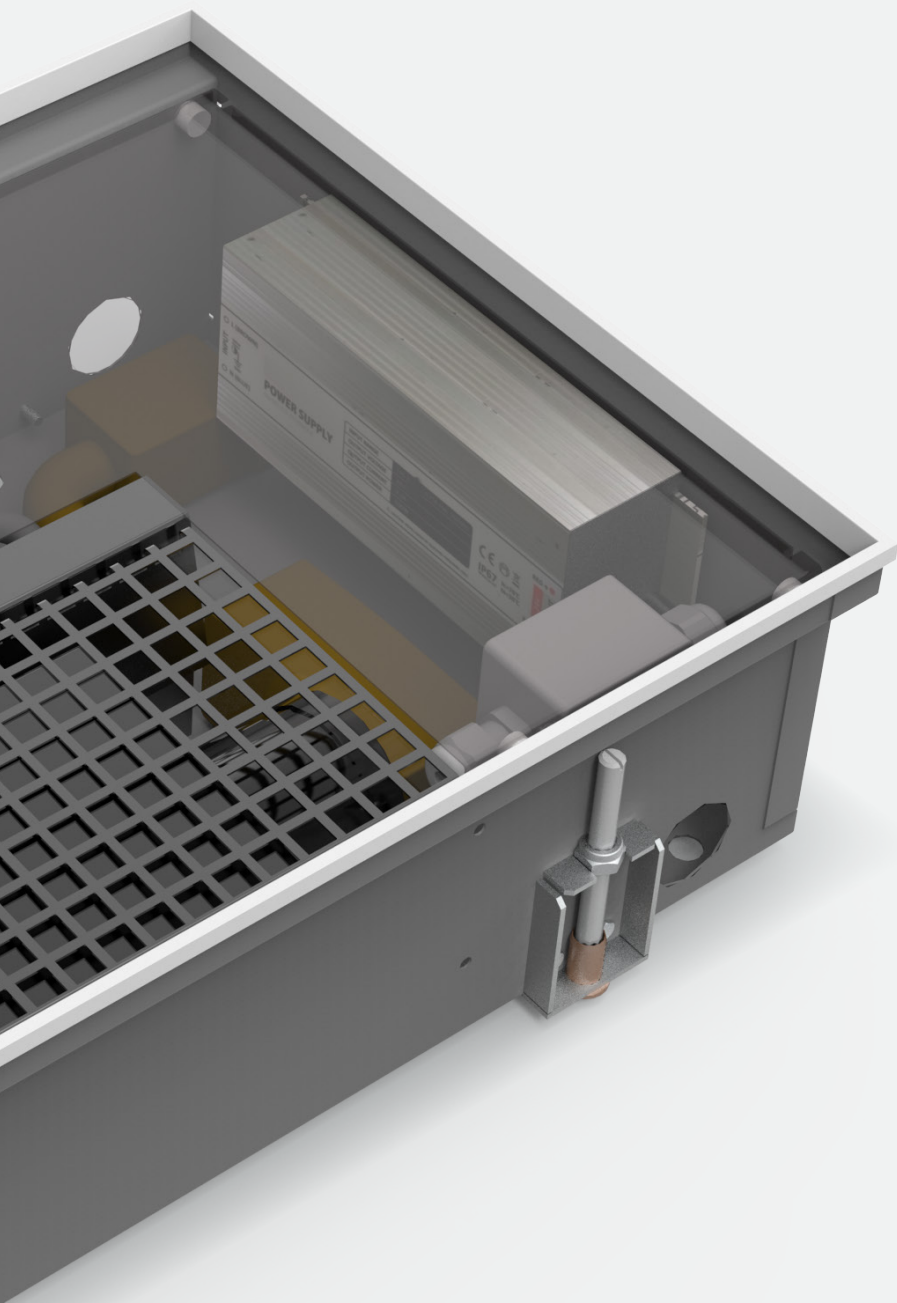

Fan-assisted trench heaters **with installed power supply** of 24 V DC

TERMO FRZ

Fan-assisted trench heaters with installed power supply



Advantages

- › Easy connection of a higher number of heaters
- › Connection at long distances
- › Connection with IP67 electrical protection
- › Negligible loss of voltage
- › Easy incorporation into smart buildings
- › Model range identical to that of FRT heaters
- › Length **900-4 800 mm** (in step 100 mm)

Areas of use

- › Shopping centres, administrative buildings
- › Recreation and sport complexes, gyms, wellness
- › Conference rooms
- › Restaurants, cafés, hotels



For bigger projects where a high number of heaters are controlled simultaneously and individual sums of cabling distances are in tens of metres, it is advantageous to design **FRZ heaters with installed power supplies**.

The network need not be dimensioned upon the electrical output; the heaters are powered from their own power supplies. It also simplifies those

projects where it is not clear until the last moment how many heaters there will be in individual rooms (for example depending on floor spaces rented in shopping centres).

The connection may be flexibly modified, individual units may be easily separated and completed with a room thermostat.

The range of FRZ models

Height	65 mm	80 mm	90 mm	110 mm	125 mm	140 mm
Width	-	175 mm	175 mm	175 mm	-	-
	-	200 mm	200 mm	200 mm	-	-
	250 mm	250 mm	250 mm	250 mm	250 mm	250 mm
	300 mm	300 mm	300 mm	300 mm	300 mm	300 mm
	-	-	425 mm	425 mm	425 mm	425 mm

Design

A power supply is placed in the trench heater which converts the mains voltage of 230 V AC to a low DC voltage of 24 V DC. Connection safety is ensured by using components with IP67 electrical protection, which can even withstand submersion in water. All elements inside the trench heater - the tangential fan and electrothermal actuator - work on a safe DC voltage. The same applies to the RTD201 and RTM201 room thermostats.

Code example: FRZ 0090 0250 2400 C 64 L2 L - 5

Trench heater with integrated power supply FRZ H = 90 mm, W = 250 mm, L = 2 400 mm, „C“ Galvanized steel trough with black inside, heat exchanger and inner parts painted black, „64“ stained oak grille, transverse, roll-up „L2“ peripheral ledge „L“ with an overlap, bronze anodized aluminium, „L“ water connection at the left side (when installing the heat exchanger closer to the window, fans to the room) „5“ 24 V DC fans without controller (controller is not needed)

Output

In the output tables of the TERMO FRT trench heaters, parameters of the 200 mm shorter heater should be considered. Because of the high coverage of the exchanger by the fans in each length, the change in performance is generally not significant. The trench heater achieves its initial performance with a slight increase in the fan speed, which is enabled by continuous control of the thermostat.

Example output determination for FRZ 0090 0250 heater, temperature gradient 75/65/20°C →

Length L [mm]	Speed [-] / Heating output [W]					
	0 V	2 V	4 V	6 V	8 V	10 V
1400	215	826	1314	1749	2130	2458
1500	235	910	1448	1927	2347	2709
1600	254	991	1577	2098	2556	2949
1700	274	991	1577	2098	2556	2949
1800	293	1146	1823	2427	2956	3411
1900	313	1244	1979	2634	3208	3702
2000	332	1328	2113	2812	3425	3953

Assembly

The space required for the installed power supply is 200 mm. For the same trench heater length, the installed elements are therefore identical to the 200 mm shorter FRT trench heater. The installation of the trench heater and its connection to the heating system are the same as with the standard trench heater.

Difference in the installation of interior elements in standard trench heaters and trench heaters with an installed power supply.

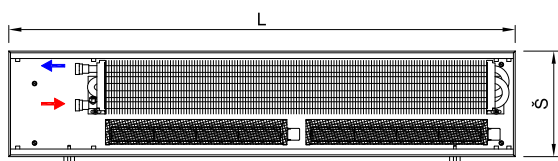

STANDARD TRENCH HEATER DESIGN (FRT designation)

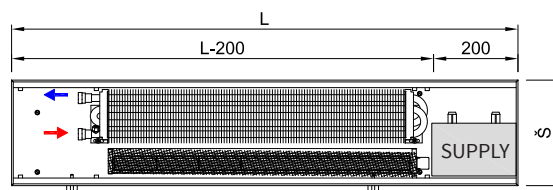

TRENCH HEATER WITH INSTALLED POWER SUPPLY (FRZ designation)

Regulation

For the proper function of the trench heaters, control and regulatory elements should be added. The room temperature is assessed by the room thermostat (RTD201, RTM201) which controls the fan speed and the flow of the heating medium through the exchanger. The flow is regulated using the Z-TS24 electrothermal actuator, which opens or closes the Z-TD001 thermostatic valve. The thermostatic valve is installed at the input to the heat exchanger. For the proper adjustment of the flow volume of the heating medium, it is necessary to install and set the Z-RD001 lockshield at the output of the exchanger.

If more than 10 trench heaters are installed, the RL10 relay for opening additional actuators is incorporated. Fans with motors with EC technology are controlled by a voltage of 0 ... 10 V DC, and electrothermal actuators are controlled with a switching voltage of 24 V DC. Such control allows easy integration into buildings with a BMS (Building Management System) central control. When the European KNX standard is used, it is appropriate to control trench heaters with the RTD201KN thermostat with implemented KNX communication.

Control elements of FRZ trench



RTD201

Digital thermostat



RTM201

Manual thermostat



Z-TS24

Electrothermal actuator



Z-TD001

Thermostatic valve



Z-RD001

LockShield valve

Further information about accessories may be found in FRT product range on page 14.

Circuit diagram

An alternating voltage of 230 V AC is fed to the trench heater with a power supply. There it is transformed into a safe voltage of 24 V DC. All the elements of the trench heater (fans, electrothermal actuators and the room thermostat) then work with it.

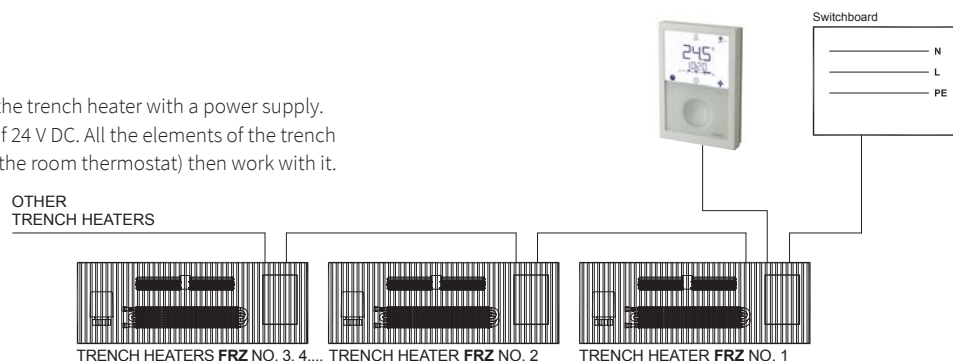

TERMO FZC, FZD

Fan-assisted heaters with installed power supply



Advantages

- › Easy connection of a higher number of heaters
- › Connection at long distances
- › Connection with IP67 electrical protection
- › Negligible loss of voltage
- › Easy incorporation into smart buildings
- › Model range identical to that of FRC, FRD heaters

FRT 0100 0175

Lengths 800 - 2 800 mm in step 400 mm (FZC 100x175 1000-3 000 mm)

FRT 0135 0325

Lengths 800 - 2 800 mm in step 100 mm



Areas of use

- › Shopping centres, administrative buildings
- › Recreation and sport complexes, gyms, wellness
- › Conference rooms
- › Restaurants, cafés, hotels

For bigger projects where a high number of heaters are controlled simultaneously and individual sums of cabling distances are in tens of metres, it is advantageous to design FZC, FZD heaters with installed power supplies. This option should be considered especially for 135 x 325 mm heaters with higher input for the maximum revolutions in cooling, if more than two units are to be installed per room.

For FZC and FZD the network need not be dimensioned upon the electrical output; the heaters are powered from their own installed power supplies. It also simplifies those projects where it is not clear until the last moment how many heaters there will be in individual rooms (for example depending on floor spaces rented in shopping centres). The connection may be flexibly modified, individual units may be easily separated and completed with a room thermostat.

Design

A power supply is placed in the trench heater which converts the mains voltage of 230 V AC to a low DC voltage of 24 V DC. Connection safety is ensured by using components with IP67 electrical protection, which can even withstand submersion in water. All elements inside the trench heater - the tangential fan and electro-thermal actuator - work on a safe DC voltage. The same applies to the RTD201 and RTM201 room thermostats.

The range of FZC models

- › **FZC 0100 0175**
installed power supply
FRC 0100 0175
The FZC trench heater is 200 mm longer than FRC
- › **FZC 0135 0325**
installed power supply
FRC 0135 0325

The range of FZD models

- › **FZD 0135 0325**
installed power supply
FRD 0135 0325

Height	100 mm	135 mm
Width	175 mm	-
	-	325 mm

Height	100 mm	135 mm
Width	-	-
	-	325 mm

Code example: FZC 00135 0325 1800 C 11 J1 L - 5

Trench heater **FZC** with integrated power supply H = **135** mm, W = **325** mm, L = **1800** mm, „C“ Galvanized steel trough with black inside, heat exchanger and inner parts painted black, „11“ natur anodized aluminium grille, transverse, roll-up „J1“ peripheral ledge „J“, natur anodized aluminium, „L“ water connection at the left side (when installing the heat exchanger closer to the window, fans to the room), „5“ 24 V DC fans without controller (controller is not needed)

Heating and cooling output, acoustic parameters

All parameters of heating and cooling outputs, acoustic parameters and other quantities are identical to the FRC and FRD trench heaters. The only deviation is in the FCZ 0100 0175, where the trench length is 200 mm longer compared to the FRC 0100 0175.

- > **FZC 0100 0175** → FRC 0100 0175 page 86
- > **FZC 0135 0325** → FRC 0135 0325 page 88
- > **FZD 0135 0325** → FRD 0135 0325 page 90

Example output determination for FZC 0100 0175 heater, temperature gradient 75/65/20°C →

Length L [mm]	Speed [-] / Heating output [W]				
	0 V	1 V	2 V	3 V	4 V
800	23 W	104 W	240 W	479 W	673 W
1200	45 W	235 W	545 W	1 087 W	1 526 W
1600	67 W	339 W	785 W	1 566 W	2 199 W
2000	89 W	471 W	1 089 W	2 173 W	3 052 W

FZC 0100 0175 with installed power supply – 200 mm longer

Due to the small interior space in the 100 x 175 heater it is necessary to make it 200 mm longer if a switched power supply is to be installed.

LENGTHS OF FZC 0100 0175 HEATERS WITH POWER SUPPLY:

L = 1000, 1400, 1800, 2200, 2600 a 3000 mm.

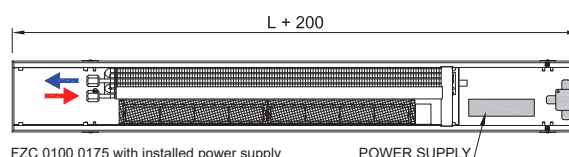
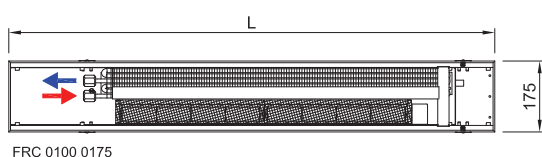

FZC, FZD 0135 0325 with installed power supply

The switched power supply is located in the space for the connecting the electrical wiring. The heater looks the same as the one without the power supply.

LENGTHS OF FZC 0135 0325 HEATERS WITH POWER SUPPLY:

L = 800-2800 mm in step 100 mm

All parameters of the heater are identical to the model without the installed power supply FRC 0135 0325 (page 88) or FRD 0135 0325 (page 90).

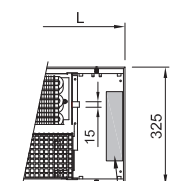
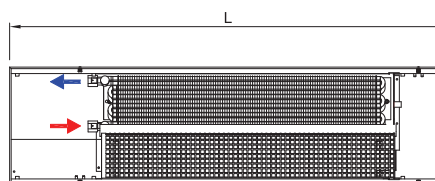

Control elements of FZC, FZD trench heaters



RTD201
Digital thermostat



RTM201
Manual thermostat



Z-TS24
Electrothermal actuator



Z-TD001
Thermostatic valve



Z-RD001
LockShield valve

Further information about accessories may be found in FRT product range on page 14.

Circuit diagram

An alternating voltage of 230 V AC is fed to the trench heater with a power supply. There it is transformed into a safe voltage of 24 V DC. All the elements of the trench heater (fans, electrothermal actuators and the room thermostat) then work with it.

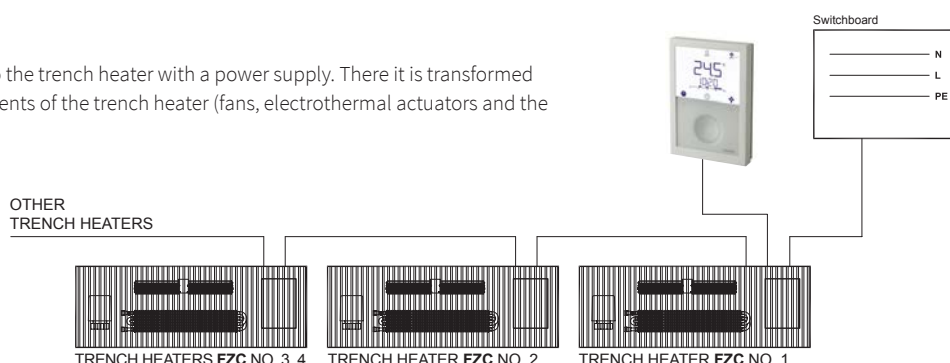

TERMO for the heating system with natural convection



TERMO trench heaters with natural convection are installed under glazing covering the entire area of buildings. Trench heaters form a thermal barrier to keep the flow of cold air from the window surface. A part of warm air is directed inwards and heats residential spaces. The trench heaters are normally used as additional heating combined with other types of heating. If the heat output of the trench heater is sufficient the trench heater may also be used as the main heating

system. These trench heaters are also suitable to adjust temperatures in entrance halls, commercial areas and long corridors.

A great range of the heights and widths of the trench heaters gives the designer many options how to fit the model with the required output in the configuration of the floor. Necessary data are presented in data sheets for individual products.

The range of models with natural convection

Heating	Humid environment
FRK <ul style="list-style-type: none"> > heating > natural convection > lamellar exchanger > dry environment > page 106 	FRM <ul style="list-style-type: none"> > heating > natural convection > lamellar exchanger > humid environment > page 124

Working conditions

- > Installation in a hot water heating system with forced circulation
- > Maximal operating temperature of heating medium 110 °C
- > Maximal operating overpressure 1 MPa
- > Ambient temperature +2 to +40 °C
- > Relative humidity of environment 20 to 70% (FRM 20-100%)

Placement in the floor

The trench heaters are laid in the floor so that the exchanger is closer to the window side. The vertical and horizontal distribution of temperatures in the heated room is uniform and conditions are created to provide thermal comfort. Air flow is comparable to the heat transfer with classical heating bodies placed on the wall below windows.

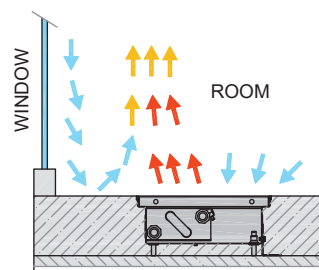

Connecting the heating system

The lamellar **Al-Cu** heat exchangers have aluminium lamellas pressed onto a copper pipe. The heating medium flows through this pipe.

The inlet and outlet of the pipe is provided with a connecting end with internal thread G1/2". Normally the water connection of the heat exchanger is on the left side (when the heat exchanger is placed nearer the window).

We install a thermostatic valve fitted with an electrothermal actuator on the inlet of the lamellar heat exchanger. The actuator works in the opened/closed mode and controls the flow of the heating medium.

The second option is to use a mechanical thermostat with a capillary. The regulation is proportional, no electric power is necessary. However each trench heater shall be fitted with its own thermostat with a capillary. Suitable for single long heating bodies.

It is not necessary to use a thermostatic valve if the temperature of the heating medium is controlled by the heating system (e.g. equithermal system). The way of regulation is to be determined by the designer of the heating and this shall be specified in the project documentation.

A return regulating screw connection shall be used for the outlet. This enables the incorporation of the trench heater into the heating system from the viewpoint of the hydraulic balancing. Based on the parameters of the screw connection used the designer determines the setting (corresponding to pressure loss at the fitting) and this value shall be specified in the project documentation.

Each exchanger is fitted with an air vent valve. When the heating system is connected and filled air bubbles remain caught in the upper part of the exchanger. These shall be let out through the air vent valve.

Connection with an electrothermal actuator

Connection of the electrothermal actuator 24 V DC

The thermostat opens and closes the flow of heating medium through the heat exchanger in dependence on temperature changes in the room. The flow is controlled with an electrothermal actuator 24 V DC. The connection will be used if there is the requirement for safe voltage of 24 V DC in the trench heater or if the trench heaters are combined with the FRT ventilator in a single room. In such case the trench heater is connected to a shared thermostat. Regulation takes place in the opened/closed mode (ON/OFF).

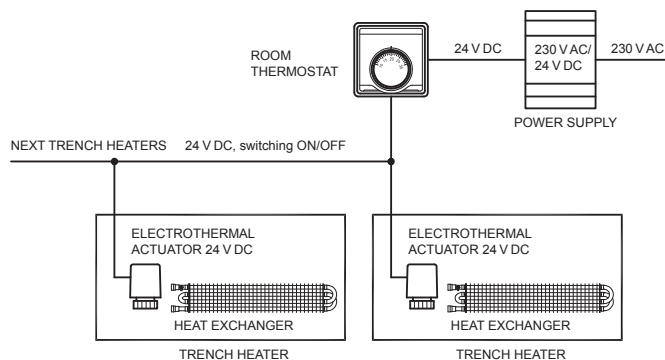

Connection of the electrothermal actuator 230 V AC

Simplified connection using the voltage of 230 V AC for trench heaters with natural convection FRK. Simple cabling, a thermal actuator with IP54 protection. Regulation takes place in the opened/closed mode (ON/OFF).

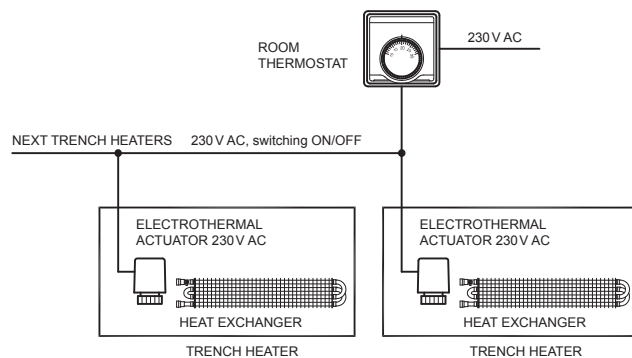

Connection with the capillary thermostat

The capillary thermostat automatically maintains a preset temperature in the room. The temperature is regulated in dependence on the user's requirements without the need for other energy sources. Maintaining the preset temperature is secured by air flowing around the thermal sensor. The thermostatic valve will release only such amount of water into the heating body that is needed to maintain the set temperature in the room. The capillary thermostat is installed to each trench heater.

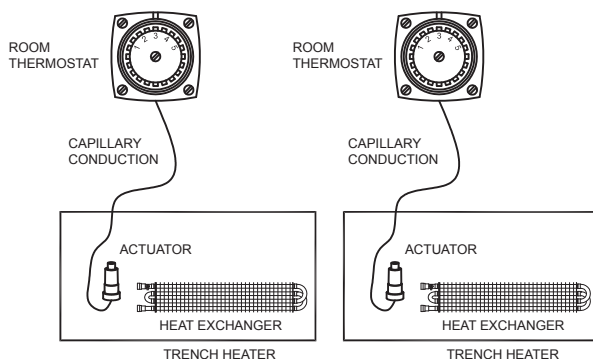

The output of the trench heater

The tables contain output data for thermal gradient 75/65/20°C, standardized output according to standard ČSN EN 16 430-2. This standard also defines the procedure for conversion to other thermal gradients. The second table presents a converted thermal gradient of 55/45/20°C and a fast approximate conversion for gradients of 90/70/20°C and 70/55/20°C.

Hydraulics

The table with hydraulic resistance is presented on page 126.

Trench heater „made to measure“

Based on the requirements of larger projects it is possible to supply a “made to measure” trench heater with adjusted height and width. Having approved the structure we will submit a protocol from a test room presenting output parameters. We also offer modifications of the trench heater for the use in humid environment, the connection of air handling piping and others. The technical documentation is first consulted with the customer and only then the production of the trench heater starts.

FRK

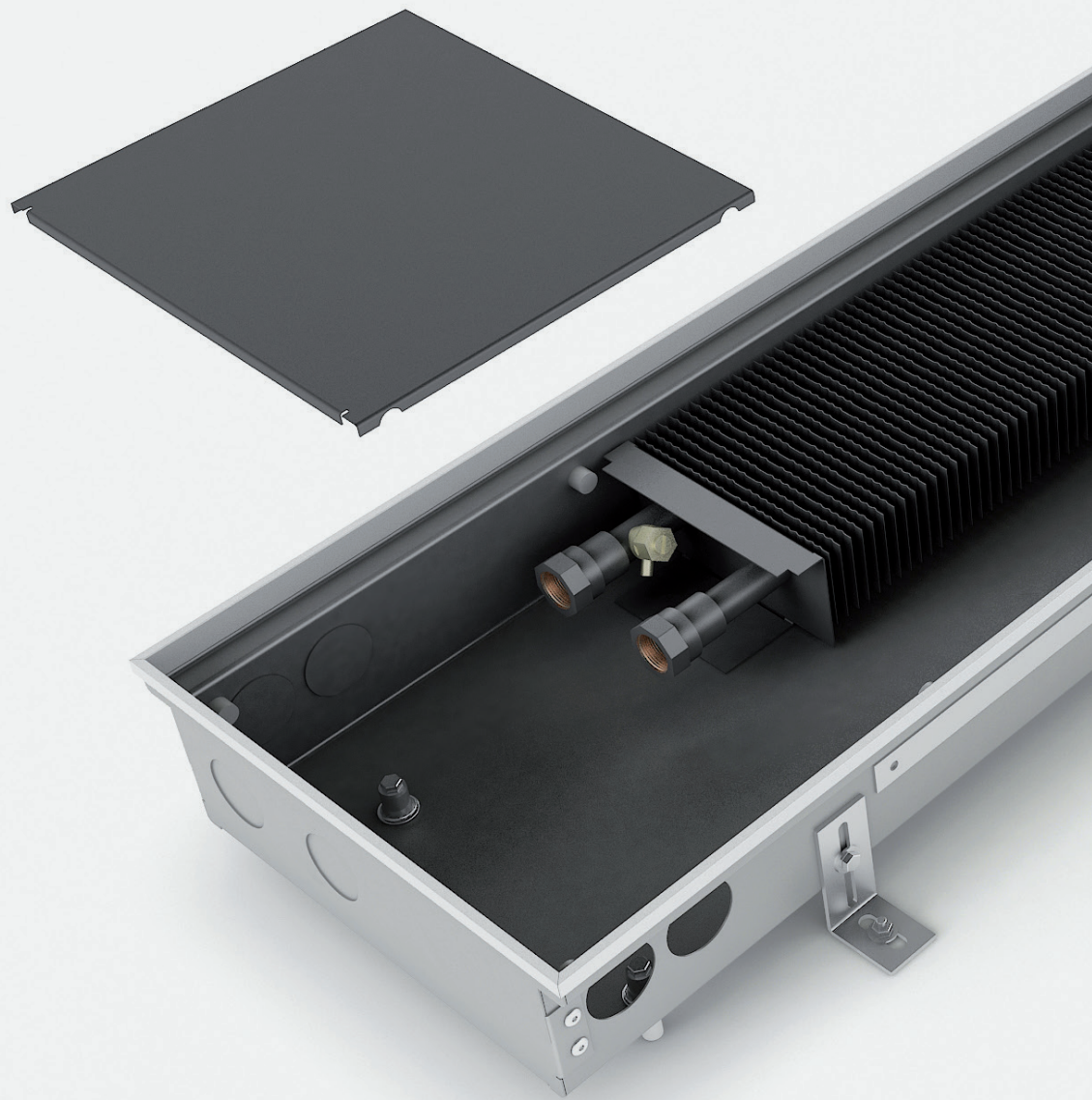

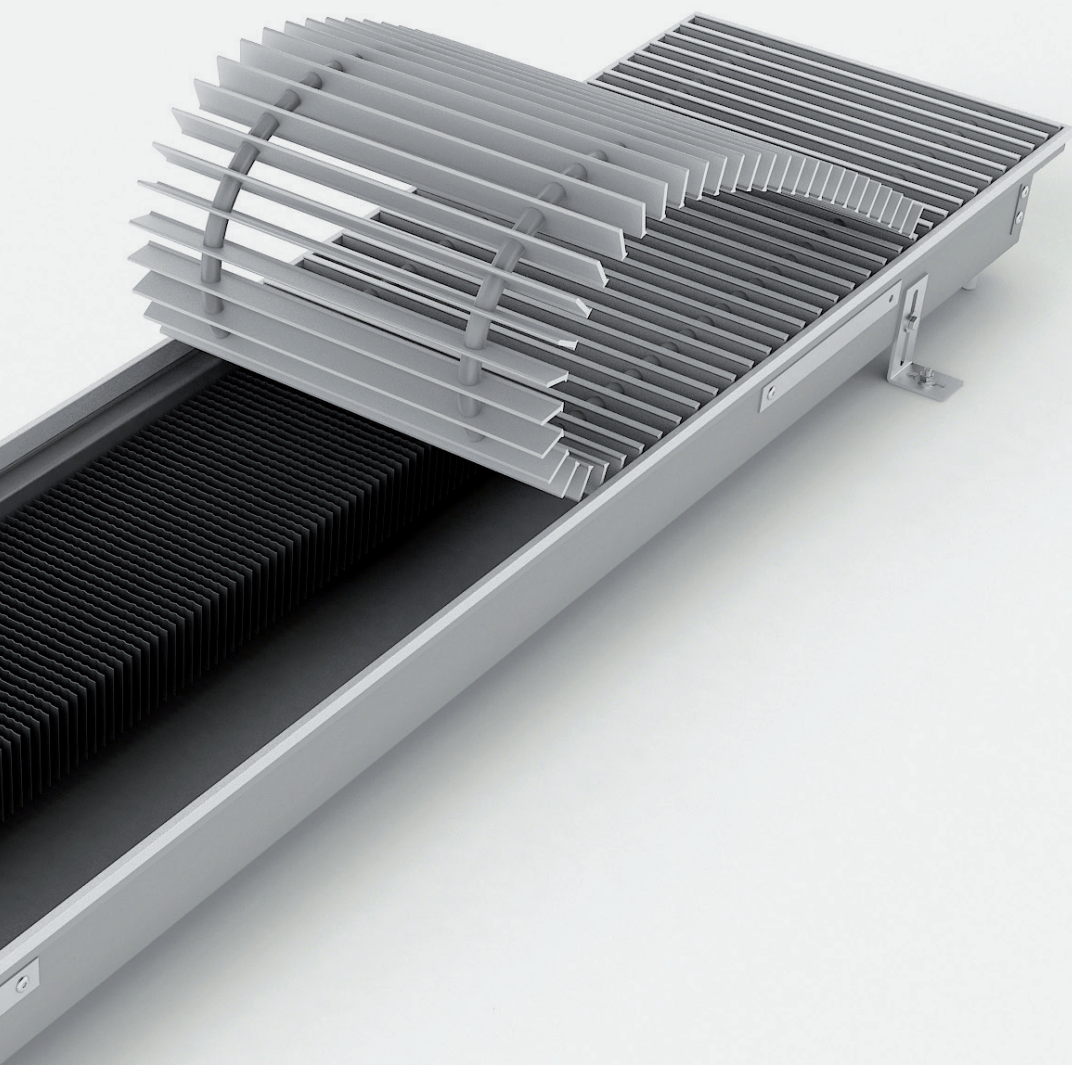

Trench heaters with **natural convection and lamellar exchanger, heating**

TERMO FRK

trench heaters with natural convection

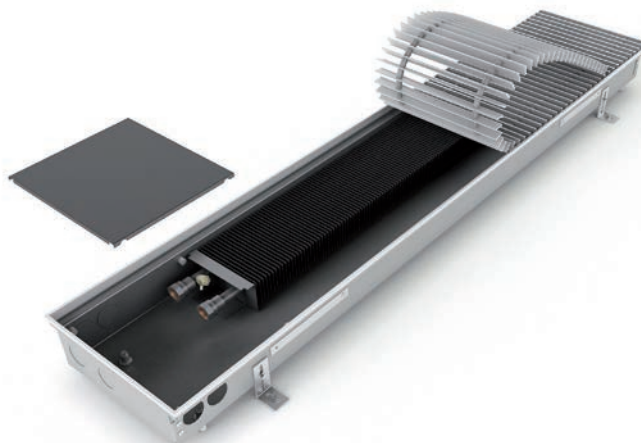

FRK trench heaters with natural convection are installed under glazing covering the entire area of buildings. Trench heaters form a thermal barrier to keep the flow of cold air from the window surface. A part of warm air is directed inwards and heats residential spaces. The trench heaters are normally used as additional heating combined with other types of heating. If the heat output of the trench heater is sufficient the trench heater may also be used as the main heating system. These trench heaters are also

suitable to adjust temperatures in entrance halls, commercial areas and long corridors.

A great range of the heights and widths of the trench heaters gives the designer many options how to fit the model with the required output in the configuration of the floor. Necessary data are presented in data sheets for individual products.

The range of FRK models with natural convection

Height	80 mm	90 mm	110 mm	125 mm	140 mm	165 mm	200 mm
Width	-	175 mm	175 mm	175 mm	175 mm	-	-
	-	200 mm	200 mm	200 mm	200 mm	-	-
	250 mm	250 mm	250 mm	250 mm	250 mm	-	-
	300 mm	300 mm	300 mm	300 mm	300 mm	300 mm	300 mm
	-	350 mm	350 mm	350 mm	350 mm	350 mm	350 mm
	-	425 mm	425 mm	425 mm	425 mm	425 mm	425 mm

Placement in the floor

The trench heaters are laid in the floor so that the exchanger is closer to the window side. The vertical and horizontal distribution of temperatures in the heated room is uniform and conditions are created to provide thermal comfort.

Air flow is comparable to the heat transfer with classical heating bodies placed on the wall below windows.

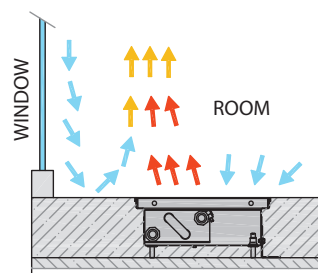

FRK an overview of trench heaters with natural convection

175

200

250

300

350

425

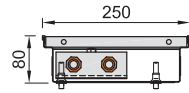

FRK 0080 0250
page 108

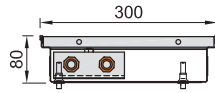

FRK 0080 0300
page 108

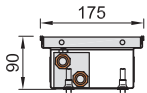

FRK 0090 0175
page 110

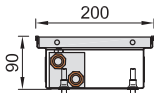

FRK 0090 0200
page 110

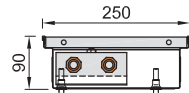

FRK 0090 0250
page 110

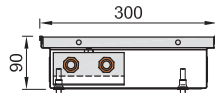

FRK 0090 0300
page 110

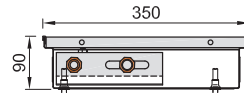

FRK 0090 0350
page 110

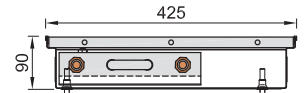

FRK 0090 0425
page 110

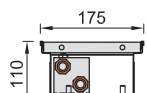

FRK 0110 00175
page 112

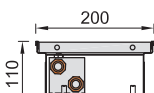

FRK 0110 0200
page 112

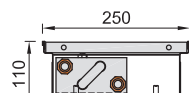

FRK 0110 0250
page 112

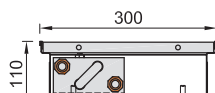

FRK 0110 0300
page 112

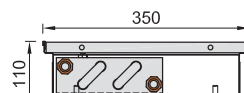

FRK 0110 0350
page 112



FRK 0110 0425
page 112

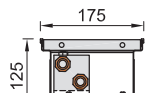

FRK 0125 0175
page 114

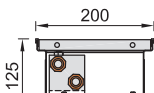

FRK 0125 0200
page 114

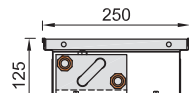

FRK 0125 0250
page 114

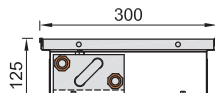

FRK 0125 0300
page 114

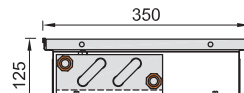

FRK 0125 0350
page 114

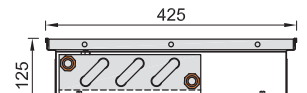

FRK 0125 0425
page 114

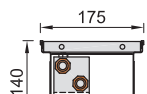

FRK 0140 0175
page 116

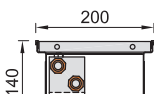

FRK 0140 0200
page 116

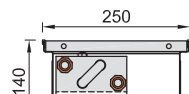

FRK 0140 0250
page 116

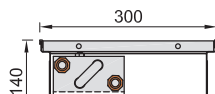

FRK 0140 0300
page 116

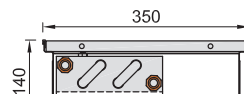

FRK 0140 0350
page 116

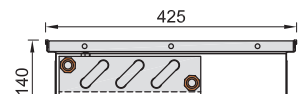

FRK 0140 0425
page 116

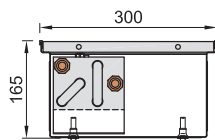

FRK 0165 0300
page 118

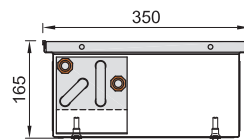

FRK 0165 0350
page 118

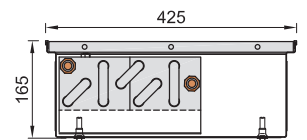

FRK 0165 0425
page 118

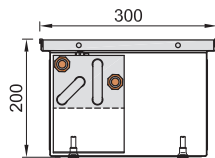

FRK 0200 0300
page 120

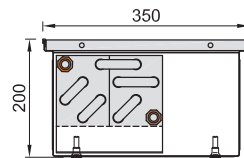

FRK 0200 0350
page 120

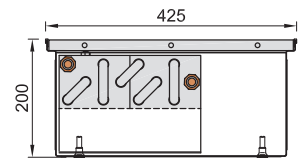

FRK 0200 0425
page 120

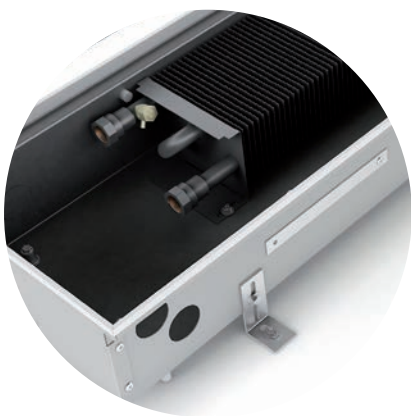

FRK 0080 0250/0300

TRENCH HEATERS WITH NATURAL CONVECTION



- > Offices, corridors, halls, flats, winter garden
- > High heating output of natural convection
- > Suitable for combining with other heating systems
- > Using in dry environment
- > 2pipe system



FRK 0080 0250

Technical data

Trench heater

Height [H]	140 mm
Width [W]	175, 200, 250, 300, 350, 425 mm
Length [L]	L = 700–4 800 mm in step 100 mm

Heat exchanger

Type	Al-Cu lamellar
Length	L-295 mm
Connection thread	2×G1/2" inner

Working conditions

Max. temperature	110 °C
Max. overpressure	1 MPa (10 bar)
Protection	IP 20
Ambient conditions	Temp. T = +2 to +40 °C Humidity Rh = 20 to 70%

Accessories per order



Variants

Grilles

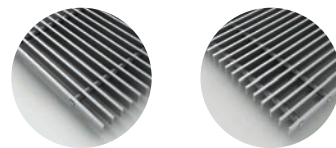

Transverse roll-up

Linear

Peripheral ledges

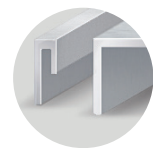

Trench heater heating output FRK 0080 0250/0300

Q[W] 75/65/20 °C (ΔT=50 °C)

H×W [mm]	0140 0175	0140 0200	0140 0250	0140 0300	0140 0350	0140 0425
L [mm]	n=1,495	n=1,496	n=1,443	n=1,453	n=1,452	n=1,403
700	111 W	116 W	200 W	223 W	276 W	354 W
800	138 W	145 W	249 W	278 W	344 W	441 W
900	165 W	174 W	298 W	333 W	412 W	528 W
1000	192 W	203 W	347 W	389 W	481 W	615 W
1100	220 W	231 W	396 W	444 W	549 W	703 W
1200	247 W	260 W	446 W	499 W	617 W	790 W
1300	274 W	289 W	495 W	554 W	685 W	877 W
1400	301 W	317 W	544 W	609 W	753 W	964 W
1500	329 W	346 W	593 W	664 W	822 W	1 052 W
1600	356 W	375 W	642 W	719 W	890 W	1 139 W
1700	383 W	404 W	692 W	774 W	958 W	1 226 W
1800	411 W	432 W	741 W	829 W	1026 W	1 314 W
1900	438 W	461 W	790 W	885 W	1094 W	1 401 W
2000	465 W	490 W	839 W	940 W	1162 W	1 488 W
2100	492 W	519 W	889 W	995 W	1231 W	1 575 W
2200	520 W	547 W	938 W	1 050 W	1299 W	1 663 W
2300	547 W	576 W	987 W	1 105 W	1367 W	1 750 W
2400	574 W	605 W	1 036 W	1 160 W	1435 W	1 837 W
2500	602 W	633 W	1 085 W	1 215 W	1503 W	1 925 W
2600	629 W	662 W	1 135 W	1 270 W	1572 W	2 012 W
2700	656 W	691 W	1 184 W	1 325 W	1640 W	2 099 W
2800	683 W	720 W	1 233 W	1 381 W	1708 W	2 186 W
2900	711 W	748 W	1 282 W	1 436 W	1776 W	2 274 W
3000	738 W	777 W	1 332 W	1 491 W	1844 W	2 361 W
3200	793 W	835 W	1 430 W	1 601 W	1981 W	2 536 W
3400	847 W	892 W	1 528 W	1 711 W	2117 W	2 710 W
3600	902 W	949 W	1 627 W	1 821 W	2253 W	2 885 W
3800	956 W	1 007 W	1 725 W	1 932 W	2390 W	3 059 W
4000	1 011 W	1 064 W	1 824 W	2 042 W	2526 W	3 234 W
4200	1 065 W	1 122 W	1 922 W	2 152 W	2662 W	3 408 W
4400	1 120 W	1 179 W	2 021 W	2 262 W	2799 W	3 583 W
4600	1 174 W	1 237 W	2 119 W	2 373 W	2935 W	3 757 W
4800	1 229 W	1 294 W	2 218 W	2 483 W	3071 W	3 932 W

Q[W] 55/45/20 °C (ΔT=30 °C)

H×W [mm]	0140 0175	0140 0200	0140 0250	0140 0300	0140 0350	0140 0425
L [mm]	n=1,495	n=1,496	n=1,443	n=1,453	n=1,452	n=1,403
700	52 W	54 W	96 W	106 W	131	173 W
800	64 W	68 W	119 W	132 W	164	215 W
900	77 W	81 W	143 W	159 W	196	258 W
1000	89 W	95 W	166 W	185 W	229	300 W
1100	103 W	108 W	189 W	211 W	261	343 W
1200	115 W	121 W	213 W	238 W	294	386 W
1300	128 W	135 W	237 W	264 W	326	428 W
1400	140 W	148 W	260 W	290 W	359	471 W
1500	153 W	161 W	284 W	316 W	392	514 W
1600	166 W	175 W	307 W	342 W	424	556 W
1700	179 W	188 W	331 W	368 W	456	599 W
1800	192 W	201 W	355 W	395 W	489	642 W
1900	204 W	215 W	378 W	421 W	521	684 W
2000	217 W	228 W	401 W	447 W	553	727 W
2100	229 W	242 W	425 W	474 W	586	769 W
2200	242 W	255 W	449 W	500 W	619	812 W
2300	255 W	268 W	472 W	526 W	651	854 W
2400	268 W	282 W	496 W	552 W	683	897 W
2500	281 W	295 W	519 W	578 W	716	940 W
2600	293 W	308 W	543 W	604 W	749	982 W
2700	306 W	322 W	567 W	631 W	781	1 025 W
2800	318 W	335 W	590 W	657 W	814	1 067 W
2900	331 W	348 W	613 W	684 W	846	1 110 W
3000	344 W	362 W	637 W	710 W	878	1 153 W
3200	370 W	389 W	684 W	762 W	944	1 238 W
3400	395 W	415 W	731 W	814 W	1008	1 323 W
3600	420 W	442 W	778 W	867 W	1073	1 409 W
3800	446 W	469 W	825 W	920 W	1138	1 494 W
4000	471 W	495 W	873 W	972 W	1203	1 579 W
4200	496 W	522 W	920 W	1 024 W	1268	1 664 W
4400	522 W	549 W	967 W	1 077 W	1333	1 749 W
4600	547 W	576 W	1 014 W	1 129 W	1398	1 834 W
4800	573 W	603 W	1 061 W	1 182 W	1463	1 920 W

75/65/20 °C → 75 °C inlet temperature, 65 °C outlet temp., 20 °C room temp. / Output 90/70/20 °C = ~ 1,29 x 75/65/20 °C / Output 70/55/20 °C = ~ 0,80 x 75/65/20 °C / Heating outputs in accordance with EN 16430 / Not listed heating output for lengths per 100 mm steps calculate linearly. Exact values can be found at www.isan.cz



FRK 0080 0300

Technical drawing

FRK 0080 0250

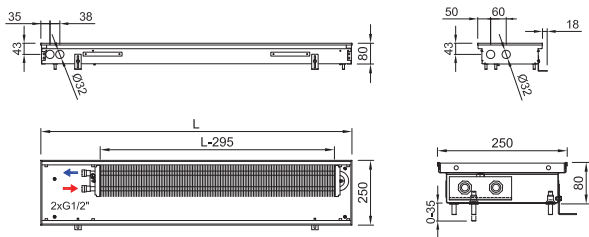

FRK 0080 0300

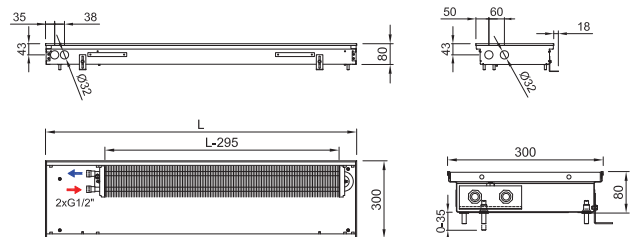

Trench heater standard equipment

Trough	Galvanized steel trough with surface finish and black spray layer inside, black cover plates of connection
Heat exchanger	Al-Cu lamellar exchanger with air vent valve, black painted
Grille	Design walkable grille according the customer's choice (stainless grilles surcharge)
Ledge	Made of anodized aluminium, type and colour according the customer's choice
Assembly elements	Leveling screws for setting up the trough, mounting brackets
Manual	Manual for the progress of work during installation and user manual
Wiring	Electrical wiring diagram of the trench heaters
Mounting board	Cover and the spacer particle board for easy installation
Package	Transport package for protection against damage during transportation and handling

Connection to heating system

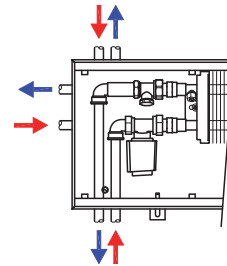

① Grilles → 6 ② Ledges → 8 ③ Accessories → 14 ④ Hydraulic parameters → 126

Code example: FRK 0080 0250 1900 C 11 L1 L - 0 / Trench heater **FRK** H=80 mm, W= 250 mm, L=1 900 mm, „C“ Galvanized steel trough with black inside, heat exchanger and inner parts painted black, „15“, Low natural anodized aluminium grille, transverse, rigid, „L1“ peripheral ledge „L“ with an overlap, natur anodized aluminium „L“ water connection at the left side (when installing the heat exchanger closer to the window, fans to the room), „0“ trench heater with natural convection

FRK 0090 175/0200/0250/0300/0350

TRENCH HEATERS WITH NATURAL CONVECTION



- › Offices, corridors, halls, flats, winter garden
- › High heating output of natural convection
- › Suitable for combining with other heating systems
- › Using in dry environment
- › 2pipe system



FRK 0090 0175



FRK 0090 0200

Technical data

Trench heater

Height [H]	90 mm
Width [W]	175, 200, 250, 300, 350, 425 mm
Length [L]	700-4 800 mm in step 100 mm

Heat exchanger

Type	Al-Cu lamellar
Length	L-295 mm
Connection thread	2×G1/2" inner

Working conditions

Max. temperature	110 °C
Max. overpressure	1 MPa (10 bar)
Protection	IP 20
Ambient conditions	Temp. T = +2 to +40 °C Humidity Rh = 20 to 70%

Accessories per order



Manual thermostat



Room thermostat with a capillary



Electrothermal actuator



Thermostatic valve



Lockshield valve

Variants

Grilles

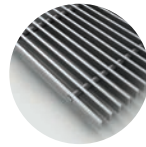

Transverse roll-up

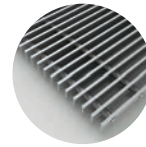

Linear

Peripheral ledges

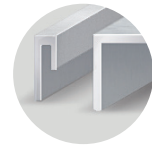

Trench heater heating output FRK 0090 0175/0200/0250/0300/0350/0425

Q[W] 75/65/20 °C (ΔT=50 °C)

H×W [mm]	0090 0175	0090 0200	0090 0250	0090 0300	0090 0350	0090 0425
L [mm]	n=1,46	n=1,463	n=1,375	n=1,369	n=1,372	n=1,389
700	79 W	94 W	137 W	146 W	168 W	209 W
800	98 W	117 W	171 W	182 W	210 W	261 W
900	118 W	140 W	205 W	218 W	252 W	313 W
1000	137 W	164 W	239 W	254 W	293 W	365 W
1100	157 W	187 W	273 W	290 W	335 W	416 W
1200	176 W	210 W	306 W	326 W	376 W	468 W
1300	196 W	233 W	340 W	362 W	418 W	520 W
1400	215 W	256 W	374 W	398 W	460 W	572 W
1500	235 W	279 W	408 W	434 W	501 W	623 W
1600	254 W	303 W	442 W	470 W	543 W	675 W
1700	274 W	326 W	476 W	506 W	584 W	727 W
1800	293 W	349 W	510 W	542 W	626 W	778 W
1900	313 W	372 W	544 W	578 W	668 W	830 W
2000	332 W	395 W	577 W	614 W	709 W	882 W
2100	352 W	419 W	611 W	650 W	751 W	934 W
2200	371 W	442 W	645 W	686 W	792 W	985 W
2300	391 W	465 W	679 W	722 W	834 W	1037 W
2400	411 W	488 W	713 W	758 W	876 W	1089 W
2500	430 W	511 W	747 W	794 W	917 W	1140 W
2600	450 W	535 W	781 W	830 W	959 W	1192 W
2700	469 W	558 W	814 W	866 W	1000 W	1244 W
2800	489 W	581 W	848 W	902 W	1042 W	1296 W
2900	508 W	604 W	882 W	938 W	1084 W	1347 W
3000	528 W	627 W	916 W	974 W	1125 W	1399 W
3200	567 W	674 W	984 W	1046 W	1208 W	1502 W
3400	606 W	720 W	1052 W	1118 W	1292 W	1606 W
3600	645 W	766 W	1119 W	1190 W	1375 W	1709 W
3800	684 W	813 W	1187 W	1262 W	1458 W	1813 W
4000	723 W	859 W	1255 W	1334 W	1541 W	1916 W
4200	762 W	906 W	1322 W	1406 W	1624 W	2020 W
4400	801 W	952 W	1390 W	1478 W	1708 W	2123 W
4600	840 W	998 W	1458 W	1550 W	1791 W	2227 W
4800	879 W	1045 W	1526 W	1622 W	1874 W	2330 W

Q[W] 55/45/20 °C (ΔT=30 °C)

H×W [mm]	0090 0175	0090 0200	0090 0250	0090 0300	0090 0350	0090 0425
L [mm]	n=1,46	n=1,463	n=1,375	n=1,369	n=1,372	n=1,389
700	37 W	45 W	68 W	73 W	83 W	103 W
800	46 W	55 W	85 W	90 W	104 W	128 W
900	56 W	66 W	102 W	108 W	125 W	154 W
1000	65 W	78 W	118 W	126 W	145 W	180 W
1100	74 W	89 W	135 W	144 W	166 W	205 W
1200	83 W	99 W	152 W	162 W	187 W	230 W
1300	93 W	110 W	168 W	180 W	207 W	256 W
1400	102 W	121 W	185 W	198 W	228 W	281 W
1500	111 W	132 W	202 W	216 W	249 W	306 W
1600	120 W	144 W	219 W	234 W	269 W	332 W
1700	130 W	154 W	236 W	251 W	290 W	358 W
1800	139 W	165 W	253 W	269 W	311 W	383 W
1900	148 W	176 W	270 W	287 W	331 W	408 W
2000	157 W	187 W	286 W	305 W	352 W	434 W
2100	167 W	198 W	303 W	323 W	373 W	459 W
2200	176 W	209 W	320 W	341 W	393 W	484 W
2300	185 W	220 W	336 W	359 W	414 W	510 W
2400	195 W	231 W	353 W	377 W	435 W	536 W
2500	204 W	242 W	370 W	395 W	455 W	561 W
2600	213 W	253 W	387 W	412 W	476 W	586 W
2700	222 W	264 W	403 W	430 W	496 W	612 W
2800	232 W	275 W	420 W	448 W	517 W	637 W
2900	241 W	286 W	437 W	466 W	538 W	662 W
3000	250 W	297 W	454 W	484 W	558 W	688 W
3200	269 W	319 W	488 W	520 W	599 W	739 W
3400	287 W	341 W	521 W	556 W	641 W	790 W
3600	306 W	363 W	554 W	591 W	682 W	841 W
3800	324 W	385 W	588 W	627 W	723 W	892 W
4000	343 W	407 W	622 W	663 W	765 W	942 W
4200	361 W	429 W	655 W	699 W	806 W	993 W
4400	380 W	451 W	689 W	734 W	847 W	1 044 W
4600	398 W	473 W	722 W	770 W	889 W	1 095 W
4800	417 W	495 W	756 W	806 W	930 W	1 146 W

75/65/20 °C → 75 °C inlet temperature, 65 °C outlet temp., 20 °C room temp. / Output 90/70/20 °C = ~ 1,29 x 75/65/20 °C / Output 70/55/20 °C = ~ 0,80 x 75/65/20 °C / Heating outputs in accordance with EN 16430 / Not listed heating output for lengths per 100 mm steps calculate linearly. Exact values can be found at www.isan.cz

/0425

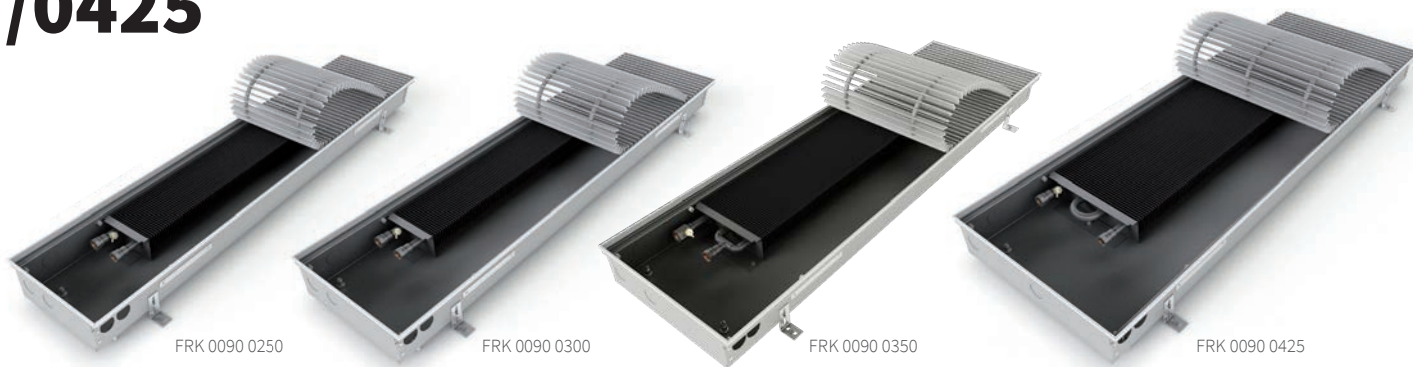

Technical drawing

FRK 0090 0175

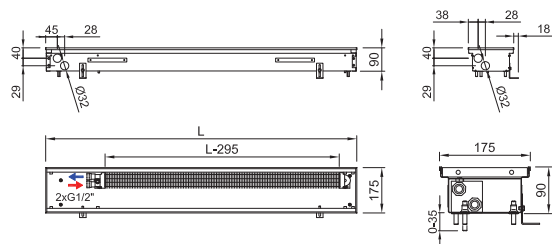

FRK 0090 0200

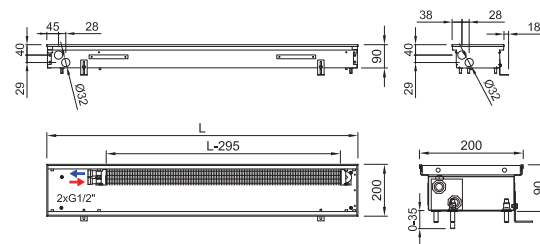

FRK 0090 0250

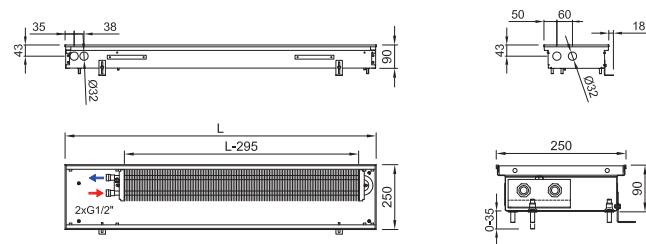

FRK 0090 0300

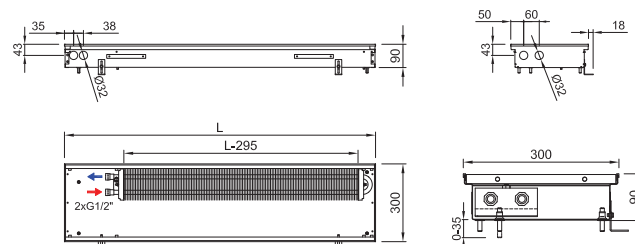

FRK 0090 0350

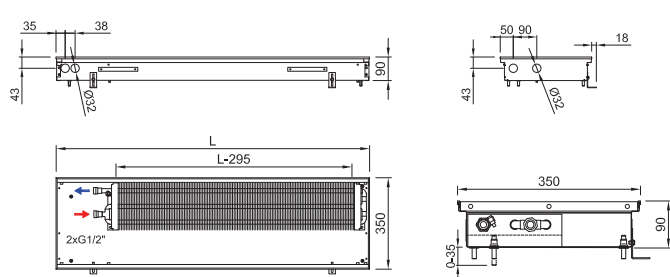

FRK 0090 0425

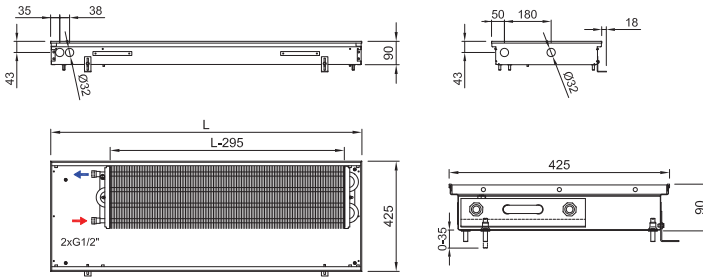

Trench heater standard equipment

- Trough** Galvanized steel trough with surface finish and black spray layer inside, black cover plates of connection
- Heat exchanger** Al-Cu lamellar exchanger with air vent valve, black painted
- Grille** Design walkable grille according the customer's choice (stainless grilles surcharge)
- Ledge** Made of anodized aluminium, type and colour according the customer's choice
- Assembly elements** Leveling screws for setting up the trough, mounting brackets
- Manual** Manual for the progress of work during installation and user manual
- Wiring** Electrical wiring diagram of the trench heaters
- Mounting board** Cover and the spacer particle board for easy installation
- Package** Transport package for protection against damage during transportation and handling

Ⓜ Grilles → 6 Ⓜ Ledges → 8 Ⓜ Accessories → 14 Ⓜ Hydraulic parameters → 126

Connection to heating system

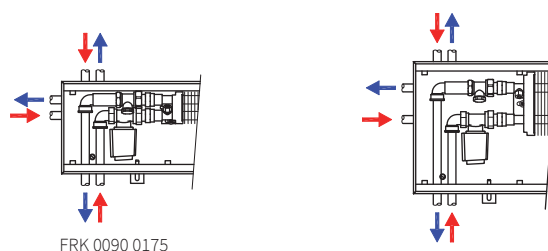

FRK 0090 0175

Code example: FRK 0090 0300 0900 C 12 J1 L - 0/ Trench heater FRK H=90 mm, W= 300 mm, L=900 mm, „C” Galvanized steel trough with black inside, heat exchanger and inner parts painted black, „12” natur anodized aluminium grille, linear, rigid „J1” peripheral ledge „J”, natur anodized aluminium, „L” water connection at the left side (when installing the heat exchanger closer to the window, fans to the room), „0” trench heater with natural convection

FRK 0110 0175/0200/0250/0300/0350

TRENCH HEATERS WITH NATURAL CONVECTION



- › Offices, corridors, halls, flats, winter garden
- › High heating output of natural convection
- › Suitable for combining with other heating systems
- › Using in dry environment
- › 2 pipe system



FRK 0110 0175



FRK 0110 0200

Technical data

Trench heater

Height [H]	110 mm
Width [W]	175, 200, 250, 300, 350, 425 mm
Length [L]	700-4 800 mm in step 100 mm

Heat exchanger

Type	Al-Cu lamellar
Length	L-295 mm
Connection thread	2×G1/2" inner

Working conditions

Max. temperature	110 °C
Max. overpressure	1 MPa (10 bar)
Protection	IP 20
Ambient conditions	Temp. T = +2 to +40 °C Humidity Rh = 20 to 70%

Accessories per order



Manual thermostat



Room thermostat with a capillary



Electrothermal actuator



Thermostatic valve



Lockshield valve

Variants

Grilles

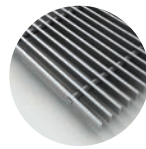

Transverse roll-up

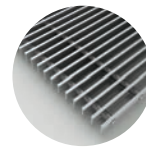

Linear

Peripheral ledges

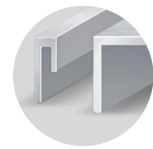

Trench heater heating output FRK 0110 0175/0200/0250/0300/0350/0425

Q[W] 75/65/20 °C (ΔT=50 °C)

H×W [mm]	0110 0175	0110 0200	0110 0250	0110 0300	0110 0350	0110 0425
L [mm]	n=1,479	n=1,479	n=1,46	n=1,468	n=1,458	n=1,403
700	103	110	166	182	194	245
800	129	137	207	227	242	305
900	155	164	248	272	290	365
1 000	180	191	289	316	338	425
1 100	206	218	330	361	386	486
1 200	232	246	371	406	434	546
1 300	257	273	413	451	482	607
1 400	283	300	454	496	530	667
1 500	308	327	495	541	578	727
1 600	334	354	536	586	625	788
1 700	359	381	577	631	673	848
1 800	385	408	618	676	721	908
1 900	411	435	659	720	769	969
2 000	436	463	700	765	817	1 029
2 100	462	490	741	810	865	1 089
2 200	487	517	782	855	913	1 150
2 300	513	544	823	900	961	1 210
2 400	539	571	864	945	1 009	1 270
2 500	564	598	905	990	1 057	1 331
2 600	590	625	946	1 035	1 105	1 391
2 700	615	653	987	1 080	1 153	1 451
2 800	641	680	1 028	1 124	1 201	1 512
2 900	667	707	1 069	1 169	1 249	1 572
3 000	692	734	1 110	1 214	1 297	1 632
3 200	743	788	1 192	1 304	1 392	1 753
3 400	794	842	1 275	1 394	1 488	1 874
3 600	846	897	1 357	1 484	1 584	1 995
3 800	897	951	1 439	1 573	1 680	2 115
4 000	948	1 005	1 521	1 663	1 776	2 236
4 200	999	1 060	1 603	1 753	1 872	2 357
4 400	1 050	1 114	1 685	1 843	1 968	2 477
4 600	1 101	1 168	1 767	1 932	2 063	2 598
4 800	1 153	1 222	1 849	2 022	2 159	2 719

Q[W] 55/45/20 °C (ΔT=30 °C)

H×W [mm]	0110 0175	0110 0200	0110 0250	0110 0300	0110 0350	0110 0425
L [mm]	n=1,479	n=1,479	n=1,46	n=1,468	n=1,458	n=1,403
700	48	52	79	86	92	120
800	61	64	98	107	115	149
900	73	77	118	129	138	178
1 000	85	90	137	149	160	208
1 100	97	102	157	171	183	237
1 200	109	116	176	192	206	267
1 300	121	128	196	213	229	297
1 400	133	141	215	234	252	326
1 500	145	154	235	256	274	355
1 600	157	166	254	277	297	385
1 700	169	179	274	298	320	414
1 800	181	192	293	319	342	444
1 900	193	204	313	340	365	473
2 000	205	217	332	361	388	503
2 100	217	230	351	383	411	532
2 200	229	243	371	404	434	562
2 300	241	256	390	425	456	591
2 400	253	268	410	446	479	620
2 500	265	281	429	468	502	650
2 600	277	294	449	489	525	679
2 700	289	307	468	510	547	709
2 800	301	319	488	531	570	739
2 900	313	332	507	552	593	768
3 000	325	345	526	574	616	797
3 200	349	370	565	616	661	856
3 400	373	395	605	659	707	915
3 600	398	421	644	701	752	975
3 800	421	447	683	743	798	1 033
4 000	445	472	721	786	843	1 092
4 200	469	498	760	828	889	1 151
4 400	493	523	799	871	934	1 210
4 600	517	549	838	913	980	1 269
4 800	542	574	877	955	1 025	1 328

75/65/20 °C → 75 °C inlet temperature, 65 °C outlet temp., 20 °C room temp. / Output 90/70/20 °C = ~ 1,29 x 75/65/20 °C / Output 70/55/20 °C = ~ 0,80 x 75/65/20 °C / Heating outputs in accordance with EN 16430 / Not listed heating output for lengths per 100 mm steps calculate linearly. Exact values can be found at www.isan.cz

/0425



Technical drawing

FRK 0110 0175

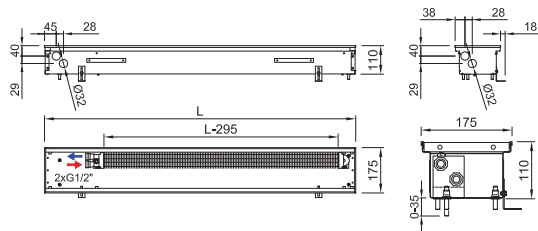

FRK 0110 0200

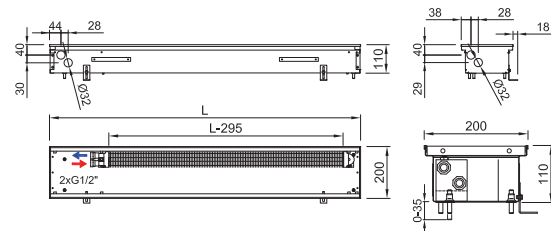

FRK 0110 0250

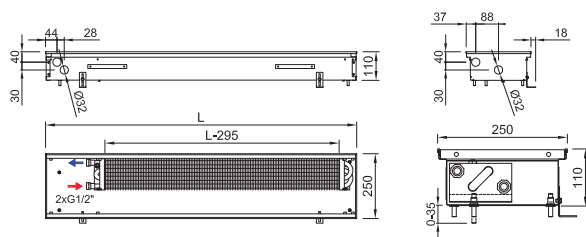

FRK 0110 0300

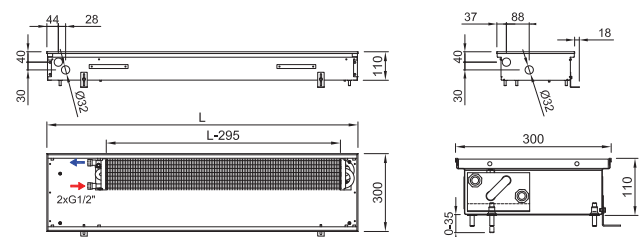

FRK 0110 0350

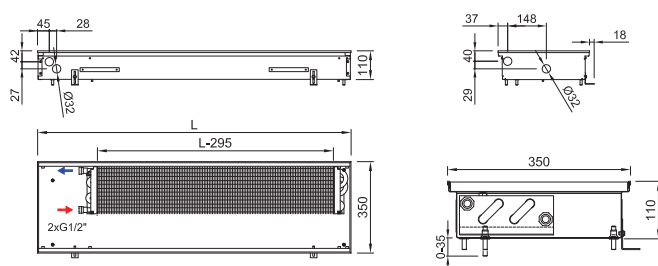

FRK 0110 0425

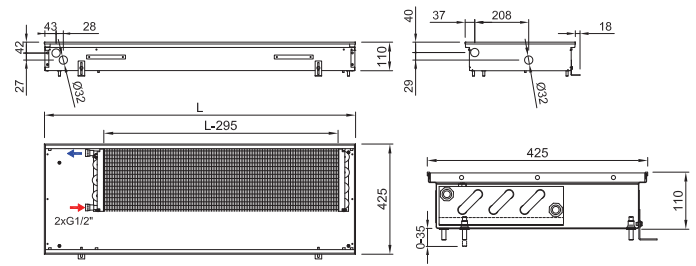

Trench heater standard equipment

- Trough** Galvanized steel trough with surface finish and black spray layer inside, black cover plates of connection
- Heat exchanger** Al-Cu lamellar exchanger with air vent valve, black painted
- Grille** Design walkable grille according the customer's choice (stainless grilles surcharge)
- Ledge** Made of anodized aluminium, type and colour according the customer's choice
- Assembly elements** Leveling screws for setting up the trough, mounting brackets
- Manual** Manual for the progress of work during installation and user manual
- Wiring** Electrical wiring diagram of the trench heaters
- Mounting board** Cover and the spacer particle board for easy installation
- Package** Transport package for protection against damage during transportation and handling

- Ⓜ Grilles → 6
- Ⓛ Ledges → 8
- ⊕ Accessories → 14
- Ⓞ Hydraulic parameters → 126

Connection to heating system

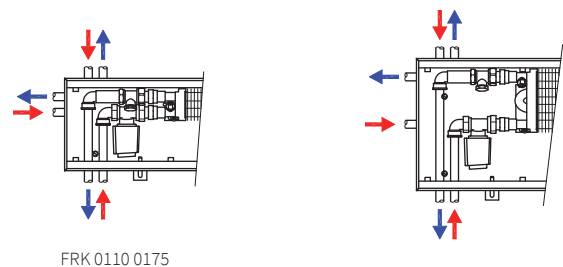

Code example: FRK 0110 0175 2200 C 21 J2 R - 0 / Trench heater **FRK** H=110 mm, W=175 mm, L=2 200 mm, „C” Galvanized steel trough with black inside, heat exchanger and inner parts painted black, „21” bronze anodized aluminium grille, transverse, roll-up, „J2” peripheral ledge „J”, bronze anodized aluminium, „R” water connection at the right side (when installing the heat exchanger closer to the window, fans to the room), „0” trench heater with natural convection

FRK 0125 175/0200/0250/0300/0350

TRENCH HEATERS WITH NATURAL CONVECTION



- › Offices, corridors, halls, flats, winter garden
- › High heating output of natural convection
- › Suitable for combining with other heating systems
- › Using in dry environment
- › 2pipe system



FRK 0125 0175



FRK 0125 0200

Technical data

Trench heater

Height [H]	125 mm
Width [W]	175, 200, 250, 300, 350, 425 mm
Length [L]	700-4 800 mm in step 100 mm

Heat exchanger

Type	Al-Cu lamellar
Length	L-295 mm
Connection thread	2×G1/2" inner

Working conditions

Max. temperature	110 °C
Max. overpressure	1 MPa (10 bar)
Protection	IP 20
Ambient conditions	Temp. T = +2 to +40 °C Humidity Rh = 20 to 70%

Accessories per order



Manual thermostat



Room thermostat with a capillary



Electrothermal actuator



Thermostatic valve



Lockshield valve

Variants

Grilles

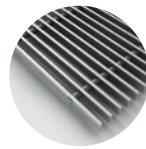

Transverse roll-up

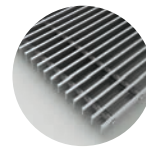

Linear

Peripheral ledges

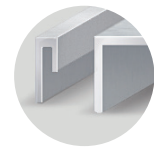

Trench heater heating output FRK 0125 0175/0200/0250/0300/0350/0425

Q[W] 75/65/20 °C (ΔT=50 °C)

H×W [mm] L [mm]	0125 0175 n=1,483	0125 0200 n=1,485	0125 0250 n=1,457	0125 0300 n=1,369	0125 0350 n=1,421	0125 0425 n=1,403
700	107	112	188	213	266	319
800	134	140	235	266	332	398
900	161	168	281	319	398	477
1 000	187	196	328	372	464	556
1 100	214	224	374	424	530	635
1 200	240	251	421	477	596	714
1 300	267	279	467	530	661	793
1 400	293	307	514	583	727	872
1 500	320	335	560	635	793	951
1 600	346	363	607	688	859	1 030
1 700	373	390	653	741	925	1 109
1 800	399	418	700	793	990	1 187
1 900	426	446	746	846	1 056	1 266
2 000	452	474	793	899	1 122	1 345
2 100	479	501	839	952	1 188	1 424
2 200	505	529	886	1 004	1 254	1 503
2 300	532	557	932	1 057	1 320	1 582
2 400	559	585	978	1 110	1 385	1 661
2 500	585	613	1 025	1 162	1 451	1 740
2 600	612	640	1 071	1 215	1 517	1 819
2 700	638	668	1 118	1 268	1 583	1 898
2 800	665	696	1 164	1 321	1 649	1 977
2 900	691	724	1 211	1 373	1 714	2 055
3 000	718	751	1 257	1 426	1 780	2 134
3 200	771	807	1 350	1 531	1 912	2 292
3 400	824	863	1 443	1 637	2 043	2 450
3 600	877	918	1 536	1 742	2 175	2 608
3 800	930	974	1 629	1 848	2 307	2 766
4 000	983	1 029	1 722	1 953	2 438	2 923
4 200	1 036	1 085	1 815	2 059	2 570	3 081
4 400	1 089	1 140	1 908	2 164	2 702	3 239
4 600	1 142	1 196	2 001	2 270	2 833	3 397
4 800	1 195	1 252	2 094	2 375	2 965	3 555

Q[W] 55/45/20 °C (ΔT=30 °C)

H×W [mm] L [mm]	0125 0175 n=1,483	0125 0200 n=1,485	0125 0250 n=1,457	0125 0300 n=1,369	0125 0350 n=1,421	0125 0425 n=1,403
700	50	52	89	106	129	156
800	63	66	112	132	161	194
900	75	79	134	159	193	233
1 000	88	92	156	185	225	272
1 100	100	105	178	211	256	310
1 200	112	118	200	237	288	349
1 300	125	131	222	263	320	387
1 400	137	144	244	290	352	426
1 500	150	157	266	316	384	464
1 600	162	170	288	342	416	503
1 700	175	183	310	368	448	542
1 800	187	196	333	394	479	580
1 900	200	209	354	420	511	618
2 000	212	222	377	447	543	657
2 100	225	235	399	473	575	695
2 200	237	248	421	499	607	734
2 300	249	261	443	525	639	773
2 400	262	274	465	552	670	811
2 500	274	287	487	577	702	850
2 600	287	300	509	604	734	888
2 700	299	313	531	630	766	927
2 800	312	326	553	656	798	966
2 900	324	339	575	682	829	1 004
3 000	337	352	597	709	861	1 042
3 200	361	378	641	761	925	1 119
3 400	386	404	686	814	989	1 197
3 600	411	430	730	866	1 052	1 274
3 800	436	456	774	918	1 116	1 351
4 000	461	482	818	971	1 180	1 428
4 200	486	508	862	1 023	1 244	1 505
4 400	510	534	907	1 075	1 307	1 582
4 600	535	560	951	1 128	1 371	1 659
4 800	560	586	995	1 180	1 435	1 736

75/65/20 °C → 75 °C inlet temperature, 65 °C outlet temp., 20 °C room temp. / Output 90/70/20 °C = ~ 1,29 x 75/65/20 °C / Output 70/55/20 °C = ~ 0,80 x 75/65/20 °C / Heating outputs in accordance with EN 16430 / Not listed heating output for lengths per 100 mm steps calculate linearly. Exact values can be found at www.isan.cz

/0425



Technical drawing

FRK 0125 0175

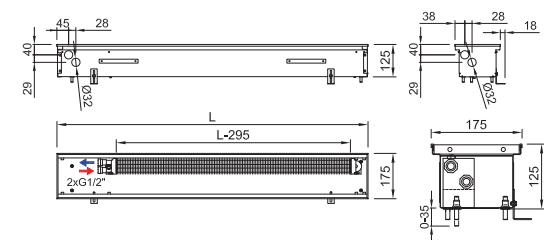

FRK 0125 0200

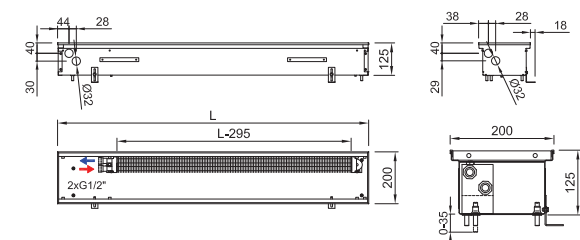

FRK 0125 0250

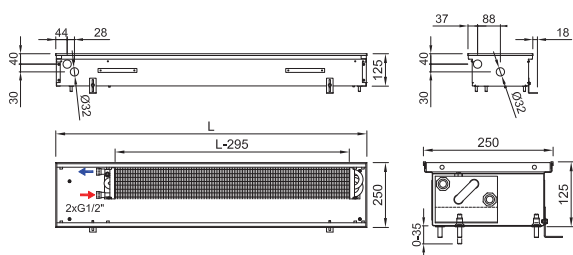

FRK 0125 0300

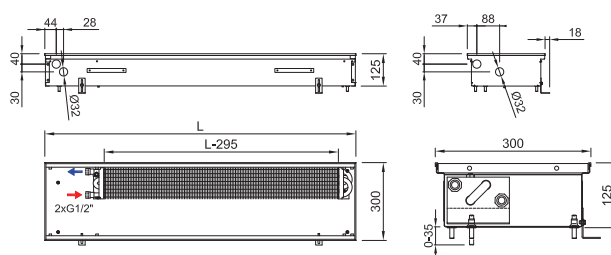

FRK 0125 0350

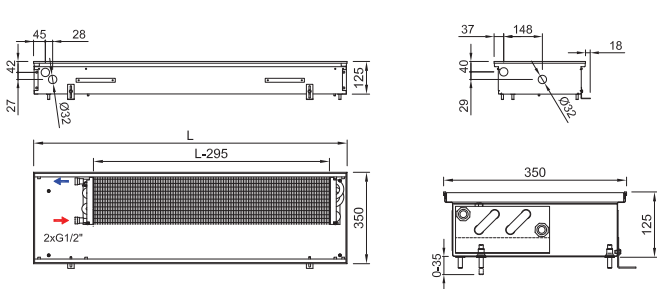

FRK 0125 0425

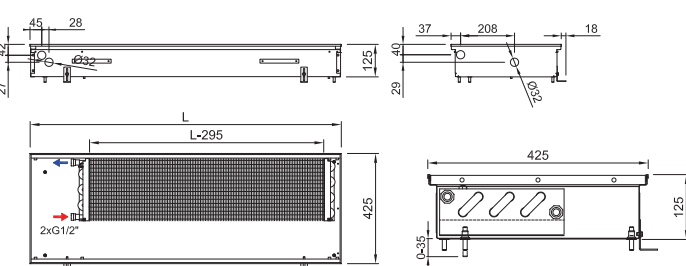

Trench heater standard equipment

- Trough** Galvanized steel trough with surface finish and black spray layer inside, black cover plates of connection
- Heat exchanger** Al-Cu lamellar exchanger with air vent valve, black painted
- Grille** Design walkable grille according to the customer's choice (stainless grilles surcharge)
- Ledge** Made of anodized aluminium, type and colour according to the customer's choice
- Assembly elements** Leveling screws for setting up the trough, mounting brackets
- Manual** Manual for the progress of work during installation and user manual
- Wiring** Electrical wiring diagram of the trench heaters
- Mounting board** Cover and the spacer particle board for easy installation
- Package** Transport package for protection against damage during transportation and handling

- Ⓜ Grilles → 6
- Ⓛ Ledges → 8
- ⊕ Accessories → 14
- Ⓞ Hydraulic parameters → 126

Connection to heating system

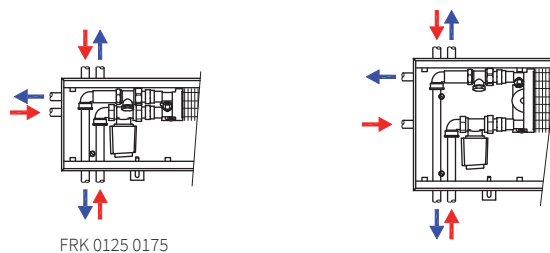

FRK 0125 0175

Code example: FRK 0125 0250 1500 C 62 L2 L - 0 / Trench heater FRK H=125 mm, W=250 mm, L=1 500 mm, „C“ Galvanized steel trough with black inside, heat exchanger and inner parts painted black, „62“ stained beech grille, transverse, roll-up, „L2“ peripheral ledge „L“ with an overlap, bronze anodized aluminium, „L“ water connection at the left side (when installing the heat exchanger closer to the window, fans to the room), „0“ trench heater with natural convection

FRK 0140 0175/0200/0250/0300/0350

TRENCH HEATERS WITH NATURAL CONVECTION



- › Offices, corridors, halls, flats, winter garden
- › High heating output of natural convection
- › Suitable for combining with other heating systems
- › Using in dry environment
- › 2pipe system



FRK 0140 0175



FRK 0140 0200

Technical data

Trench heater

Height [H]	140 mm
Width [W]	175, 200, 250, 300, 350, 425 mm
Length [L]	L = 700–4 800 mm in step 100 mm

Heat exchanger

Type	Al-Cu lamellar
Length	L-295 mm
Connection thread	2×G1/2" inner

Working conditions

Max. temperature	110 °C
Max. overpressure	1 MPa (10 bar)
Protection	IP 20
Ambient conditions	Temp. T = +2 to +40 °C Humidity Rh = 20 to 70%

Accessories per order



Manual thermostat



Room thermostat with a capillary



Electrothermal actuator



Thermostatic valve



Lockshield valve

Variants

Grilles

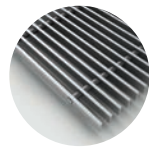

Transverse roll-up

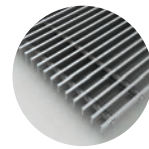

Linear

Peripheral ledges

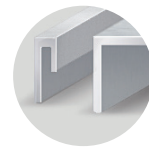

Trench heater heating output FRK 0140 0175/0200/0250/0300/0350/0425

Q[W] 75/65/20 °C (ΔT=50 °C)

H×W [mm] L [mm]	0140 0175 n=1,495	0140 0200 n=1,496	0140 0250 n=1,443	0140 0300 n=1,453	0140 0350 n=1,452	0140 0425 n=1,403
700	111	116	200	223	276	354
800	138	145	249	278	344	441
900	165	174	298	333	412	528
1 000	192	203	347	389	481	615
1 100	220	231	396	444	549	703
1 200	247	260	446	499	617	790
1 300	274	289	495	554	685	877
1 400	301	317	544	609	753	964
1 500	329	346	593	664	822	1 052
1 600	356	375	642	719	890	1 139
1 700	383	404	692	774	958	1 226
1 800	411	432	741	829	1 026	1 314
1 900	438	461	790	885	1 094	1 401
2 000	465	490	839	940	1 162	1 488
2 100	492	519	889	995	1 231	1 575
2 200	520	547	938	1 050	1 299	1 663
2 300	547	576	987	1 105	1 367	1 750
2 400	574	605	1 036	1 160	1 435	1 837
2 500	602	633	1 085	1 215	1 503	1 925
2 600	629	662	1 135	1 270	1 572	2 012
2 700	656	691	1 184	1 325	1 640	2 099
2 800	683	720	1 233	1 381	1 708	2 186
2 900	711	748	1 282	1 436	1 776	2 274
3 000	738	777	1 332	1 491	1 844	2 361
3 200	793	835	1 430	1 601	1 981	2 536
3 400	847	892	1 528	1 711	2 117	2 710
3 600	902	949	1 627	1 821	2 253	2 885
3 800	956	1 007	1 725	1 932	2 390	3 059
4 000	1 011	1 064	1 824	2 042	2 526	3 234
4 200	1 065	1 122	1 922	2 152	2 662	3 408
4 400	1 120	1 179	2 021	2 262	2 799	3 583
4 600	1 174	1 237	2 119	2 373	2 935	3 757
4 800	1 229	1 294	2 218	2 483	3 071	3 932

Q[W] 55/45/20 °C (ΔT=30 °C)

H×W [mm] L [mm]	0140 0175 n=1,495	0140 0200 n=1,496	0140 0250 n=1,443	0140 0300 n=1,453	0140 0350 n=1,452	0140 0425 n=1,403
700	52	54	96	106	131	173
800	64	68	119	132	164	215
900	77	81	143	159	196	258
1 000	89	95	166	185	229	300
1 100	103	108	189	211	261	343
1 200	115	121	213	238	294	386
1 300	128	135	237	264	326	428
1 400	140	148	260	290	359	471
1 500	153	161	284	316	392	514
1 600	166	175	307	342	424	556
1 700	179	188	331	368	456	599
1 800	192	201	355	395	489	642
1 900	204	215	378	421	521	684
2 000	217	228	401	447	553	727
2 100	229	242	425	474	586	769
2 200	242	255	449	500	619	812
2 300	255	268	472	526	651	854
2 400	268	282	496	552	683	897
2 500	281	295	519	578	716	940
2 600	293	308	543	604	749	982
2 700	306	322	567	631	781	1 025
2 800	318	335	590	657	814	1 067
2 900	331	348	613	684	846	1 110
3 000	344	362	637	710	878	1 153
3 200	370	389	684	762	944	1 238
3 400	395	415	731	814	1 008	1 323
3 600	420	442	778	867	1 073	1 409
3 800	446	469	825	920	1 138	1 494
4 000	471	495	873	972	1 203	1 579
4 200	496	522	920	1 024	1 268	1 664
4 400	522	549	967	1 077	1 333	1 749
4 600	547	576	1 014	1 129	1 398	1 834
4 800	573	603	1 061	1 182	1 463	1 920

75/65/20 °C → 75 °C inlet temperature, 65 °C outlet temp., 20 °C room temp. / Output 90/70/20 °C = ~1,29 x 75/65/20 °C / Output 70/55/20 °C = ~0,80 x 75/65/20 °C / Heating outputs in accordance with EN 16430 / Not listed heating output for lengths per 100 mm steps calculate linearly. Exact values can be found at www.isan.cz

/0425



Technical drawing

FRK 0140 0175

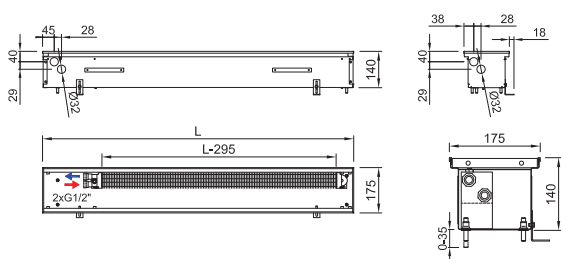

FRK 0140 0200

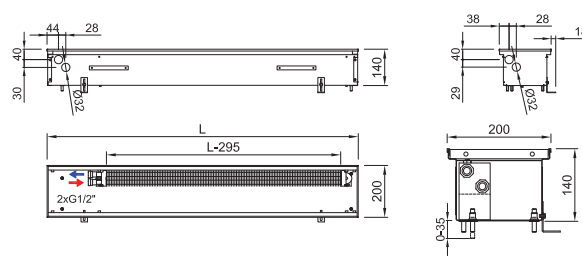

FRK 0140 0250

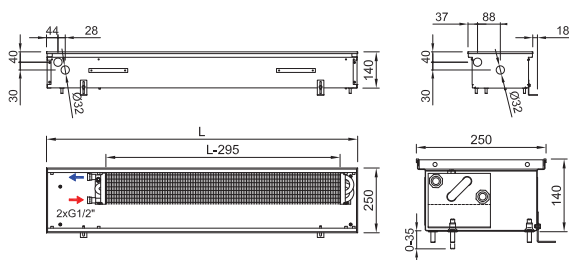

FRK 0140 0300

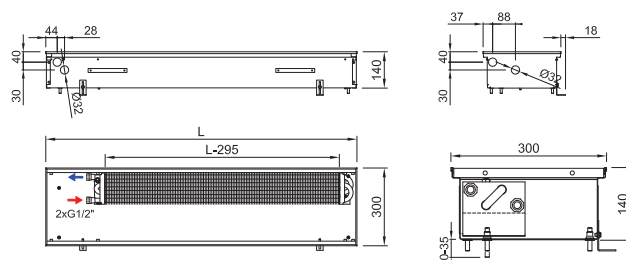

FRK 0140 0350

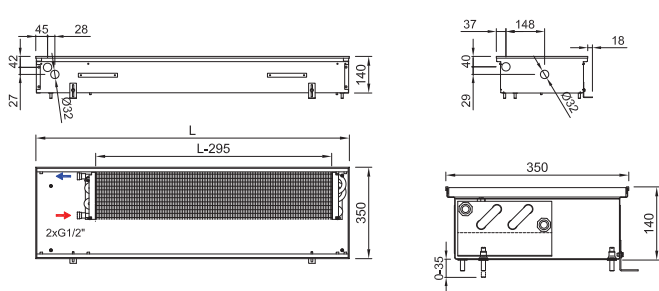

FRK 0140 0425

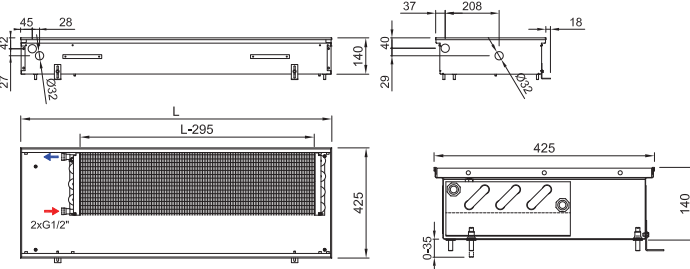

Trench heater standard equipment

- Trough** Galvanized steel trough with surface finish and black spray layer inside, black cover plates of connection
- Heat exchanger** Al-Cu lamellar exchanger with air vent valve, black painted
- Grille** Design walkable grille according the customer's choice (stainless grilles surcharge)
- Ledge** Made of anodized aluminium, type and colour according the customer's choice
- Assembly elements** Leveling screws for setting up the trough, mounting brackets
- Manual** Manual for the progress of work during installation and user manual
- Wiring** Electrical wiring diagram of the trench heaters
- Mounting board** Cover and the spacer particle board for easy installation
- Package** Transport package for protection against damage during transportation and handling

- Ⓜ Grilles → 6
- Ⓛ Ledges → 8
- ⊕ Accessories → 14
- Ⓞ Hydraulic parameters → 126

Connection to heating system

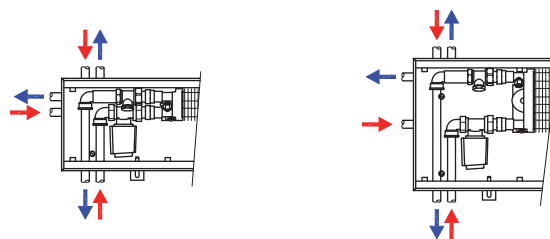

FRK 0140 0175

Code example: FRK 0140 0425 1400 C 63 L1 L - 0 / Trench heater FRK H=140 mm, W=425 mm, L= 1 400 mm, „C“ Galvanized steel trough with black inside, heat exchanger and inner parts painted black, „63“ natural oak grille, transverse, roll-up, „L1“ peripheral ledge „L“ with an overlap, natur anodized aluminium „L“ water connection at the left side (when installing the heat exchanger closer to the window, fans to the room), „0“ trench heater with natural convection

FRK 0165 0300/0350/0425

TRENCH HEATERS WITH NATURAL CONVECTION



- › Offices, corridors, halls, flats, winter garden
- › High heating output of natural convection
- › Suitable for combining with other heating systems
- › Using in dry environment
- › 2pipe system



FRK 0165 0300

Technical data

Trench heater

Height [H]	165 mm
Width [W]	300, 350, 425 mm
Length [L]	700-4800 mm in step 100 mm

Heat exchanger

Type	Al-Cu lamellar
Length	L-295 mm
Connection thread	2×G1/2" inner

Working conditions

Max. temperature	110 °C
Max. overpressure	1 MPa (10 bar)
Protection	IP 20
Ambient conditions	Temp. T = +2 to +40 °C Humidity Rh = 20 to 70%

Accessories per order



Manual thermostat



Room thermostat with a capillary



Electrothermal actuator



Thermostatic valve



Lockshield valve

Variants

Grilles

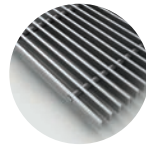

Transverse roll-up

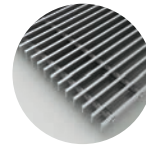

Linear

Peripheral ledges

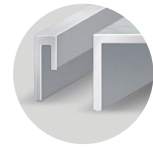

☺☺☺ Trench heater heating output FRK 0165 0300/0350/0425

Q[W] 75/65/20 °C (ΔT=50 °C)

H×W [mm] L [mm]	0165 0300 n=1,457	0165 0350 n=1,449	0165 0425 n=1,442
700	233	292	401
800	291	365	500
900	349	437	599
1 000	406	509	698
1 100	464	581	797
1 200	521	654	896
1 300	579	726	995
1 400	637	798	1 094
1 500	694	870	1 193
1 600	752	942	1 292
1 700	809	1 015	1 391
1 800	867	1 087	1 490
1 900	925	1 159	1 589
2 000	982	1 231	1 688
2 100	1 040	1 304	1 787
2 200	1 097	1 376	1 886
2 300	1 155	1 448	1 985
2 400	1 213	1 520	2 084
2 500	1 270	1 592	2 183
2 600	1 328	1 665	2 282
2 700	1 385	1 737	2 381
2 800	1 443	1 809	2 480
2 900	1 501	1 881	2 579
3 000	1 558	1 954	2 678
3 200	1 673	2 098	2 876
3 400	1 789	2 242	3 074
3 600	1 904	2 387	3 272
3 800	2 019	2 531	3 470
4 000	2 134	2 676	3 668
4 200	2 250	2 820	3 866
4 400	2 365	2 965	4 064
4 600	2 480	3 109	4 262
4 800	2 595	3 253	4 460

Q[W] 55/45/20 °C (ΔT=30 °C)

H×W [mm] L [mm]	0165 0300 n=1,457	0165 0350 n=1,449	0165 0425 n=1,442
700	111	139	192
800	138	174	239
900	166	208	287
1 000	193	243	334
1 100	220	277	382
1 200	248	312	429
1 300	275	346	476
1 400	303	381	524
1 500	330	415	571
1 600	357	449	619
1 700	384	484	666
1 800	412	519	713
1 900	440	553	761
2 000	467	587	808
2 100	494	622	856
2 200	521	656	903
2 300	549	691	950
2 400	576	725	998
2 500	603	759	1 045
2 600	631	794	1 093
2 700	658	829	1 140
2 800	686	863	1 187
2 900	713	897	1 235
3 000	740	932	1 282
3 200	795	1 001	1 377
3 400	850	1 069	1 472
3 600	905	1 139	1 567
3 800	959	1 207	1 661
4 000	1 014	1 277	1 756
4 200	1 069	1 345	1 851
4 400	1 124	1 414	1 946
4 600	1 178	1 483	2 041
4 800	1 233	1 552	2 135

75/65/20 °C → 75 °C inlet temperature, 65 °C outlet temp., 20 °C room temp. / Output 90/70/20 °C = ~ 1,29 x 75/65/20 °C / Output 70/55/20 °C = ~ 0,80 x 75/65/20 °C / Heating outputs in accordance with EN 16430 / Not listed heating output for lengths per 100 mm steps calculate linearly. Exact values can be found at www.isan.cz



FRK 0165 0350

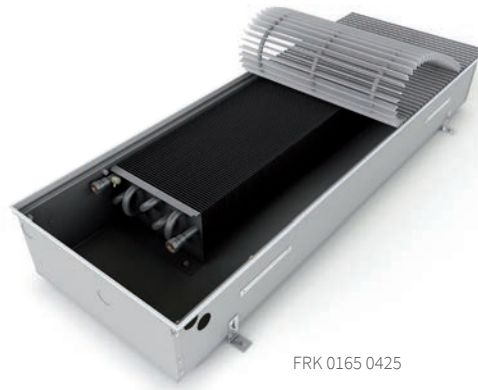

FRK 0165 0425

Technical drawing

FRK 0165 0300

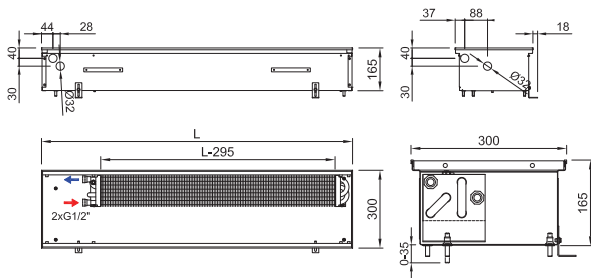

FRK 0165 0350

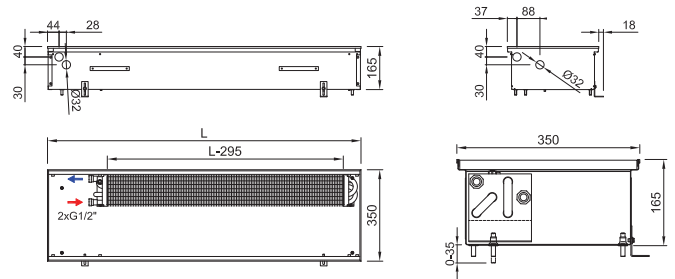

FRK 0165 0425

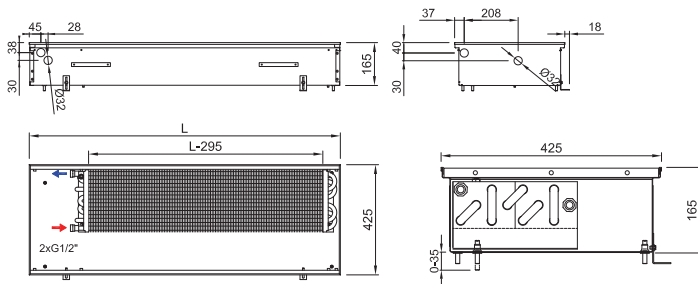

Trench heater standard equipment

Trough	Galvanized steel trough with surface finish and black spray layer inside, black cover plates of connection
Heat exchanger	Al-Cu lamellar exchanger with air vent valve, black painted
Grille	Design walkable grille according the customer's choice (stainless grilles surcharge)
Ledge	Made of anodized aluminium, type and colour according the customer's choice
Assembly elements	Leveling screws for setting up the trough, mounting brackets
Manual	Manual for the progress of work during installation and user manual
Wiring	Electrical wiring diagram of the trench heaters
Mounting board	Cover and the spacer particle board for easy installation
Package	Transport package for protection against damage during transportation and handling

Connection to heating system

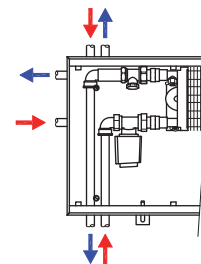

- ⓘ Grilles → 6
- Ⓛ Ledges → 8
- ⊕ Accessories → 14
- Ⓞ Hydraulic parameters → 126

Code example: FRK 0165 0300 1900 C 52 J1 R - 0 / Trench heater FRK H=165 mm, W= 300 mm, L= 1900 mm, „C“ Galvanized steel trough with black inside, heat exchanger and inner parts painted black, „52“ stainless grille, transverse, roll-up, „J1“ peripheral ledge „J“, natur anodized aluminium, „R“ water connection at the right side (when installing the heat exchanger closer to the window, fans to the room), „0“ trench heater with natural convection

FRK 0200 0300/0350/0425

TRENCH HEATERS WITH NATURAL CONVECTION



- › Offices, corridors, halls, flats, winter garden
- › High heating output of natural convection
- › Suitable for combining with other heating systems
- › Using in dry environment
- › 2pipe system



FRK 0200 0300

Technical data

Trench heater

Height [H]	200 mm
Width [W]	300, 350, 425 mm
Length [L]	700-4800 mm in step 100 mm

Heat exchanger

Type	Al-Cu lamellar
Length	L-295 mm
Connection thread	2×G1/2" inner

Working conditions

Max. temperature	110 °C
Max. overpressure	1 MPa (10 bar)
Protection	IP 20
Ambient conditions	Temp. T = +2 to +40 °C Humidity Rh = 20 to 70%

Accessories per order



Manual thermostat



Room thermostat with a capillary



Electrothermal actuator



Thermostatic valve



Lockshield valve

Variants

Grilles

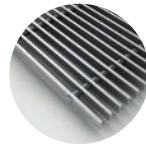

Transverse roll-up

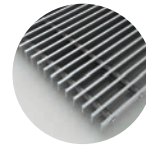

Linear

Peripheral ledges

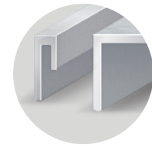

Trench heater heating output FRK 0200 0300/0350/0425

Q[W] 75/65/20 °C (ΔT=50 °C)

H×W [mm] L [mm]	0200 0300 n=1,462	0200 0350 n=1,457	0200 0425 n=1,461
700	237	319	435
800	296	397	542
900	354	476	649
1 000	413	554	756
1 100	471	633	864
1 200	530	711	971
1 300	588	790	1 078
1 400	647	869	1 185
1 500	706	947	1 293
1 600	764	1 026	1 400
1 700	823	1 104	1 507
1 800	881	1 183	1 615
1 900	940	1 262	1 722
2 000	998	1 340	1 829
2 100	1 057	1 419	1 936
2 200	1 115	1 497	2 044
2 300	1 174	1 576	2 151
2 400	1 233	1 655	2 258
2 500	1 291	1 733	2 366
2 600	1 350	1 812	2 473
2 700	1 408	1 890	2 580
2 800	1 467	1 969	2 687
2 900	1 525	2 048	2 795
3 000	1 584	2 126	2 902
3 200	1 701	2 283	3 117
3 400	1 818	2 441	3 331
3 600	1 935	2 598	3 546
3 800	2 052	2 755	3 760
4 000	2 169	2 912	3 975
4 200	2 287	3 069	4 189
4 400	2 404	3 227	4 404
4 600	2 521	3 384	4 618
4 800	2 638	3 541	4 833

Q[W] 55/45/20 °C (ΔT=30 °C)

H×W [mm] L [mm]	0200 0300 n=1,462	0200 0350 n=1,457	0200 0425 n=1,461
700	112	152	206
800	140	189	257
900	168	226	308
1 000	196	263	358
1 100	223	301	410
1 200	251	338	460
1 300	279	375	511
1 400	307	413	562
1 500	335	450	613
1 600	362	487	664
1 700	390	524	715
1 800	417	562	766
1 900	445	600	816
2 000	473	637	867
2 100	501	674	918
2 200	528	711	969
2 300	556	749	1 020
2 400	584	786	1 071
2 500	612	823	1 122
2 600	640	861	1 173
2 700	667	898	1 223
2 800	695	935	1 274
2 900	723	973	1 325
3 000	751	1 010	1 376
3 200	806	1 085	1 478
3 400	861	1 160	1 579
3 600	917	1 234	1 681
3 800	972	1 309	1 783
4 000	1 028	1 383	1 885
4 200	1 084	1 458	1 986
4 400	1 139	1 533	2 088
4 600	1 194	1 608	2 190
4 800	1 250	1 682	2 291

75/65/20 °C → 75 °C inlet temperature, 65 °C outlet temp., 20 °C room temp. / Output 90/70/20 °C = ~ 1,29 x 75/65/20 °C / Output 70/55/20 °C = ~ 0,80 x 75/65/20 °C / Heating outputs in accordance with EN 16430 / Not listed heating output for lengths per 100 mm steps calculate linearly. Exact values can be found at www.isan.cz



FRK 0200 0350



FRK 0200 0425

Technical drawing

FRK 0200 0300

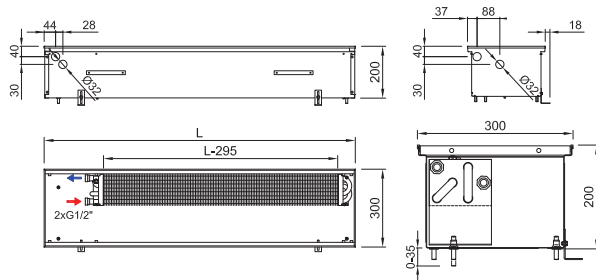

FRK 0200 0350

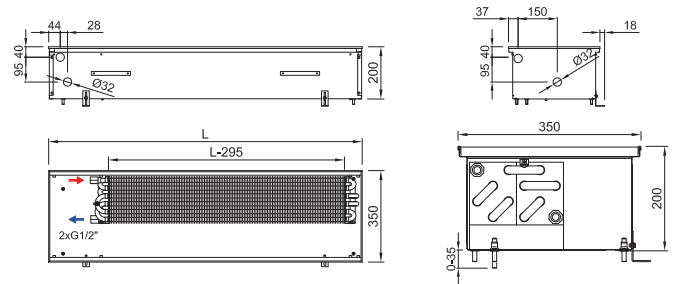

FRK 0200 0425

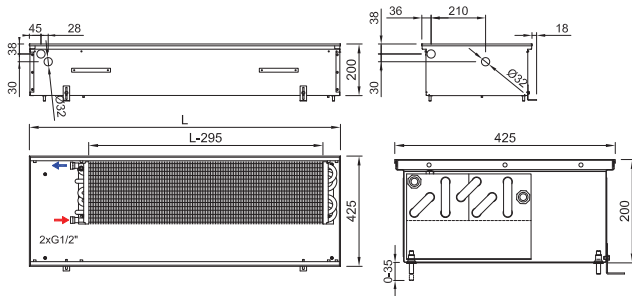

Trench heater standard equipment

Trough	Galvanized steel trough with surface finish and black spray layer inside, black cover plates of connection
Heat exchanger	Al-Cu lamellar exchanger with air vent valve, black painted
Grille	Design walkable grille according the customer's choice (stainless grilles surcharge)
Ledge	Made of anodized aluminium, type and colour according the customer's choice
Assembly elements	Leveling screws for setting up the trough, mounting brackets
Manual	Manual for the progress of work during installation and user manual
Wiring	Electrical wiring diagram of the trench heaters
Mounting board	Cover and the spacer particle board for easy installation
Package	Transport package for protection against damage during transportation and handling

Connection to heating system

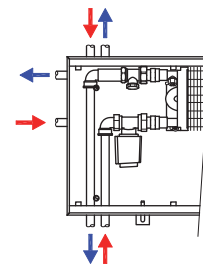

ⓘ Grilles → 6 ⓘ Ledges → 8 ⓘ Accessories → 14 ⓘ Hydraulic parameters → 126

Code example: FRK 0200 0425 1500 C 62 L2 L - 0 / Trench heater FRK H=200 mm, W= 425 mm, L= 1 500 mm, „C” Galvanized steel trough with black inside, heat exchanger and inner parts painted black, „62” stained beech grille, transverse, roll-up, „L2” peripheral ledge „L” with an overlap, bronze anodized aluminium, „L” water connection at the left side (when installing the heat exchanger closer to the window, fans to the room), „0” trench heater with natural convection

FRM

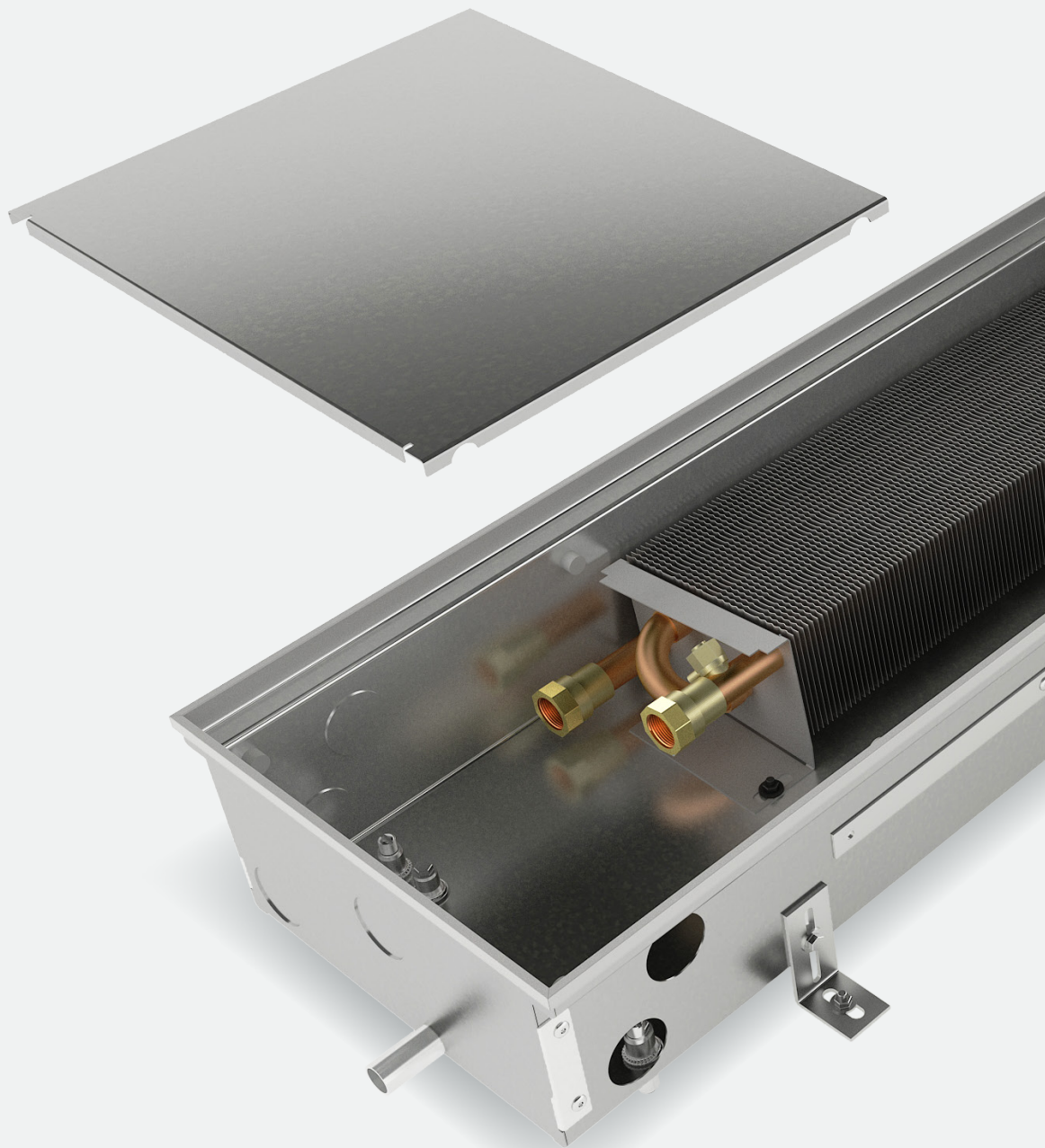

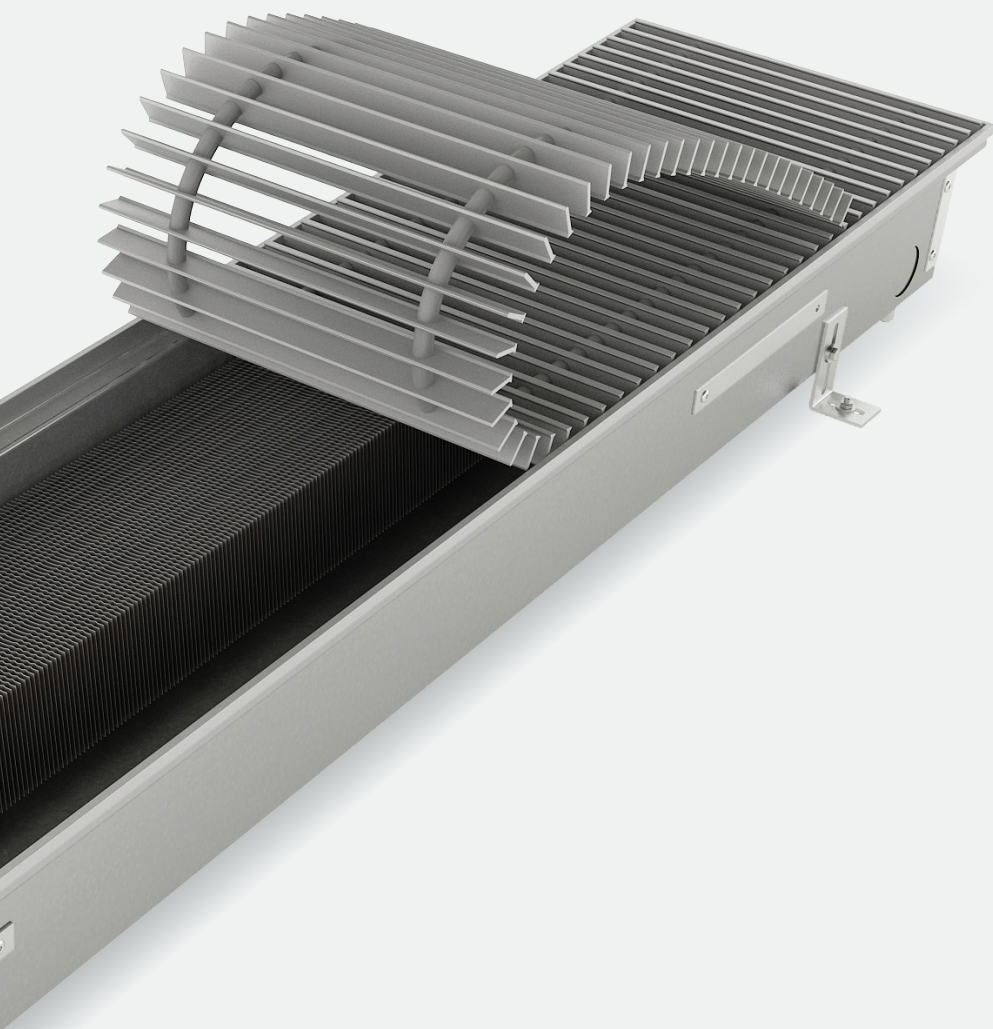

Trench heaters with **natural convection and lamellar exchanger, humid environment, heating**

TERMO - FRM

Heaters with natural convection for a humid environment



Advantages

- › Conservatories, greenhouses, bathrooms, saunas
- › Garage, warehouses, halls, stadiums
- › Pools, no submersion in water
- › High heater output
- › Suitable combination with other types of heating
- › Humid environment
- › 2 pipe system
- › Length **700-4 800 mm** (in step 100 mm)



FRM trench heaters are constructed to be used in conditions with higher moisture and possible water condensation. The heater structure is made of stainless steel resistant even to an aggressive environment and fitted with small drainage tubes along its sides.

FRM trench heaters are suitable for installation in swimming pool environments (except for salt water pools). The heaters may come in contact with pool water but must not be fully submerged. The heating unit must be placed at a sufficient distance from the pool to prevent permanent flooding.

The range of FRM models with natural convection for a humid environment

Height	80 mm	90 mm	110 mm	125 mm	140 mm	165 mm	200 mm
Width	-	175 mm	175 mm	175 mm	175 mm	-	-
	-	200 mm	200 mm	200 mm	200 mm	-	-
	250 mm	250 mm	250 mm	250 mm	250 mm	-	-
	300 mm	300 mm	300 mm	300 mm	300 mm	300 mm	300 mm
	-	350 mm	350 mm	350 mm	350 mm	350 mm	350 mm
	-	425 mm	425 mm	425 mm	425 mm	425 mm	425 mm

Trench heater standard equipment

Trough	Trough of stainless steel DIN 1,4404, unpainted
Heat exchanger	Al-Cu lamellar exchanger with air vent valve, unpainted
Grille	Design walkable grille according the customer's choice (stainless grilles surcharge); wooden grilles must be provided with appropriate surface finish
Ledge	Made of anodized aluminium, type and colour according the customer's choice
Fan	Fans 24 V DC with EC motors with higher protection grade, suitable for humid environments
Assembly elements	Leveling screws for setting up the trough, mounting brackets
Manual	Manual for the progress of work during installation and user manual
Wiring	Electrical wiring diagram of the trench heaters
Mounting board	Cover and the spacer particle board for easy installation
Package	Transport package for protection against damage during transportation and handling

Accessories per order



Grilles

Non-corroding metal grilles are most frequently used in a damp environment. If a wooden grille is chosen, its surface must be treated accordingly.

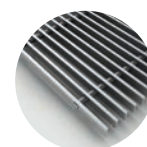

FRM an overview of trench heaters with natural convection

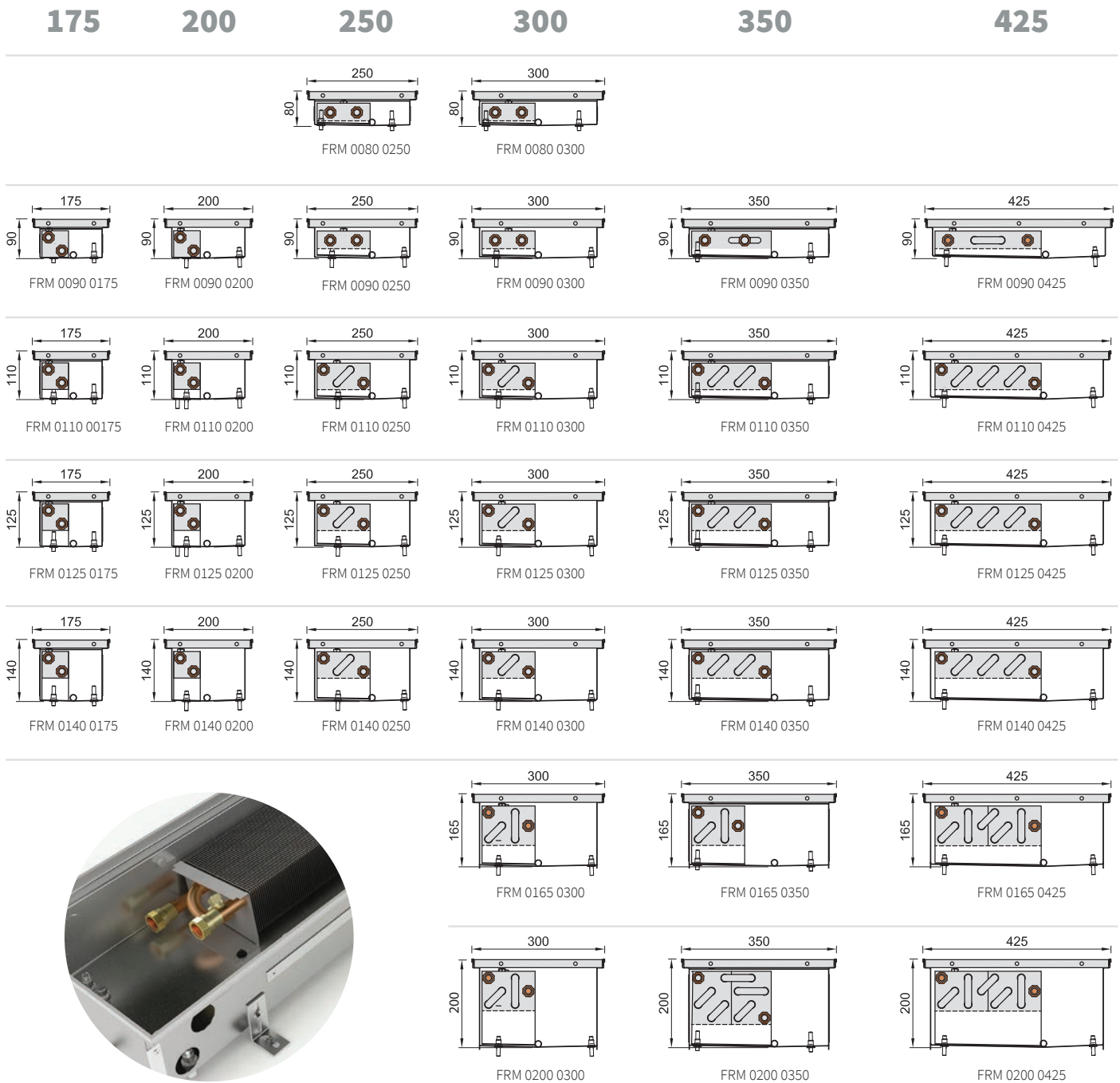

Trench heater heating output FRM

FRM trench heaters have an identical internal arrangement of components as FRK heaters. Their thermal output and other specifications may be found at the dimensionally similar FRK model.

Example:

Heating output FRM 110x250x1600, temperature gradient 75/65/20°C

FRM 0110 0250 1600 = FRK 0110 0250 1600 (page 112)

Temperature gradient: 75/65/20°C

Output: Q = 536 W

Q[W] 75/65/20 °C (ΔT=50 °C)

HxB [mm]	0110 0175	0110 0200	0110 0250	0110 0300	0110 0350	0110 0425
L [mm]	n=1,479	n=1,479	n=1,46	n=1,468	n=1,458	n=1,403
700	103 W	110 W	166 W	182 W	194 W	245 W
800	129 W	137 W	207 W	227 W	242 W	305 W
900	155 W	164 W	248 W	272 W	290 W	365 W
1000	180 W	191 W	289 W	316 W	338 W	425 W
1100	206 W	218 W	330 W	361 W	386 W	486 W
1200	232 W	246 W	371 W	406 W	434 W	546 W
1300	257 W	273 W	413 W	451 W	482 W	607 W
1400	282 W	299 W	454 W	496 W	530 W	667 W

Heat exchanger – Hydraulic resistance

FRT: 65x175, 65x200, 65x250, 80x175, 80x200, 80x250, 90x175, 90x200, 110x175, 110x200

FRK: 80x250, 80x300, 90x175, 90x200, 90x250, 90x300, 110x175, 110x200, 125x175, 125x200, 140x175, 140x200

Length [mm]	Volume [l]	M – mass rate of flow in piping (kg/h) / R – hydraulic loss in exchanger (kPa)									
		M=40	60	80	100	150	200	250	300	350	400
800	0,2	0,01	0,01	0,03	0,05	0,11	0,22	0,36	0,53	0,75	1,00
1000	0,3	0,01	0,02	0,04	0,06	0,14	0,26	0,42	0,61	0,85	1,14
1500	0,5	0,01	0,03	0,06	0,09	0,20	0,36	0,57	0,82	1,12	1,47
2000	0,6	0,02	0,05	0,08	0,12	0,27	0,47	0,72	1,03	1,40	1,81
2500	0,8	0,03	0,06	0,10	0,15	0,33	0,57	0,87	1,24	1,67	2,15
3000	1,0	0,03	0,07	0,12	0,18	0,39	0,68	1,03	1,45	1,94	2,49
3500	1,2	0,04	0,08	0,14	0,22	0,46	0,78	1,18	1,66	2,21	2,83
4000	1,4	0,05	0,10	0,16	0,25	0,52	0,88	1,33	1,86	2,48	3,17
4500	1,6	0,05	0,11	0,19	0,28	0,59	0,99	1,49	2,07	2,75	3,50
4800	1,7	0,06	0,12	0,20	0,30	0,62	1,05	1,58	2,20	2,91	3,71

FRT: 65x300, 80x300

FRK: 90x350

Length [mm]	Volume [l]	M – mass rate of flow in piping (kg/h) / R – hydraulic loss in exchanger (kPa)									
		M=40	60	80	100	150	200	250	300	350	400
800	0,3	0,00	0,01	0,02	0,03	0,09	0,16	0,27	0,40	0,56	0,75
1000	0,4	0,01	0,01	0,03	0,04	0,10	0,19	0,31	0,46	0,64	0,85
1500	0,7	0,01	0,02	0,04	0,07	0,15	0,27	0,43	0,62	0,84	1,11
2000	1,0	0,02	0,03	0,06	0,09	0,20	0,35	0,54	0,77	1,05	1,36
2500	1,3	0,02	0,04	0,08	0,11	0,25	0,43	0,66	0,93	1,25	1,61
3000	1,6	0,03	0,05	0,09	0,14	0,30	0,51	0,77	1,09	1,45	1,87
3500	1,9	0,03	0,06	0,11	0,16	0,34	0,59	0,89	1,24	1,65	2,12
4000	2,2	0,04	0,07	0,12	0,19	0,39	0,66	1,00	1,40	1,86	2,37
4500	2,5	0,04	0,08	0,14	0,21	0,44	0,74	1,11	1,55	2,06	2,63
4800	2,7	0,04	0,09	0,15	0,22	0,47	0,79	1,18	1,65	2,18	2,78

FRT: 90x250, 110x250, 125x250, 125x300, 140x250, 140x300

FRK: 90x425, 110x250, 110x300, 125x250, 125x300, 140x250, 140x300

Length [mm]	Volume [l]	M – mass rate of flow in piping (kg/h) / R – hydraulic loss in exchanger (kPa)									
		M=40	60	80	100	150	200	250	300	350	400
800	0,4	0,02	0,04	0,07	0,10	0,23	0,40	0,62	0,88	1,20	1,55
1000	0,5	0,02	0,05	0,08	0,12	0,27	0,47	0,73	1,04	1,40	1,81
1500	0,9	0,03	0,07	0,12	0,18	0,38	0,66	1,01	1,43	1,91	2,46
2000	1,3	0,04	0,09	0,15	0,23	0,49	0,85	1,29	1,81	2,42	3,11
2500	1,7	0,05	0,11	0,19	0,29	0,61	1,03	1,57	2,20	2,93	3,76
3000	2,1	0,06	0,13	0,22	0,34	0,72	1,22	1,85	2,59	3,44	4,40
3500	2,5	0,07	0,15	0,26	0,39	0,83	1,41	2,12	2,97	3,95	5,05
4000	2,9	0,08	0,17	0,30	0,45	0,94	1,59	2,40	3,36	4,46	5,70
4500	3,3	0,09	0,20	0,33	0,50	1,05	1,78	2,68	3,75	4,97	6,35
4800	3,5	0,10	0,21	0,35	0,53	1,12	1,89	2,85	3,98	5,28	6,74

FRT: 90x300, 110x300**FRK: 165x300, 200x300, 110x350, 125x350, 140x350**

Length [mm]	Volume [l]	M – mass rate of flow in piping (kg/h) / R – hydraulic loss in exchanger (kPa)									
		M=40	60	80	100	150	200	250	300	350	400
800	0,6	0,03	0,06	0,11	0,17	0,35	0,61	0,92	1,29	1,72	2,21
1000	0,8	0,04	0,08	0,13	0,20	0,43	0,72	1,09	1,53	2,03	2,59
1500	1,4	0,06	0,12	0,20	0,29	0,61	1,02	1,53	2,12	2,79	3,55
2000	2,0	0,08	0,16	0,26	0,39	0,79	1,32	1,96	2,71	3,56	4,51
2500	2,6	0,10	0,20	0,32	0,48	0,98	1,62	2,39	3,30	4,32	5,46
3000	3,1	0,12	0,23	0,39	0,57	1,16	1,91	2,83	3,89	5,09	6,42
3500	3,7	0,14	0,27	0,45	0,66	1,34	2,21	3,26	4,48	5,85	7,38
4000	4,3	0,15	0,31	0,51	0,76	1,52	2,51	3,69	5,07	6,62	8,34
4500	4,9	0,17	0,35	0,58	0,85	1,71	2,81	4,13	5,66	7,38	9,30
4800	5,2	0,19	0,37	0,61	0,90	1,82	2,99	4,39	6,01	7,84	9,87

FRT: 90x425, 110x425, 125x425, 140x425**FRK: 110x425, 125x425, 140x425**

Length [mm]	Volume [l]	M – mass rate of flow in piping (kg/h) / R – hydraulic loss in exchanger (kPa)									
		M=40	60	80	100	150	200	250	300	350	400
800	0,8	0,04	0,09	0,15	0,23	0,48	0,81	1,21	1,68	2,23	2,84
1000	1,1	0,05	0,11	0,19	0,28	0,58	0,97	1,44	2,00	2,63	3,34
1500	1,9	0,08	0,17	0,27	0,41	0,83	1,37	2,02	2,78	3,65	4,61
2000	2,6	0,11	0,22	0,36	0,53	1,07	1,77	2,60	3,57	4,66	5,88
2500	3,4	0,14	0,27	0,45	0,66	1,32	2,17	3,18	4,36	5,68	7,15
3000	4,2	0,16	0,33	0,54	0,79	1,57	2,57	3,77	5,14	6,70	8,41
3500	5,0	0,19	0,38	0,62	0,91	1,82	2,97	4,35	5,93	7,71	9,68
4000	5,7	0,22	0,44	0,71	1,04	2,07	3,37	4,93	6,72	8,73	10,95
4500	6,5	0,25	0,49	0,80	1,17	2,32	3,77	5,51	7,50	9,74	12,22
4800	7,0	0,26	0,52	0,85	1,24	2,47	4,02	5,86	7,98	10,35	12,98

FRT: -**FRK: 165x425, 200 x 350, 200x425**

Length [mm]	Volume [l]	M – mass rate of flow in piping (kg/h) / R – hydraulic loss in exchanger (kPa)									
		M=40	60	80	100	150	200	250	300	350	400
800	1,2	0,07	0,14	0,24	0,35	0,72	1,20	1,77	2,44	3,21	4,06
1000	1,6	0,09	0,18	0,29	0,43	0,87	1,44	2,12	2,91	3,81	4,81
1500	2,8	0,13	0,26	0,42	0,62	1,24	2,03	2,99	4,09	5,32	6,70
2000	4,0	0,17	0,34	0,55	0,81	1,61	2,63	3,85	5,26	6,84	8,59
2500	5,1	0,21	0,42	0,68	1,00	1,98	3,23	4,72	6,43	8,35	10,47
3000	6,3	0,25	0,50	0,81	1,19	2,35	3,83	5,58	7,60	9,86	12,36
3500	7,5	0,29	0,58	0,94	1,38	2,72	4,43	6,45	8,77	11,38	14,25
4000	8,7	0,34	0,66	1,07	1,56	3,10	5,02	7,31	9,94	12,89	16,14
4500	9,8	0,38	0,74	1,21	1,75	3,47	5,62	8,18	11,11	14,40	18,02
4800	10,5	0,40	0,79	1,28	1,87	3,69	5,98	8,70	11,82	15,31	19,16

Heat exchanger – Hydraulic resistance

FRC 0100 0175, 2 pipe

Length [mm]	Volume [l]	M – mass rate of flow in piping (kg/h) / R – hydraulic loss in exchanger (kPa)									
		M=40	60	80	100	150	200	250	300	350	400
800	0,3	0,45	0,91	1,51	2,23	4,54	7,50	11,08	15,24	19,96	25,21
1200	0,4	0,72	1,46	2,41	3,57	7,26	12,02	17,76	24,45	32,02	40,46
1600	0,5	0,98	2,00	3,32	4,90	9,98	16,53	24,44	33,65	44,09	55,72
2000	0,7	1,25	2,55	4,22	6,24	12,71	21,04	31,13	42,85	56,16	70,98
2400	0,8	1,52	3,09	5,12	7,58	15,43	25,56	37,81	52,06	68,23	86,24
2800	1,0	1,78	3,64	6,02	8,91	18,15	30,07	44,49	61,26	80,29	101,49

FRC 0135 0325, 2 pipe

Length [mm]	Volume [l]	M – mass rate of flow in piping (kg/h) / R – hydraulic loss in exchanger (kPa)									
		M=40	60	80	100	150	200	250	300	350	400
800	0,5	0,13	0,27	0,44	0,66	1,34	2,23	3,32	4,58	6,01	7,61
1200	0,9	0,20	0,42	0,70	1,04	2,12	3,53	5,24	7,23	9,50	12,03
1600	1,3	0,27	0,55	0,91	1,36	2,78	4,62	6,86	9,47	12,44	15,75
2000	1,7	0,33	0,67	1,11	1,64	3,37	5,60	8,31	11,47	15,07	19,08
2400	2,1	0,38	0,77	1,29	1,91	3,91	6,50	9,65	13,32	17,49	22,15
2800	2,5	0,43	0,87	1,45	2,16	4,42	7,34	10,90	15,04	19,76	25,02

FRD 0135 0325, 4 pipe, Heating-circuit

Length [mm]	Volume [l]	M – mass rate of flow in piping (kg/h) / R – hydraulic loss in exchanger (kPa)									
		M=40	60	80	100	150	200	250	300	350	400
800	0,1	0,18	0,36	0,59	0,87	1,77	2,92	4,32	5,94	7,77	9,82
1200	0,2	0,30	0,61	1,01	1,49	3,03	5,00	7,39	10,16	13,31	16,81
1600	0,3	0,41	0,84	1,38	2,04	4,15	6,87	10,14	13,95	18,27	23,07
2000	0,4	0,52	1,05	1,73	2,56	5,20	8,60	12,71	17,48	22,89	28,91
2400	0,5	0,61	1,25	2,07	3,05	6,20	10,25	15,14	20,83	27,27	34,44
2800	0,6	0,71	1,44	2,38	3,52	7,15	11,83	17,47	24,03	31,47	39,74

FRD 0135 0325, 4 pipe, Cooling-circuit

Length [mm]	Volume [l]	M – mass rate of flow in piping (kg/h) / R – hydraulic loss in exchanger (kPa)									
		M=40	60	80	100	150	200	250	300	350	400
800	0,4	0,09	0,20	0,33	0,50	1,04	1,76	2,65	3,69	4,89	6,25
1200	0,7	0,15	0,32	0,54	0,81	1,70	2,88	4,33	6,04	8,01	10,22
1600	1,0	0,20	0,43	0,72	1,09	2,28	3,85	5,79	8,08	10,71	13,66
2000	1,3	0,25	0,53	0,89	1,34	2,80	4,74	7,12	9,93	13,16	16,80
2400	1,6	0,29	0,62	1,04	1,57	3,29	5,56	8,36	11,66	15,45	19,72
2800	1,9	0,34	0,70	1,19	1,79	3,75	6,34	9,53	13,30	17,62	22,49

Flow diagrams for thermostatic valves Z-TD001, Z-TE001, Z-LE001

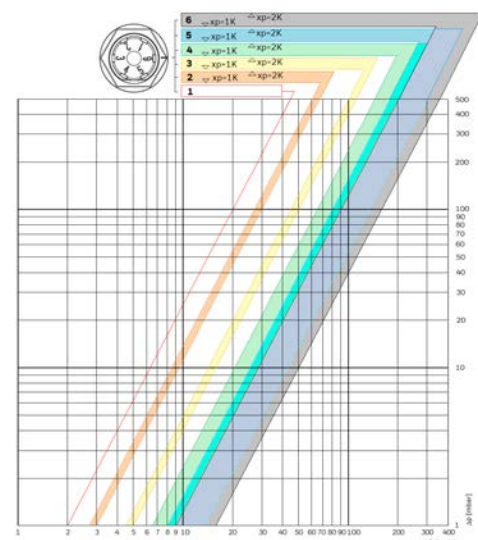
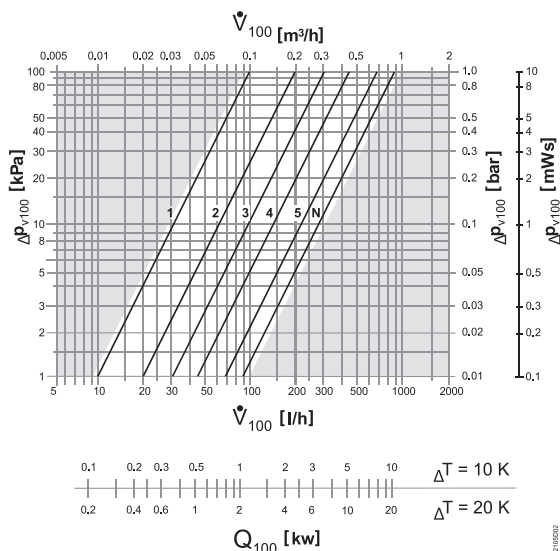

Electric connection of trench heaters with fan, heating

The trench heaters and their components are powered with safe direct current voltage of 24 V DC. The low voltage requires specific sizing of the network. Based on the number of installed units it is necessary to assess the total input of the circuit and size the capacity of the power source and the cross sections of the conductors in the circuit shall be correctly sized with respect to the distances between individual heating bodies and the switched source of the voltage of 24 V DC. The total input of the bodies is considered for maximal speed (i.e. speed no. 4), if the electrothermal actuator is used we will add its operating input. The voltage in the circuit may not, in any point, drop below the value of 22 V DC.

Procedure of the network sizing

1. Consider the trench heater's input for maximal speed from the table.
2. If the electrothermal actuator is considered, add its input.
3. Determine the position for the installation of the switched power supply for the voltage of 24 V DC, this position shall be as close to installed trench heaters as possible.
4. Record the distances between the bodies and the source from the project.
5. Determine the lines of the electric network.
6. Calculate the decline of voltage in individual bodies.
7. If the voltage at all heating bodies is >22 V DC, determine the power supply's capacity, consider the output reserve of 5% (see SCHEME 1 on page 130).
8. If the voltage along the network lines drops below 22 V DC, size a large cross section of conductors or install additional power supply on the lines (see SCHEME 3 on page 131).
9. When installing more than 10 trench heaters it is necessary to incorporate a switching relay RL10 in the circuit, (see SCHEME 2 on page 130).

Setting the thermostat, heating and heating / cooling

The thermostat requires an initial setup for proper operation. Set the **DIP switch** on the back of the thermostat to the correct position. After start-up, set the thermostat parameters. See the settings table below for more information.

The parameters can now be conveniently configured using the **PCT Go** app, available on **Google Play** and the **App Store**. An **NFC-capable SMART** phone is required for proper operation. To set up **PCT Go** applications, all **DIP switches** must be in the **OFF** position.



For basic models, set the parameters as follows:

Heating, 2-pipe

DIP 1	ON, 2 - 9 OFF
P001 = 0	only heating
P031 = 1-15	language
P357 = 20 %	min. speed
P358 = 60 %	mid. speed
P359 = 99 %	max. speed
P400 = 2	actuator Z-TS24 (at Q1 and G0 terminals)

If the **TE30** heat exchanger temperature sensor is installed at X2 and M terminals:

P153 = 12	temperature reading
P366 = 30	switching temperature, 5 to 60 °C range

Heating / Cooling, 2-pipe

DIP1	ON, 2-9 OFF
P001 = 2	heating / cooling auto (TE30 at X2 and G0)
P001 = 3	heating / cooling manual
P031 = 1-15	language
P357 = 20 %	min. speed
P358 = 60 %	mid. speed
P359 = 99 %	max. speed
P400 = 2	actuator Z-TS24 heating / cooling (at Q1 and G0 terminals)

If the **TE30** heat exchanger temperature sensor is installed at X2 and M terminals (with parameter P001 = 2):

P153 = 2	heating / cooling changeover
-----------------	------------------------------

Heating / cooling, 4-pipe

DIP	1-2 OFF, 3 ON, 4-9 OFF
P001 = 4	heating / cooling
P031 = 1-15	language
P357 = 20 %	min. speed
P358 = 60 %	mid. speed
P359 = 99 %	max. speed
P400 = 3	actuator Z-TS24 heating (at Q1 and G0 terminals)
P401 = 4	actuator Z-TS24 cooling (at Q2 and G0 terminals)

Other parameters for the RTD210 thermostat (Siemens RDG260T) can be found on the Siemens website

Electrical diagrams, heating and heating / cooling, 2-pipe, RTD201

SCHEME 1 - basic connection

Note

- › The voltage must not drop below 22 V DC, it is necessary to size the cross section of conductors correctly according to the calculation SW.
- › If more than 10 electrothermal actuators are used it is necessary to use the switching relay (see SCHEME 2).
- › If the capacity of the switching source is insufficient use more power supplies (see SCHEME 3).
- › Pay attention to the correct polarity! Reversing the polarity may cause irreversible damage.
- › Pay attention to the correct polarity! Reversing the polarity may cause irreversible damage.

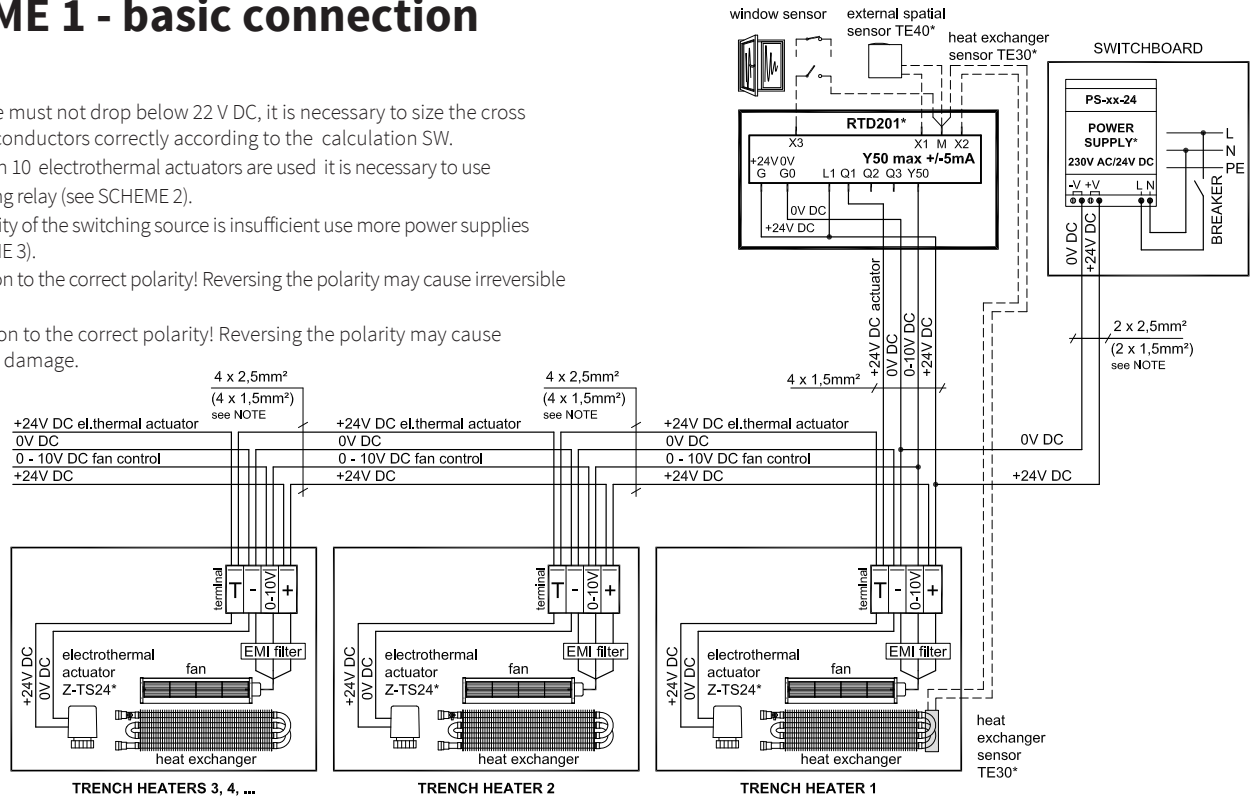

* accessories

** if all DIP switches are OFF, it is possible to set the thermostat using NFC (PCT Go application on Google Play and App Store)

SCHEME 2 - connection with more than 10pcs of electrothermal

Note

- › The voltage must not drop below 22 V DC, it is necessary to size the cross section of conductors correctly according to the calculation SW.
- › If the capacity of the switching source is insufficient use more power supplies (see SCHEME 3).

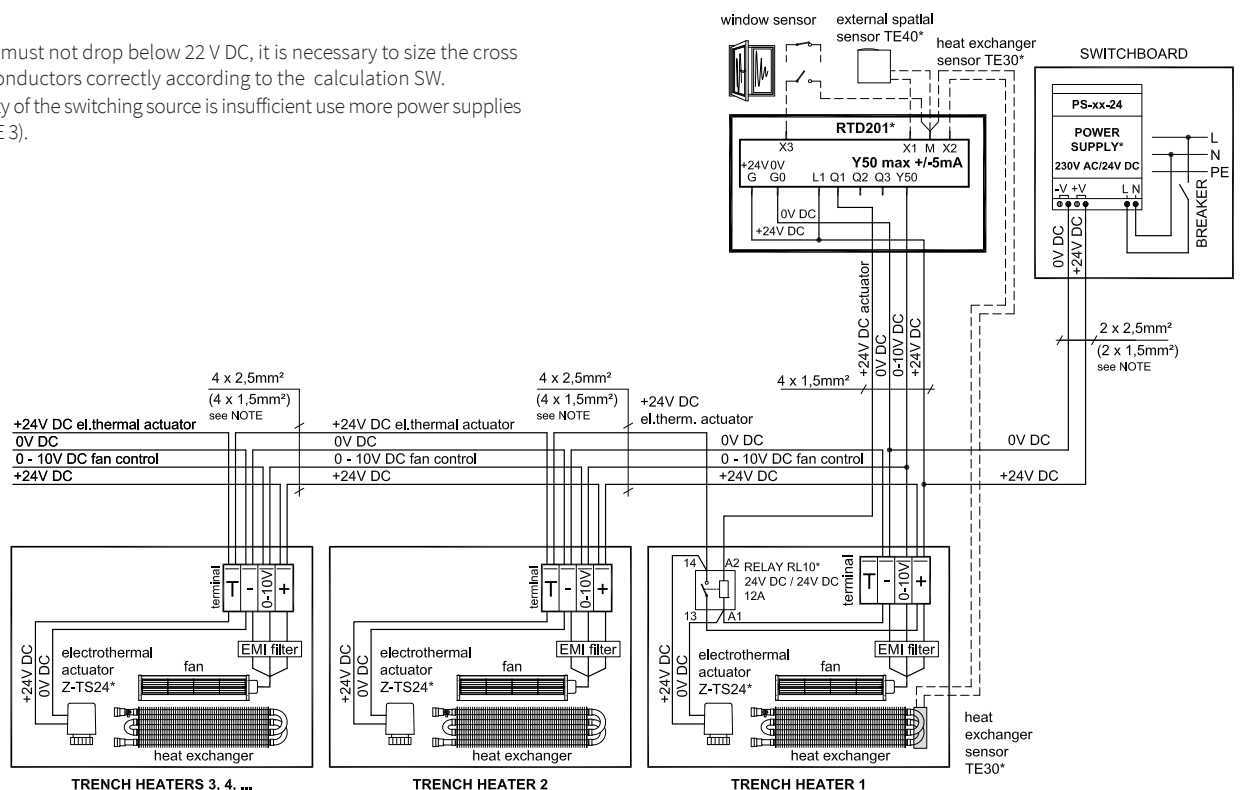

* accessories

** if all DIP switches are OFF, it is possible to set the thermostat using NFC (PCT Go application on Google Play and App Store)

SCHEME 3 - connection with more supplies

Note

- › The voltage must not drop below 22 V DC, it is necessary to size the cross section of conductors correctly according to the calculation SW.
- › If more than 10 electrothermal actuators are used it is necessary to use the switching relay (see DIAGRAM 2).
- › All sources shall be powered from a single circuit breaker.
- › Pay attention to the correct polarity! Reversing the polarity may cause irreversible damage.

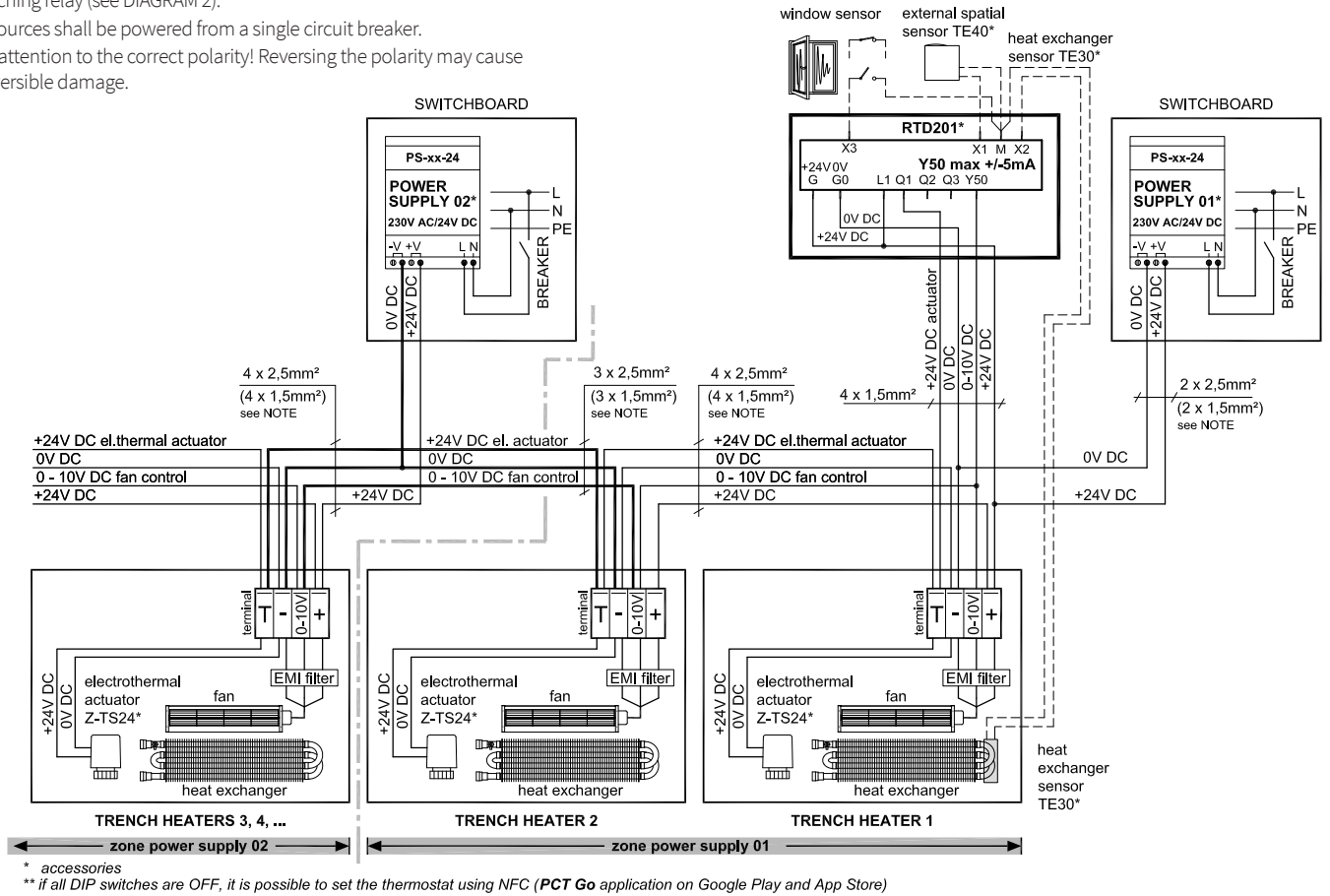

RTM201 thermostat connection, heating and heating / cooling

- › The RTM201 thermostat is to be installed in accordance with RTD201 digital thermostat wiring diagrams, including the required parameters.
- › Preview of wiring connections to RTM201 thermostat terminals

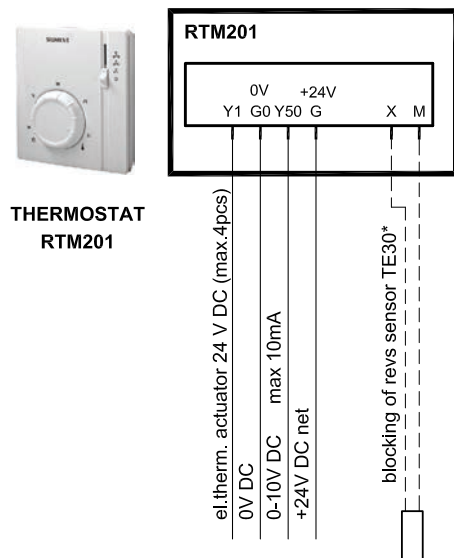
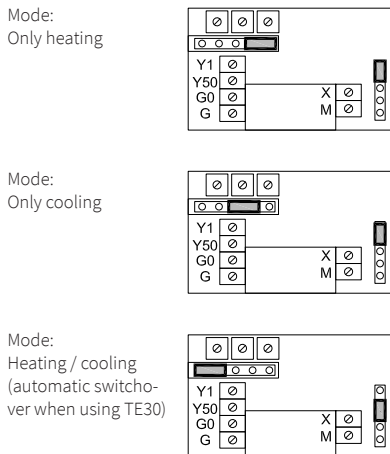

Note: The RTM201 thermostat can only control 4 electrothermal actuators, for more units use the RL10 relay, connection according to Diagram 2
 *Accessories

The coding of trench heaters TERMO

1	2	3	4	5	6	7	8	9	10	11	12	13	14	15	16	17	18	19	20	21	22	23	24
F	R	T	0	1	1	0	0	2	5	0	1	2	0	0	C	1	2	J	1	L	B	5	
PRODUCT	LINE	TYPE	HEIGHT [MM]			WIDTH [MM]				LENGTH [MM]				TROUGH & COMPONENTS	GRILLE, TYPE AND COLOUR		LEDGE COLOUR OF LEDGE	WATER CONNECTION LEFT / RIGHT		SELF-STANDING	REGULATION	ATYPICAL / STANDARD	

Code description

Trench heater **FRT** H = 110 mm, W = 250 mm, L = 1 200 mm, „**C**“ Galvanized steel trough with black inside, heat exchanger and inner parts painted black, „**12**“ natur anodized aluminium grille, linear, rigid „**J1**“ peripheral ledge „**J**“, natur anodized aluminium, „**L**“ water connection at the left side (when installing the heat exchanger closer to the window, fans to the room), „**B**“ self-standing 0-35 mm „**5**“ 24 V DC fans without controller (controller is not needed)

1-3	PRODUCT	for examp. FRT	<p>Fan-assisted</p> <p>FET - with electric heating unit FRT - with lamellar heat exchanger, heating FRC - with lamellar heat exchanger, heating / cooling, 2 pipe FRD - with lamellar heat exchanger, heating / cooling, 4 pipe FRB - with lamellar heat exchanger, heating, humid environment FRZ - trench heater FRT with installed power supply FZC - trench heater FRC with installed power supply FZD - trench heater FRD with installed power supply</p> <p>Natural convection</p> <p>FEK - with electric heating unit FRK - trench heater with lamellar heat exchanger FRM - trench heater with lamellar heat exchanger, humid environment</p>
4-7	HEIGHT [mm]	for examp. 0090	<p>FET 0110 FRT 0065, 0080, 0110, 0125, 0140 FRC, FRD, FZC, FRD 0100, 0325 FRB 0090, 0110, 0125, 0140 FEK 0140 FRK, FRM 0080, 0090, 0110, 0125, 0140, 0200</p>
8-11	WIDTH [mm]	for examp. 0175	<p>FET, FEK 0225 FRT, FRZ 0175, 0200, 0250, 0300, 0425 mm FRC, FZC 0175, 0325 mm FRD, FZD 0325 mm FRB 0200, 0250, 0300, 0425 mm FRK, FRM 0175, 0200, 0250, 0300, 0350, 0425 mm</p>
12-15	LENGTH [mm]	700 to 4800	<p>FET, FEK 800, 1200, 1600, 2000 mm</p> <p>FRT, FRB, FRK, FRM 0700, 0800, 0900, 1000, 1100, 1200, 1300, 1400, 1500, 1600, 1700, 1800, 1900, 2000, 2100, 2200, 2300, 2400, 2500, 2600, 2700, 2800, 2900, 3000, 3100, 3200, 3300, 3400, 3500, 3600, 3700, 3800, 3900, 4000, 4100, 4200, 4300, 4400, 4500, 4600, 4700, 4800 mm</p> <p>FRZ, FDZ - the length of the trench heater is 200 mm longer than FRT and FDT</p> <p>FRC, FRD 0800, 1200, 1600, 2000, 2400, 2800 mm</p> <p>FZC, FZD model 0100 0175 longer 200 mm, 0135 0325 the same length as FRC, FRD</p>
16	TROUGH & INNER COMPONENTS	C	Galvanized steel trough with surface finish and black spray layer inside
		N	Trough made of stainless steel

17-18	GRILLES	00	WITHOUT THE GRILLE, the trench heater without the grille (the customer will supply their own grille or buy one later)
		11	NATUR aluminium roll-up transverse grille
		12	NATUR aluminium linear non-rolling grille
		15	NATUR aluminium low transverse grille
		17	NATUR for electric heaters, transverse aluminium non-roll grille
		21	BRONZE aluminium roll-up transverse grille
		22	BRONZE aluminium linear non-rolling grille
		25	BRONZE aluminium low transverse grille
		27	BRONZE for electric heaters, transverse aluminium non-roll grille
		31	BLACK aluminium roll-up transverse grille
		32	BLACK aluminium linear non-rolling grille
		35	BLACK aluminium low transverse grille
		37	BLACK for electric heaters, transverse aluminium non-roll grille
		41	STAINLESS aluminium roll-up transverse grille
		42	STAINLESS aluminium linear non-rolling grille
		47	STAINLESS for electric heaters, transverse aluminium non-roll grille
		51	STAINLESS non-rolling transverse grille of stainless steel profiles 20×10 mm (for car saloons)
		52	STAINLESS roll-up transverse grille of stainless steel profiles 20×10 mm
		61	BEECH NATUR wooden roll-up transverse grille without surface finish
		62	STAINED BEECH wooden roll-up transverse grille with stained surface finish
63	OAK NATUR wooden roll-up transverse grille without surface finish		
64	STAINED OAK wooden roll-up transverse grille with stained surface finish		
95	STAINLESS highly resistant grille		
99	ATYP - material, spacing of lamellas, surface finish according to RAL, after consultation with ISAN		
19	LEDGE	-	WITHOUT LEDGE - in the case of additional order (if the trench heater is embedded without the ledge, say so in the note, in such case the grille's width is different)
		L	L - peripheral ledge 15×15×1,5 mm to cover expansion gaps, the position of the code 20 determines the surface finish
		J	J - peripheral ledge that forms a peripheral rectangle with the width of 4 mm
20	COLOUR OF LEDGE	-	in the case when the ledge is not installed
		1	NATUR anodized aluminium ledge
		2	BRONZE anodized aluminium ledge
		3	BLACK anodized aluminium ledge
		9	other colour, i.e surface finish of sprayed powder colour according to the RAL sample list
21	CONNECTION RIGHT/LEFT	L	Connection of the heating medium ON THE LEFT side when installing the heat exchanger at the window, the fan towards the room's centre (standard)
		R	Connection of the heating medium ON THE RIGHT side when installing the heat exchanger at the window, the fan towards the room's centre (Version R electric heaters only)
		A	OTHER, e.g. the left/right connection into the bottom, with combined trench heaters connection in the middle etc.
22	SELF-STANDING	-	STANDARD adjusting components are not load bearing and should be used for height adjustment only
		B	ADJUSTING SCREWS 0-35 mm, closely spaced screws on the bottom of the heater casing, load-bearing
		D	ADJUSTING LEGS, a supporting legs fitted with a leveling screw
		V	BRACKETS 60-300 mm, special „leg“ mounting
23	REGULATION	0	FRK, trench heater without fans (with natural convection)
		1	FEK - trench heater without fan with installed regulator
		5	FRT, 24 V DC fans installed
		6	FET - 24 V DC fans and regulators installed
		P	FRC, FRD, FZC, FZD - 24 V DC fans installed + condensate pump CP10
24	ATYPICAL		Empty field, standard version of the trench heater
		A	Atypical version of the trench heater



ISAN Radiátory s.r.o

Poříčí 26
678 01 Blansko
Česká republika

CZ

+420 516 489 138
obchod@isan.cz

SK

+420 516 489 186
obchod@isan.sk

Export

+420 516 489 190
sales@isan.cz