

PRISER GÆLDENDE PR. 01.04.2013

PANELRADIATORER



4 TYPE 11

= Lagervarer

Lgd/mm	Hd/mm	300	400	500	600	900
300	Kr.	542,-	591,-	613,-	644,-	919,-
	Watt:	109	121	146	170	234
400	Kr.	542,-	591,-	613,-	644,-	919,-
	Watt:	125	161	194	226	310
500	Kr.	590,-	635,-	654,-	694,-	990,-
	Watt:	155	201	243	282	387
600	Kr.	649,-	692,-	744,-	765,-	1116,-
	Watt:	187	241	291	339	464
700	Kr.	698,-	762,-	825,-	931,-	1260,-
	Watt:	218	281	340	396	542
800	Kr.	747,-	832,-	932,-	992,-	1404,-
	Watt:	249	321	389	452	619
900	Kr.	796,-	938,-	1044,-	1104,-	1580,-
	Watt:	280	362	437	508	697
1000	Kr.	906,-	1041,-	1134,-	1251,-	1753,-
	Watt:	311	402	486	565	774
1100	Kr.	998,-	1167,-	1293,-	1322,-	1882,-
	Watt:	342	442	535	621	851
1200	Kr.	1050,-	1245,-	1341,-	1414,-	2011,-
	Watt:	373	482	583	678	929
1400	Kr.	1176,-	1434,-	1513,-	1661,-	2347,-
	Watt:	435	563	680	791	1083
1500	Kr.	1304,-	1545,-	1571,-	1781,-	2543,-
	Watt:	467	603	729	848	1161
1600	Kr.	1365,-	1573,-	1675,-	1841,-	2680,-
	Watt:	497	643	778	904	1238
1800	Kr.	1560,-	1698,-	1961,-	2118,-	3009,-
	Watt:	560	723	875	1017	1393
2000	Kr.	1715,-	1916,-	2129,-	2348,-	3338,-
	Watt:	622	804	972	1130	1548
2200	Kr.	1856,-	2157,-	2346,-	2540,-	3690,-
	Watt:	684	884	1069	1243	1703
2500	Kr.	2111,-	2373,-	2654,-	2825,-	4293,-
	Watt:	777	1005	1215	1412	1935
2600	Kr.	2335,-	2597,-	2880,-	3065,-	4519,-
	Watt:	809	1045	1264	1469	2012
3000	Kr.	2556,-	2821,-	3103,-	3304,-	4885,-
	Watt:	933	1206	1458	1695	2322

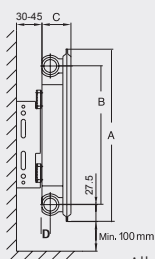

Temperatursæt 70/40/20

Anboringer: 4 x 1/2"
 Farve: RAL 9016
 Max. driftstryk: 10 bar.
 Prøvetryk: 13 bar.
 L-vægkonsol: 2 afstandsmuligheder:
 30 eller 45 mm

A	300	400	500	600	900
B	245	345	445	545	845
C	50				
D	17				

Alle tal er mm

Alle radiatorer leveres med vægkonsoller, luftskruer og prop.

TYPE 22

 = Lagervarer **5**

Lgd/mm	Hd/mm	300	400	500	600	900
300	Kr.	874,-	968,-	1010,-	1074,-	1543,-
	Watt:	188	238	284	326	435
400	Kr.	874,-	968,-	1010,-	1074,-	1543,-
	Watt:	250	318	380	437	584
500	Kr.	912,-	1003,-	1068,-	1135,-	1662,-
	Watt:	312	397	474	546	730
600	Kr.	993,-	1076,-	1149,-	1316,-	1950,-
	Watt:	375	476	569	656	876
700	Kr.	1157,-	1269,-	1351,-	1519,-	2239,-
	Watt:	438	556	664	765	1022
800	Kr.	1261,-	1546,-	1511,-	1652,-	2493,-
	Watt:	500	635	759	874	1168
900	Kr.	1404,-	1637,-	1669,-	1885,-	2560,-
	Watt:	563	715	854	984	1314
1000	Kr.	1550,-	1761,-	1810,-	2069,-	3139,-
	Watt:	625	794	949	1093	1460
1100	Kr.	1682,-	1865,-	1997,-	2262,-	3415,-
	Watt:	682	873	1044	1202	1606
1200	Kr.	1772,-	1964,-	2099,-	2393,-	3749,-
	Watt:	750	953	1139	1312	1752
1400	Kr.	2035,-	2250,-	2407,-	2817,-	4312,-
	Watt:	875	1112	1328	1530	2044
1500	Kr.	2165,-	2446,-	2609,-	3017,-	4588,-
	Watt:	937	1191	1423	1640	2190
1600	Kr.	2313,-	2604,-	2744,-	3184,-	4824,-
	Watt:	1000	1270	1518	1749	2336
1800	Kr.	2524,-	2861,-	3074,-	3513,-	5343,-
	Watt:	1125	1429	1708	1967	2628
2000	Kr.	2782,-	3246,-	3425,-	3929,-	5990,-
	Watt:	1250	1588	1898	2186	2920
2200	Kr.	3269,-	3532,-	3874,-	4559,-	6751,-
	Watt:	1375	1747	2088	2405	3212
2500	Kr.	3558,-	3929,-	4278,-	5048,-	7512,-
	Watt:	1562	1985	2372	2732	3650
2600	Kr.	3710,-	4095,-	4769,-	5307,-	7815,-
	Watt:	1625	2064	2467	2842	3796
3000	Kr.	4230,-	4701,-	5116,-	6234,-	9180,-
	Watt:	1875	2382	2847	3279	4386

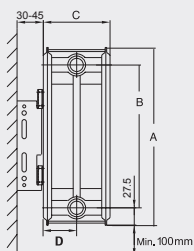

Temperatursæt 70/40/20

Anboringer: 4 x 1/2"
 Farve: RAL 9016
 Max. driftstryk: 10 bar.
 Prøvetryk: 13 bar.
 L-vægkonsol: 2 afstandsmuligheder:
 30 eller 45 mm

A	300	400	500	600	900
B	245	345	445	545	845
C	104				
D	52,5				

Alle tal er mm

Alle priser er bruttopriser ex. moms. Ret til ændringer forbeholdes.

6 TYPE 33

= Lagervarer

Lgd/mm	Hd/mm	300	400	500	600	900
300	Kr.	1090,-	1315,-	1357,-	1529,-	2148,-
	Watt:	269	340	405	466	635
400	Kr.	1090,-	1315,-	1357,-	1529,-	2148,-
	Watt:	356	452	542	626	852
500	Kr.	1254,-	1513,-	1557,-	1773,-	2396,-
	Watt:	446	565	678	783	1064
600	Kr.	1378,-	1626,-	1694,-	1913,-	2850,-
	Watt:	535	679	814	940	1277
700	Kr.	1535,-	1667,-	1942,-	2189,-	3338,-
	Watt:	624	764	949	1096	1490
800	Kr.	1673,-	2007,-	2190,-	2464,-	3699,-
	Watt:	713	905	1085	1253	1703
900	Kr.	1852,-	2043,-	2449,-	2800,-	4157,-
	Watt:	802	1018	1220	1409	1916
1000	Kr.	2030,-	2447,-	2709,-	3116,-	4589,-
	Watt:	891	1131	1356	1566	2129
1100	Kr.	2175,-	2688,-	2894,-	3404,-	5002,-
	Watt:	980	1284	1492	1723	2342
1200	Kr.	2322,-	2929,-	3078,-	3692,-	5414,-
	Watt:	1069	1357	1627	1879	2555
1400	Kr.	2702,-	3295,-	3612,-	4268,-	6086,-
	Watt:	1247	1583	1898	2192	2981
1500	Kr.	2980,-	3502,-	3880,-	4557,-	6758,-
	Watt:	1336	1697	2034	2349	3193
1600	Kr.	3320,-	3799,-	4220,-	4821,-	7315,-
	Watt:	1426	1810	2170	2506	3406
1800	Kr.	3702,-	4194,-	4878,-	5339,-	7872,-
	Watt:	1604	2036	2441	2819	3832
2000	Kr.	3931,-	4696,-	5098,-	5849,-	9193,-
	Watt:	1782	2262	2712	3132	4258
2200	Kr.	4668,-	5183,-	5618	6446,-	10139,-
	Watt:	1960	2488	2983	3445	4684
2500	Kr.	5143,-	5823,-	6375,-	7428,-	11674,-
	Watt:	2228	2827	3390	3915	5323
2600	Kr.	5758,-	6431,-	7073,-	7755,-	12188,-
	Watt:	2317	2941	3526	4072	5535
3000	Kr.	6373,-	7038,-	7772,-	8807,-	13837,-
	Watt:	2673	3393	4068	4698	6387

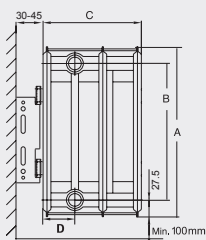

Temperatursæt 70/40/20

Anboringer: 4 x 1/2"
 Farve: RAL 9016
 Max. driftstryk: 10 bar.
 Prøvetryk: 13 bar.
 L-vægkonsol: 2 afstandsmuligheder:
 30 eller 45 mm

A	300	400	500	600	900
B	245	345	445	545	845
C	160				
D	52,5				

Alle tal er mm

Alle radiatorer leveres med vægkonsoller, luftskruer og prop.

PLAN FRONT = Lagervarer **7**

Lgd/mm	Hd/mm	300	400	500	600	900
300	Kr.	463,-	482,-	530,-	596,-	772,-
400	Kr.	463,-	482,-	530,-	596,-	772,-
500	Kr.	487,-	530,-	571,-	646,-	804,-
600	Kr.	547,-	596,-	646,-	709,-	880,-
700	Kr.	590,-	649,-	715,-	785,-	985,-
800	Kr.	637,-	701,-	771,-	847,-	1027,-
900	Kr.	662,-	772,-	804,-	880,-	1157,-
1000	Kr.	698,-	794,-	831,-	939,-	1416,-
1100	Kr.	745,-	830,-	900,-	1000,-	1540,-
1200	Kr.	800,-	887,-	939,-	1078,-	1690,-
1400	Kr.	920,-	1015,-	1085,-	1271,-	1945,-
1500	Kr.	980,-	1103,-	1178,-	1361,-	2069,-
1600	Kr.	1046,-	1174,-	1237,-	1436,-	2176,-
1800	Kr.	1143,-	1290,-	1388,-	1584,-	2410,-
2000	Kr.	1255,-	1464,-	1545,-	1770,-	2701,-
2200	Kr.	1473,-	1593,-	1748,-	2057,-	2952,-
2500	Kr.	1605,-	1772,-	1930,-	2278,-	3389,-
2600	Kr.	1749,-	1882,-	2152,-	2393,-	3619,-
3000	Kr.	1906,-	2120,-	2308,-	2812,-	4292,-



Farve RAL 9016

Samtlige radiatorer i vores prisliste fås med plan front. Den plane front er ikke vandførende, men klikkes helt enkelt på den traditionelle radiator. Den plane front kan enten bestilles sammen med radiatoren, eller købes separat til bestående anlæg. Ved bestilling af større mængder samt udover lagerprogram, bør der forventes en leveringstid på ca. 6-8 uger.

NB: ved montering af plan front reduceres varmeydelsen med ca. 8%.
Alle priser er bruttopriser ex. moms. Ret til ændringer forbeholdes

VÆGBESLAG

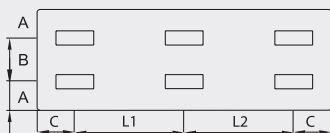
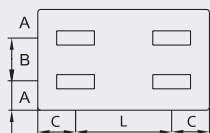

Type 11/22/33

Højde	A	B	C
mm	mm	mm	mm
300	72,5	155	100
400	122,5	155	100
500	122,5	255	100
600	122,5	355	100
900	122,5	655	100

400 – 1400 MM

Type 11, 22 & 33

Længde	L
mm	mm
400	200
500	300
600	400
700	500
800	600
900	760
1000	800
1100	900
1200	1000
1300	1100
1400	1200

1500 – 3000 MM

Type 11, 22 & 33

Længde	L1	L2
mm	mm	mm
1500	666,5	633,5
1600	700	700
1800	800	800
2000	900	900
2200	1000	1000
2500	1166,5	1133,5
2600	1200	1200
2800	1300	1300
3000	1400	1400

VÆGT OG VOLUMEN

Type	Højde (mm)	Vægt (kg/m)	Vand (l/m)
11	300	8,41	1,70
	400	11,42	2,10
	500	14,42	2,50
	600	17,43	2,90
	900	26,44	3,50
22	300	16,42	3,70
	400	22,43	4,10
	500	28,44	5,00
	600	34,45	5,90
	900	52,48	7,60
33	300	24,43	5,00
	400	33,45	6,10
	500	42,46	7,20
	600	51,48	8,30
	900	78,52	11,25

VÆGKONSOLLER

9

L-VÆGKONSOLLER

Som standard leveres alle typer med L-vægkonsol, som er incl. i prisen.

Højde mm	Længde mm
300	177
400	177
500	277
600	377
900	677

Vægkonsollerne leveres komplet med skruer, rawplugs og plastikbeskytter, som illustreret.

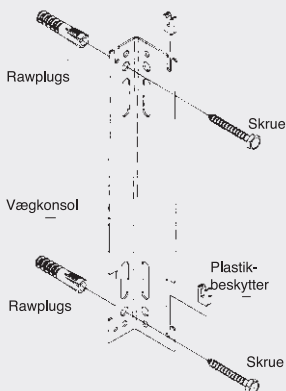

KLIKBÆRINGER

Ønskes klikbæringer frem for L-vægbeslag, kan disse bestilles separat.

Klikbæringer leveres komplet med skruer og rawplugs, som illustreret.



GULVBEN

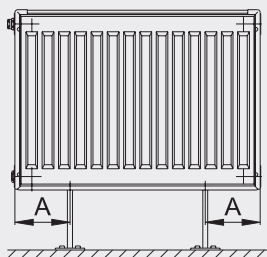

A 112,5 mm

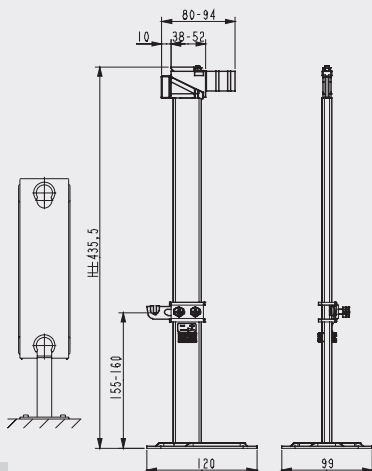

TILBEHØR



Radiatorforskruing - 1/2"

40 5000 004 - lige pr. stk. **kr. 70,-**
40 5001 004 - vinkel pr. stk. **kr. 70,-**



Radiatorforskruing - 1/2" med aftap

40 5000 704 - lige pr. stk. **kr. 65,-**



Danfoss føler

40 3222 100
RA-2990, m/snablås pr. stk. **kr. 350,-**



Danfoss føler

40 3220 000
ECO living pr. stk. **kr. 794,-**



Danfoss ventilhus RA-N - 1/2"

40 3202 004 - lige pr. stk. **kr. 325,-**
40 3203 004 - vinkel pr. stk. **kr. 325,-**



Opførings sæt, Hvid - LANG, kompl.

33 9490 045 pr. stk **kr. 810,-**

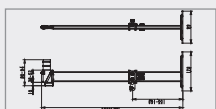

Gulvben t/panelradiatorer

G940 Uni- standard pr. stk. **kr. 345,-**
G940 Raw
- ekstra høj (300 mm) pr. stk. **kr. 436,-**



Rosette t/ gulvben

Ros940Uni pr. stk. **kr. 52,-**



L-vægkonsol

NETTO pr. stk. **kr. 30,-**

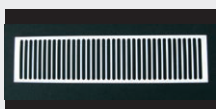

Toprist

TYPE 11, NETTO pr. mtr. **kr. 65,-**
TYPE 22, NETTO pr. mtr. **kr. 85,-**
TYPE 33, NETTO pr. mtr. **kr. 110,-**



Sidegavl

TYPE 11, NETTO pr. stk. **kr. 65,-**
TYPE 22, NETTO pr. stk. **kr. 85,-**
TYPE 33, NETTO pr. stk. **kr. 110,-**